

1. Application

This specifications applies to a color TFT-LCD module, LQ084V2DS01.

- ©These specification sheets are the proprietary product of SHARP CORPORATION("SHARP) and include materials protected under copyright of SHARP. Do not reproduce or cause any third party to reproduce them in any form or by any means, electronic or mechanical, for any purpose, in whole or in part, without the express written permission of SHARP .
- ©The device listed in these specification sheets was designed and manufactured for use in OA equipment .
- ©In case of using the device for applications such as control and safety equipment for transportation(aircraft, trains, automobiles, etc.), rescue and security equipment and various safety related equipment which require higher reliability and safety, take into consideration that appropriate measures such as fail-safe functions and redundant system design should be taken .
- ©Do not use the device for equipment that requires an extreme level of reliability, such as aerospace applications, telecommunication equipment(trunk lines), nuclear power control equipment and medical or other equipment for life support .
- ©SHARP assumes no responsibility for any damage resulting from the use of the device which does not comply with the instructions and the precautions specified in these specification sheets .
- ©Contact and consult with a SHARP sales representative for any questions about this device .

2. Overview

This module is a color reflective and active matrix LCD module, named HR-TFT (High Reflective-TFT), incorporating amorphous silicon TFT (Thin Film Transistor). It is composed of a color TFT-LCD panel, driver ICs, control circuit, power supply circuit. Graphics and texts can be displayed on a 640×3×480 dots panel with 262,144 colors by supplying 18 bit data signals(6 bit/color), four timing signals, +3.3V DC supply voltage for TFT-LCD panel driving .

3. Mechanical Specifications

Parameter	Specifications	Unit
Display size	21.5(8.4") Diagonal	cm
Active area	170.88 (H) x 129.60(V)	mm
Pixel format	640(H) x 480(V)	pixel
	(1 pixel=R+G+B dots)	
Pixel pitch	0.267 (H) x0.270 (V)	mm
Pixel configuration	R,G,B vertical stripe	
Display mode	Normally white	
Outline dimensions *1	202.0(W) x 149.5(H) x 5.3(D)	mm(MAX)
Mass	175 ± 10	g
Surface treatment	Anti-glare and Anti-reflection coating 2H	

*1. Outline dimensions is shown in Fig.1

4. Input Terminals

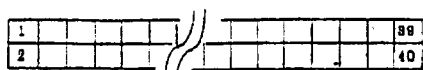

CN1 pin arrangement from module surface
(Transparent view)

The module-side connector : AXK5F40345 (Matsushita Electric Works, Ltd.)

The user-side connector : AXK6F40345 (" ")

Pin No.	Symbol	Function	Remark
1	GND		
2	CK	Clock signal for sampling each data signal	
3	GND		
4	Hsync	Horizontal synchronous signal	【Note1】
5	Vsync	Vertical synchronous signal	【Note1】
6	GND		
7	GND		
8	GND		
9	R0	RED data signal (LSB)	
10	R1	RED data signal	
11	R2	RED data signal	
12	GND		
13	R3	RED data signal	
14	R4	RED data signal	
15	R5	RED data signal (MSB)	
16	GND		
17	GND		
18	GND		
19	G0	GREEN data signal (LSB)	
20	G1	GREEN data signal	
21	G2	GREEN data signal	
22	GND		
23	G3	GREEN data signal	
24	G4	GREEN data signal	
25	G5	GREEN data signal (MSB)	
26	GND		
27	GND		
28	GND		
29	B0	BLUE data signal (LSB)	
30	B1	BLUE data signal	
31	B2	BLUE data signal	
32	GND		
33	B3	BLUE data signal	
34	B4	BLUE data signal	
35	B5	BLUE data signal (MSB)	
36	GND		
37	ENAB	Signal to settle the horizontal display position	【Note2】
38	NC	This should be electrically opened during operation.	
39	Vcc	+3.3V power supply	
40	Vcc	+3.3V power supply	

【Note1】 The polarity of both synchronous signals are negative.

【Note2】 The horizontal display start timing is settled in accordance with a rising of ENAB signal. In case ENAB is fixed "Low", the horizontal start timing is determined as described in 7-2. Don't keep ENAB "High" during operation.

※The shielding case is connected with GND in the module.

5. Absolute Maximum Ratings

Parameter	Symbol	Condition	Ratings	Unit	Remark
Input voltage	V_I	$T_a=25^\circ\text{C}$	$-0.3 \sim V_{cc}+0.3$	V	【Note1】
Vcc supply voltage	V_{cc}	$T_a=25^\circ\text{C}$	$0 \sim +6$	V	
Storage temperature	T_{stg}	—	$-25 \sim +60$	$^\circ\text{C}$	【Note2】
Operating temperature (panel surface)	T_{op}	—	$0 \sim +60$	$^\circ\text{C}$	

【Note1】 CK, R0~R5, G0~G5, B0~B5, Hsync, Vsync, ENAB

【Note2】 Humidity : 95%RH Max. ($T_a \leq 40^\circ\text{C}$)

Maximum wet-bulb temperature at 39°C or less ($T_a > 40^\circ\text{C}$)

No condensation.

6. Electrical Characteristics

$T_a=25^\circ\text{C}$

Parameter	Symbol	Min.	Typ.	Max.	Unit	Remark
Vcc Supply voltage	V_{cc}	+3.0	+3.3	+3.6	V	【Note1】
Vcc Current dissipation	I_{cc}	—	145	200	mA	【Note2】
Permissible input ripple voltage	V_{RF}	—	—	100	mVp-p	$V_{cc}=+3.3\text{V}$
Input voltage (Low)	V_{IL}	GND	—	$0.3V_{cc}$	V	【Note3】
Input voltage (High)	V_{IH}	$0.7V_{cc}$	—	V_{cc}	V	【Note3】
Input current (Low)	I_{IL}	—	—	10	μA	$V_I=\text{GND}$ 【Note3】
Input current (High)	I_{IH}	—	—	10	μA	$V_I=V_{cc}$ 【Note3】

【Note1】

On-off conditions for supply voltage

$0 < t_1 \leq 10\text{ms}$

$0 < t_2 \leq 10\text{ms}$

$0 < t_3 \leq 1\text{s}$

$t_4 \geq 1\text{s}$

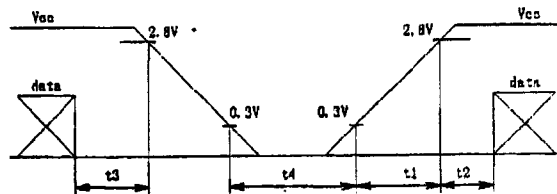

Vcc-dip conditions

1) $2.4\text{V} \leq V_{cc} < 3.0\text{V}$

$t_d \leq 10\text{ms}$

2) $V_{cc} < 2.4\text{V}$

Vcc-dip conditions should also follow the on-off conditions

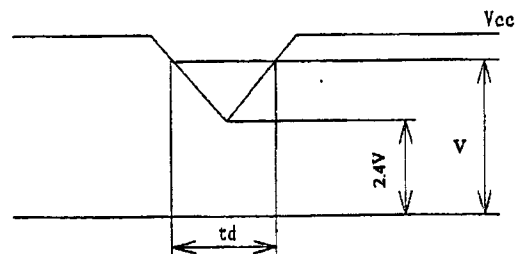

【Note2】 Typical current situation : 64-gray-bar pattern.

$V_{cc}=+3.3\text{V}$

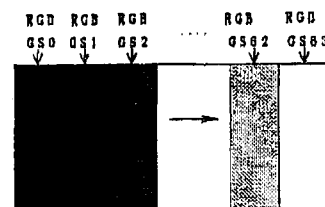

【Note3】 CK, R0~R5, G0~G5, B0~B5, Hsync, Vsync, ENAB

7. Timing characteristics of input signals

Timing diagrams of input signal are shown in Fig.2.

7-1. Timing characteristics

Parameter		Symbol	Min.	Typ.	Max.	Unit	Remark
Clock	Frequency	1/Tc	—	25.18	27.6	MHz	
	High time	Tch	5	—	—	ns	
	Low time	Tcl	10	—	—	ns	
	Duty ratio	Th/T	40	50	60	%	
Data	Setup time	Tds	5	—	—	ns	
	Hold time	Tdh	10	—	—	ns	
Horizontal Sync.signal	Cycle	TH	30.0	31.78	—	μ s	
			770	800	900	clock	
	Pulse width	THp	2	96	200	clock	
Vertical Sync.signal	Cycle	TV	515	525	560	line	
	Pulse width	TVp	2	—	34	line	
Horizontal display period		THd	640	640	640	clock	
Hsync-Clock phase difference		THc	10	—	Tc-10	ns	
Hsync-Vsync phase difference		TVh	1	—	TH-THp	clock	

【Note1】 In case of lower frequency, logical function is warranted, but the deterioration of display quality, flicker etc may be occurred .

7-2. Horizontal display position

① In case ENAB is active

The horizontal display position is determined by ENAB signal and the input data corresponding to the rising edge of ENAB signal is displayed at the left end of the active area .

Parameter		Symbol	Min.	Typ.	Max.	Unit	Remark
ENAB signal	Setup time	Tes	5	—	Tc-10	ns	
	Pulse width	Tep	2	640	640	clock	
Hsync-ENAB phase difference		The	44	—	TH-664	clock	

② In case ENAB is "Low"

The display starts from the data of C104(clock) as shown in Fig.2. Be careful that the module does not work When ENAB is fixed

7-3. Vertical display position

V-data start	TVs	34 line
V-data period	TVd	480 line

7-4 Input Data Signals and Display Position on the screen

Display position of input data (480 lines mode)
(H, V)

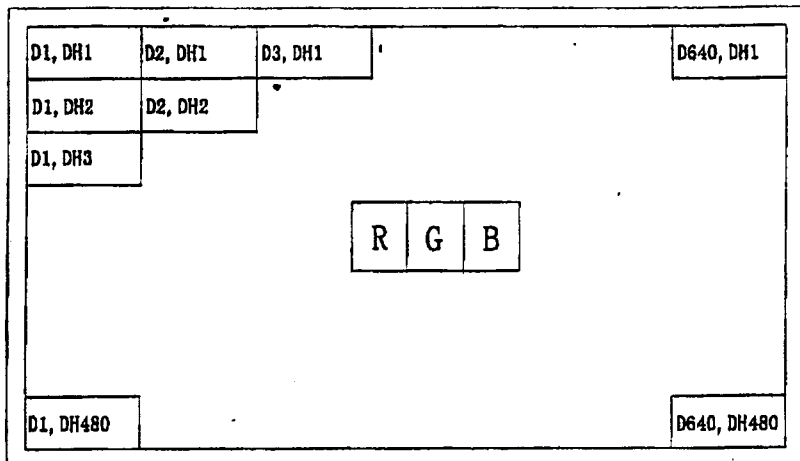
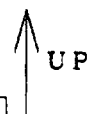

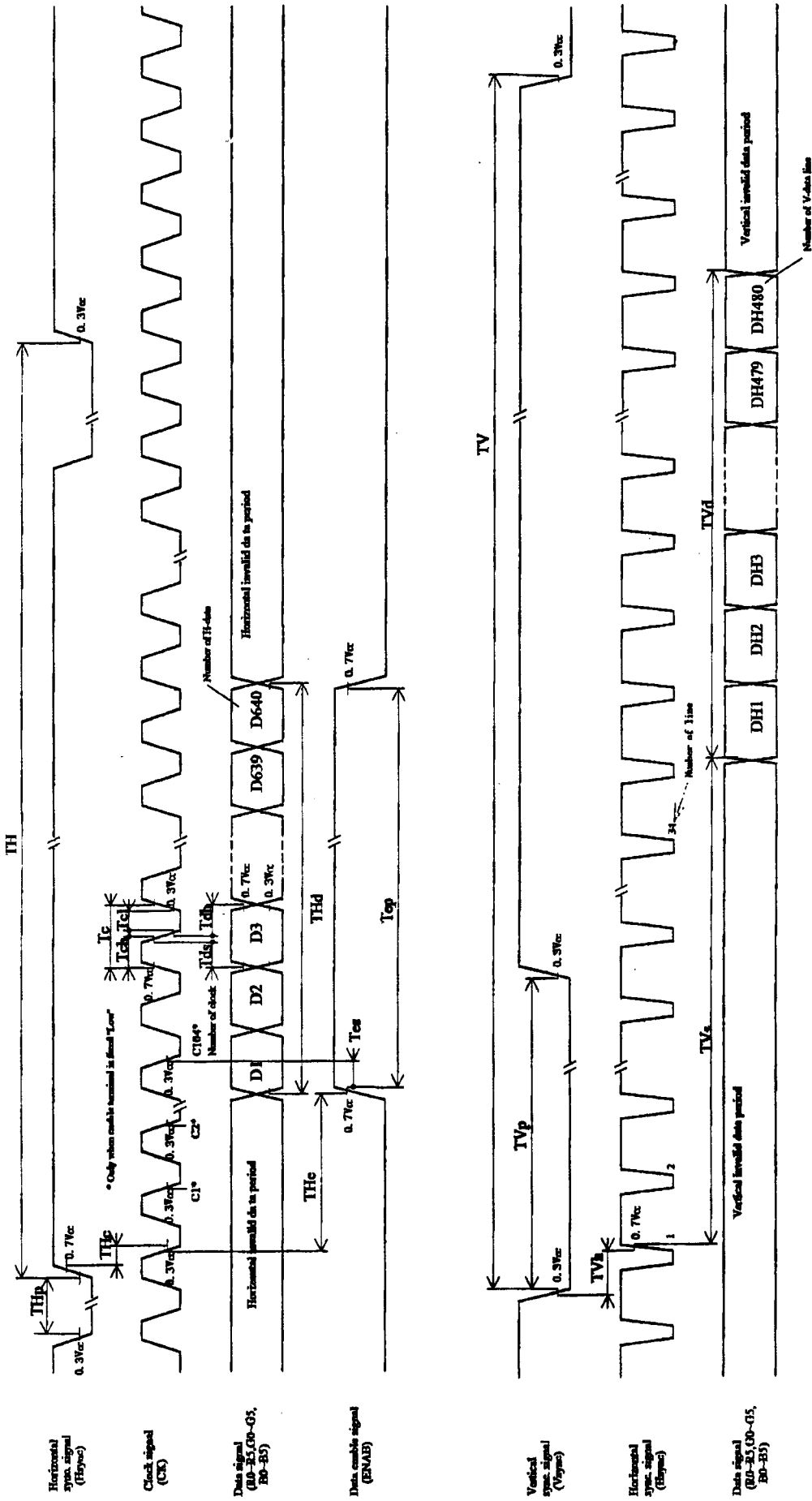

Fig. 2 Input signal waveforms

8. Input Signals, Basic Display Colors and Gray Scale of Each Color

	Colors & Gray scale	Data signal																		
		Gray Scale	R0	R1	R2	R3	R4	R5	G0	G1	G2	G3	G4	G5	B0	B1	B2	B3	B4	B5
Basic Color	Black	—	0	0	0	0	0	0	0	0	0	0	0	0	0	0	0	0	0	0
	Blue	—	0	0	0	0	0	0	0	0	0	0	0	0	1	1	1	1	1	1
	Green	—	0	0	0	0	0	0	1	1	1	1	1	1	0	0	0	0	0	0
	Cyan	—	0	0	0	0	0	0	1	1	1	1	1	1	1	1	1	1	1	1
	Red	—	1	1	1	1	1	1	0	0	0	0	0	0	0	0	0	0	0	0
	Magenta	—	1	1	1	1	1	1	0	0	0	0	0	0	1	1	1	1	1	1
	Yellow	—	1	1	1	1	1	1	1	1	1	1	1	1	0	0	0	0	0	0
	White	—	1	1	1	1	1	1	1	1	1	1	1	1	1	1	1	1	1	1
Gray Scale of Red	Black	GS0	0	0	0	0	0	0	0	0	0	0	0	0	0	0	0	0	0	0
	↑	GS1	1	0	0	0	0	0	0	0	0	0	0	0	0	0	0	0	0	0
	Darker	GS2	0	1	0	0	0	0	0	0	0	0	0	0	0	0	0	0	0	0
	↑	↓				↓					↓							↓		
	↓	↓				↓					↓							↓		
	Brighter	GS61	1	0	1	1	1	1	0	0	0	0	0	0	0	0	0	0	0	0
	↓	GS62	0	1	1	1	1	1	0	0	0	0	0	0	0	0	0	0	0	0
	Red	GS63	1	1	1	1	1	1	0	0	0	0	0	0	0	0	0	0	0	0
Gray Scale of Green	Black	GS0	0	0	0	0	0	0	0	0	0	0	0	0	0	0	0	0	0	0
	↑	GS1	0	0	0	0	0	0	1	0	0	0	0	0	0	0	0	0	0	0
	Darker	GS2	0	0	0	0	0	0	0	1	0	0	0	0	0	0	0	0	0	0
	↑	↓				↓					↓							↓		
	↓	↓				↓					↓							↓		
	Brighter	GS61	0	0	0	0	0	0	1	0	1	1	1	1	0	0	0	0	0	0
	↓	GS62	0	0	0	0	0	0	0	1	1	1	1	1	0	0	0	0	0	0
	Green	GS63	0	0	0	0	0	0	1	1	1	1	1	1	0	0	0	0	0	0
Gray Scale of Blue	Black	GS0	0	0	0	0	0	0	0	0	0	0	0	0	0	0	0	0	0	0
	↑	GS1	0	0	0	0	0	0	0	0	0	0	0	1	0	0	0	0	0	0
	Darker	GS2	0	0	0	0	0	0	0	0	0	0	0	0	1	0	0	0	0	0
	↑	↓				↓					↓							↓		
	↓	↓				↓					↓							↓		
	Brighter	GS61	0	0	0	0	0	0	0	0	0	0	0	0	1	0	1	1	1	1
	↓	GS62	0	0	0	0	0	0	0	0	0	0	0	0	0	1	1	1	1	1
	Blue	GS63	0	0	0	0	0	0	0	0	0	0	0	0	1	1	1	1	1	1

0 : Low level voltage, 1 : High level voltage

Each basic color can be displayed in 64 gray scales from 6 bit data signals. According to the combination of total 18 bit data signals, the 262,144-color display can be achieved on the screen.

9. Optical Characteristics

Ta=25°C

Parameter	Symbol	Condition	Min	Typ	Max	Unit	Remarks	
Viewing angle	$\theta_{21,22}$	$CR \geq 2$	40	50	—	° (degree)	【Note1】	
	$\theta_{11,12}$		40	50	—	° (degree)		
Contrast ratio	CR	$\theta = 0^\circ$	5	10	—		【Note2】	
Response time	Rise		τr	—	30	60	ms	【Note3】
	Fall		τd	—	50	100	ms	
White chromaticity	x			0.28	0.32	0.35		【Note4】
	y		0.33	0.36	0.41			
Reflection ratio	R		9	15	—	%	【Note5】	

The measuring method of the optical characteristics is shown by the following figure

The measuring system is LCD-5000 (with the unit reflecting diffusely) made by Otsuka electronics co.,Ltd.

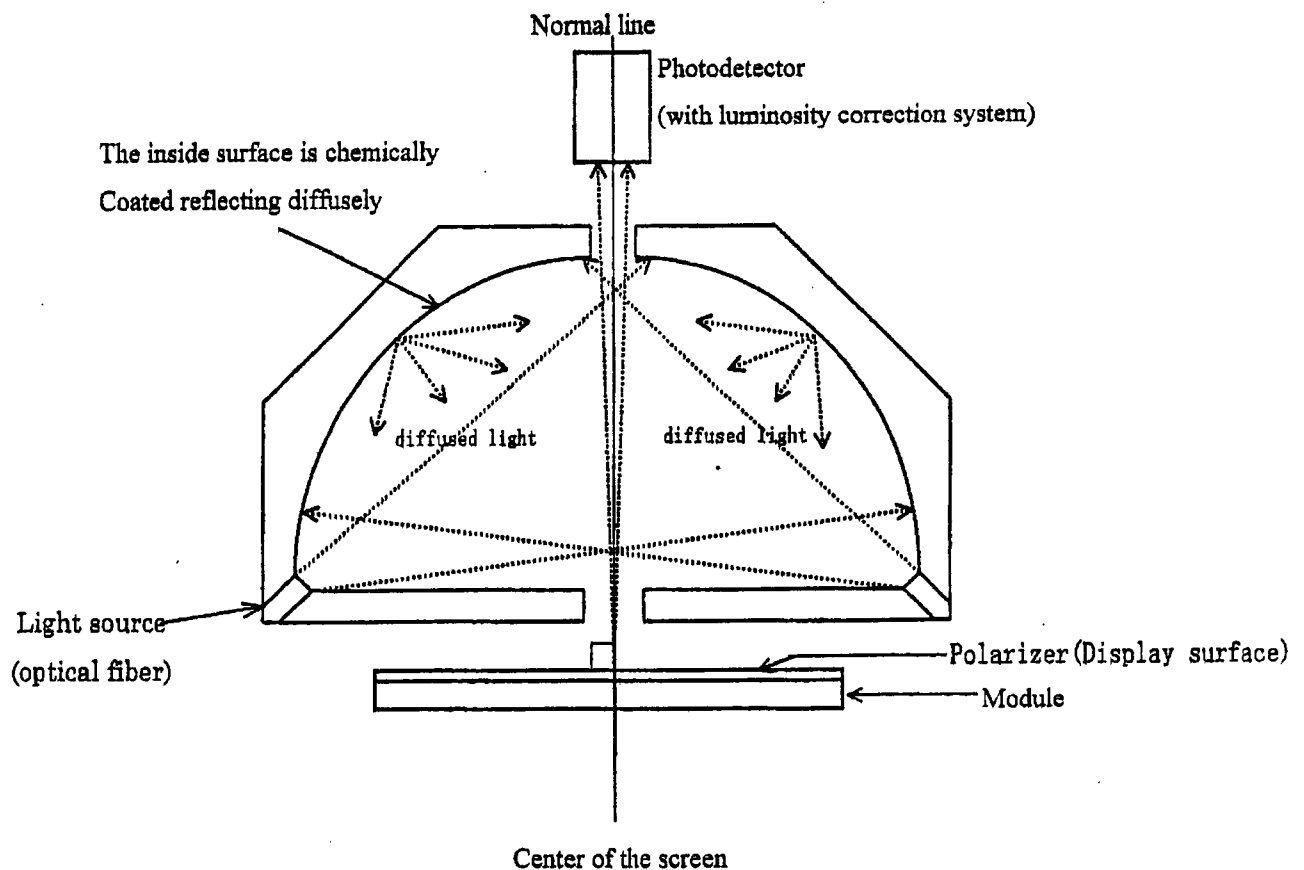
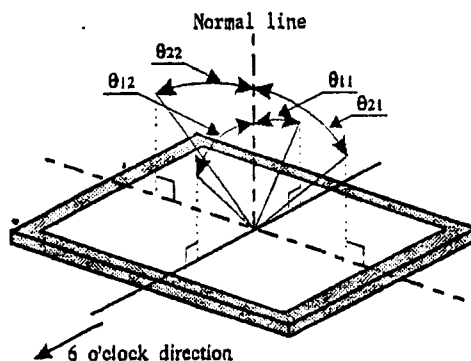

Fig. 3 Optical characteristics measurement method

【Note1】 Definitions of viewing angle range:



【Note2】 Definition of contrast ratio:

The contrast ratio is defined as follows:

$$\text{Contrast ratio(CR)} = \frac{\text{Photodetector output with all pixels white(GS63)}}{\text{Photodetector output with all pixels black(GS0)}}$$

【Note3】 Definition of response time:

The response time is defined as the following figure and shall be measured by switching the input signal for "black" and "white".

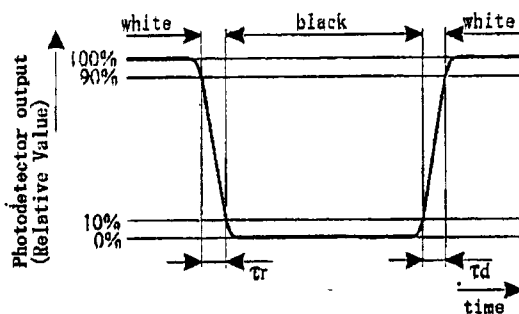

【Note4】 It is assumed that chromaticity of the light source is (x=0.313,y=0.329).

【Note5】 Definition of reflection ratio

$$\text{Reflection ratio} = \frac{\text{Light detected level of the reflection by the LCD module}}{\text{Light detected level of the reflection by the standard white board}} \times 100$$

10. Handling Precautions

- a) Be sure to turn off the power supply when inserting or disconnecting the cable .
- b) Be sure to design the cabinet so that the module can be installed without any extra stress such as warp or twist .
- c) Since the front polarizer is easily damaged, pay attention not to scratch it .
- d) Since long contact with water may cause discoloration or spots, wipe off water drop immediately .
- e) When the panel surface is soiled, wipe it with absorbent cotton or other soft cloth .
- f) Since the panel is made of glass, it may break or crack if dropped or bumped on hard surface. Handle with care .
- g) Since CMOS LSI is used in this module, take care of static electricity and take the human earth into consideration when handling .
- h) Laminated film is attached to the module surface to prevent it from being scratched. Peel the film off slowly just before the use with strict attention to electrostatic charges. Ionized air shall be blown over during action. Blow off 'dust' on the polarizer by using an ionized nitrogen gun, etc.
- i) Connect GND to 4 places of mounting holes to minimize against EMI and external noise.
- j) Observe all other precautionary requirements in handling general electronic components .
- k) When some pressure is added onto the module from rear side constantly , it causes display non-uniformity issue , functional defect , etc . So , please avoid such design .
- l) The force to the interface connector occurred by drop , shock or wiring of FPC, when mounting the user-side connector on a FPC board, may make the connector disconnected . Please secure the connection by any means.

11. Packing form

- a) Piling number of cartons : maximum 9 cartons
- b) Packing quantity in one carton : maximum 20 modules
- c) Carton size : 381mm (w)×377mm (D)×269mm(H)
- d) Total mass of one carton filled with full modules : 4800g
- e) Packing form is shown in Fig.4

12. Reliability test items

No.	Test item	Conditions
1	High temperature storage test	Ta=60°C 240h
2	Low temperature storage test	Ta=-25°C 240h
3	High temperature & high humidity operation test	Ta=40°C ; 95%RH 240h (No condensation)
4	High temperature operation test	Ta=50°C 240h (The panel temp. must be less than 60°C)
5	Low temperature operation test	Ta=0°C 240h
6	Vibration test (non- operating)	Frequency : 5~500Hz/Gravity:9.8m/s ² Sweep time : 13.3 minutes Test period : 3 hours (1 hour for each direction of X,Y,Z)
7	Shock test (non- operating)	Max. gravity : 490m/s ² Pulse width : 11ms, sine wave Direction : ±X,±Y,±Z once for each direction.

【Result Evaluation Criteria】

Under the display quality test conditions with normal operation state, these shall be no change which may affect practical display function .

13. Others

1) Lot No. and indication Label:

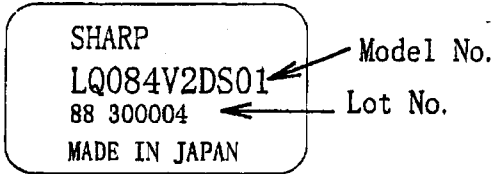

How to express Lot No.

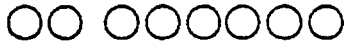

A production year (the last figures of the Christian Era)

A production month (1~9,X,Y,Z)

Serial No.

2) Adjusting volume have been set optimally before shipment, so do not change any adjusted value .

If adjusted value is changed, the specification may not be satisfied .

3) Disassembling the module can cause permanent damage and should be strictly avoided .

4) Please be careful since image retention may occur when a fixed pattern is displayed for a long time.

5)When any question or issue occurs , it shall be solved by mutual discussion .

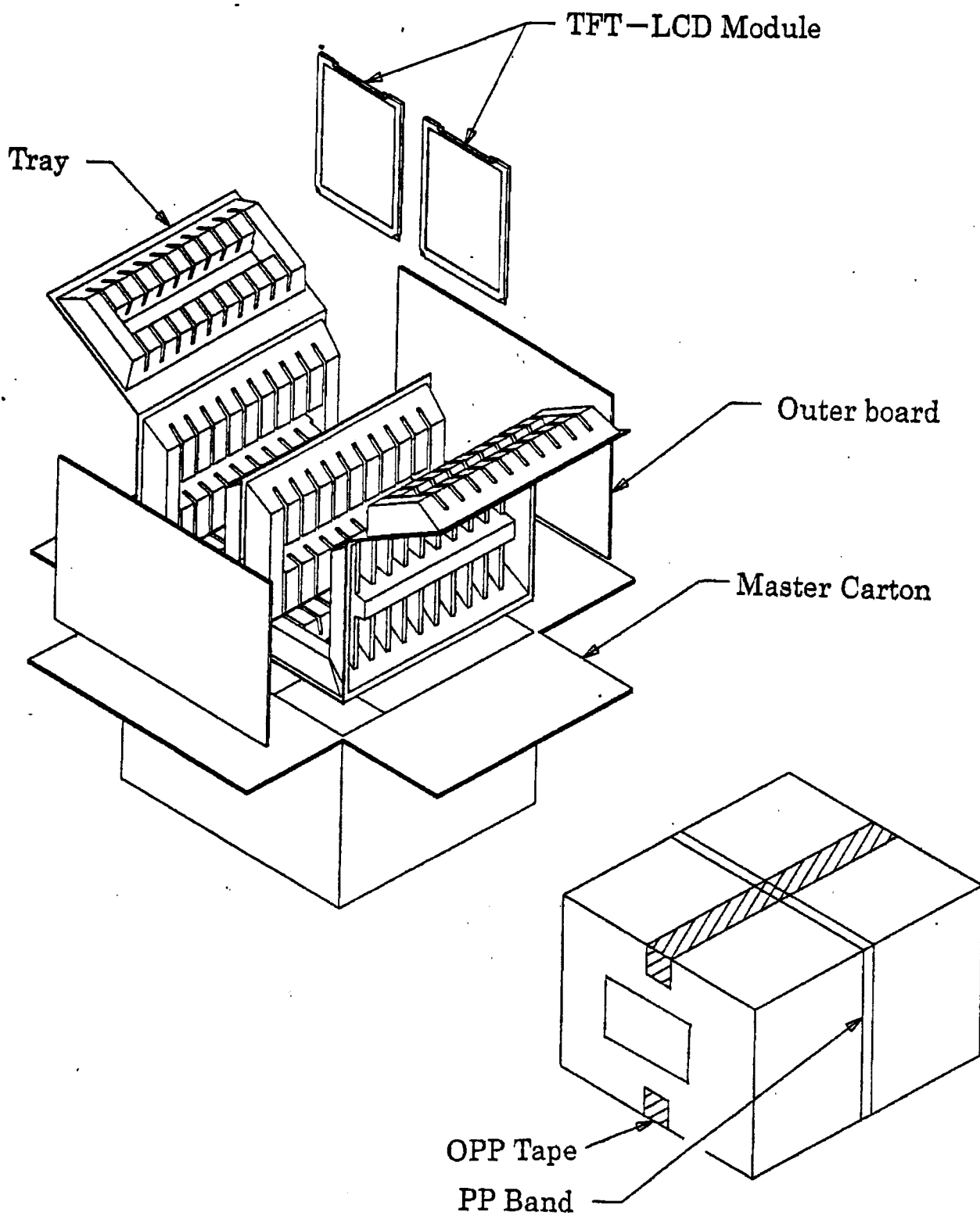
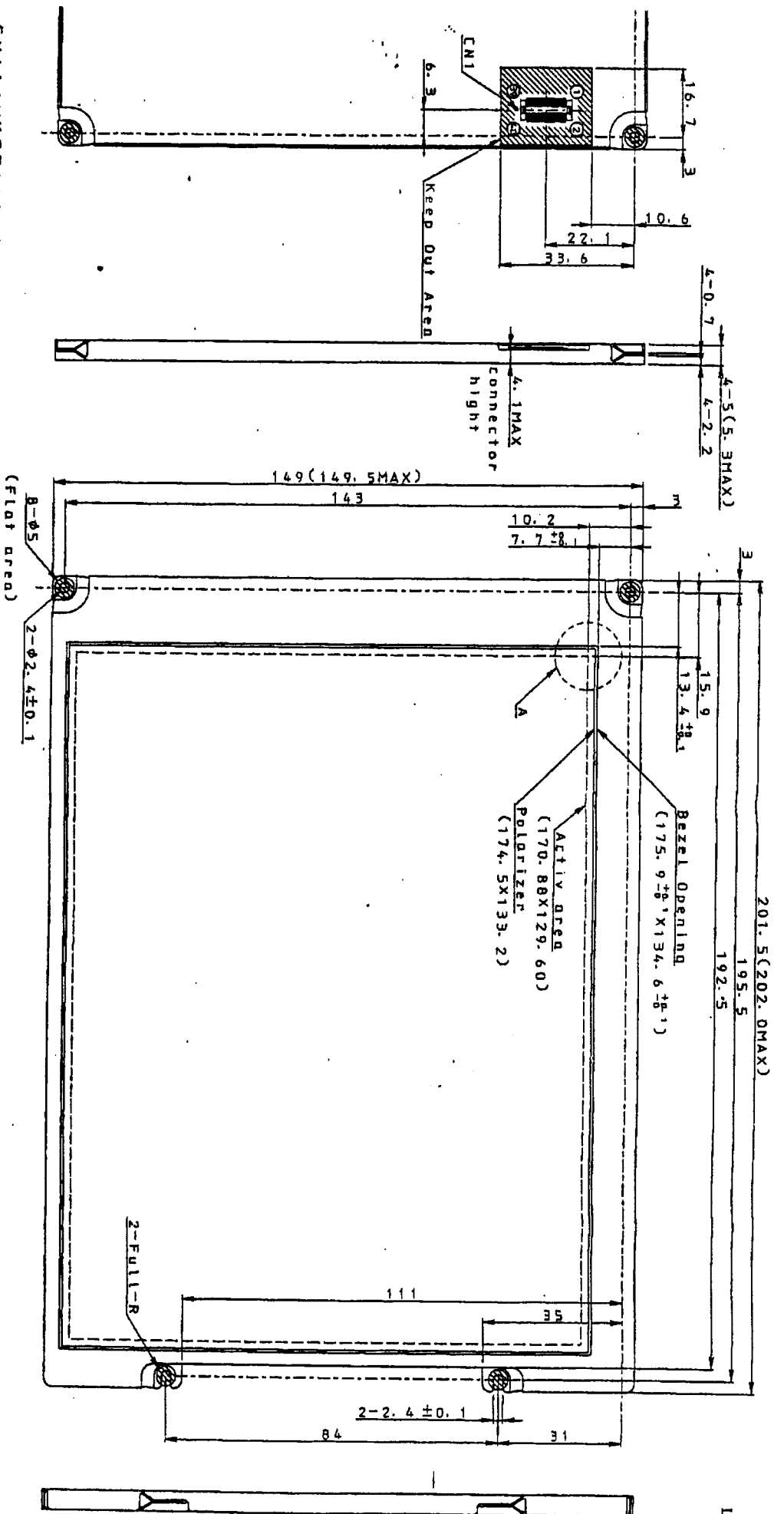
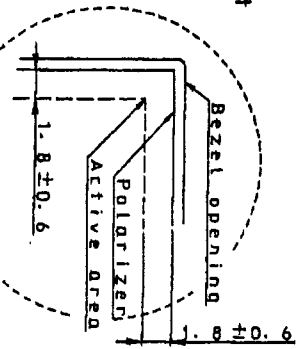

Fig4. Packing Form



CN1: AXK5F40345
 (Matsushita Electric Works. LTD)
 3.6mm Max. component height
 from Module surface



UNSPECIFIED TOLERANCE TO BE ± 0.5

Detail A (S=3/1)

Fig. 1. Outline dimensions