

LS1-THR1-01

Applications

Optical indicators
 Coupling into light guides
 Back lights (LCD, switches, keys, displays, illuminated advertising, general lighting)
 Interior automotive lighting (dashboard backlighting)
 Marker lights (steps, exit ways)
 Signal and symbol luminaire
 Automotive applications

Maximum Ratings (Ta=25°C)

Characteristic	Symbol	Max.	Unit
Forward Current	I _F	50	mA
Reverse Voltage	V _R	5	V
Power Dissipation	P _D	150.00	mW
Operating Temperature	T _{opr}	-40 ~ +100	°C
Storage Temperature	T _{stg}	-40 ~ +100	°C
Soldering Temperature	T _{sol}	250	°C
Soldering Time	-	for 3 sec. max	-

Opto-Electrical Characteristics (Ta=25°C)

Characteristic	Symbol	Test Condition	Min	Typ	Max	Unit
Forward Voltage	V _F	I _F =20mA	-	2.10	2.60	V
Reverse Current	I _R	V _R =5V	-	-	10	μA
Luminous Intensity	I _v	I _F =20mA	280.00	400.00	-	mcd
Viewing Angle	2θ ^{1/2}	-	-	120°	-	deg.
Peak Wavelength	λ _p	I _F =20mA	-	639	-	nm
Dominant Wavelength	λ _d	I _F =20mA	-	628	-	nm
Spectral Line Half Width	Δλ	I _F =20mA	-	23	-	nm

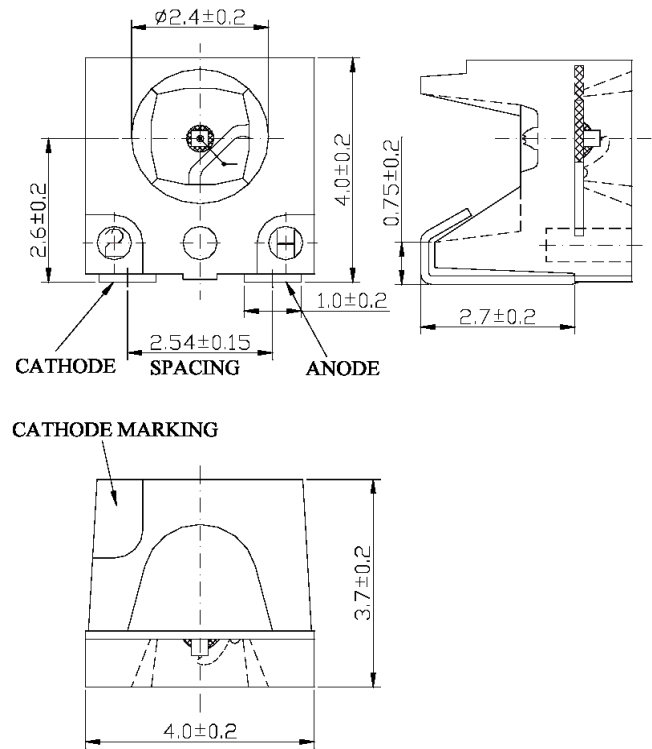

Dimensions are specified as follows: mm.

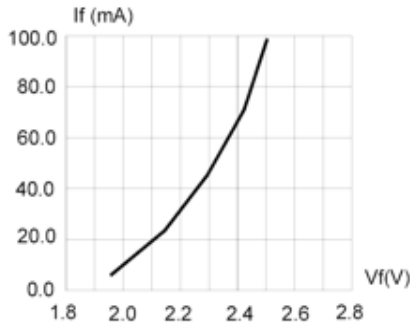

FIG.1 FORWARD CURRENT VS. FORWARD VOLTAGE.

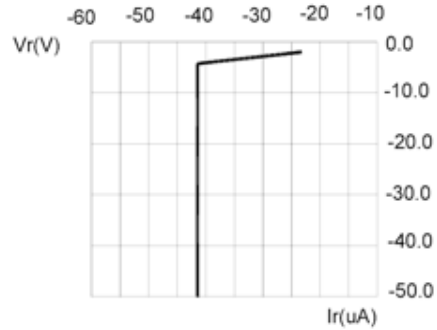

FIG.2 REVERSE CURRENT VS. REVERSE VOLTAGE.

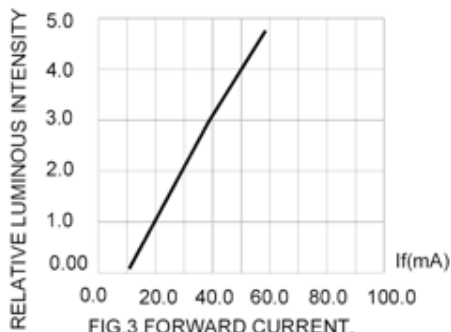

FIG.3 FORWARD CURRENT.

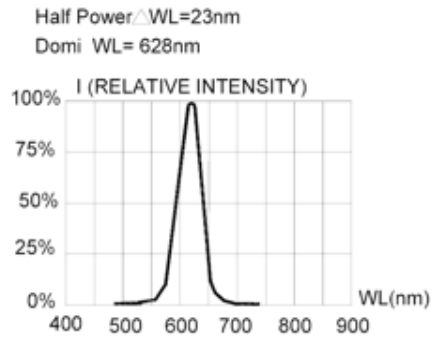

FIG.4 RELATIVE INTENSITY VS. WAVE LENGTH.

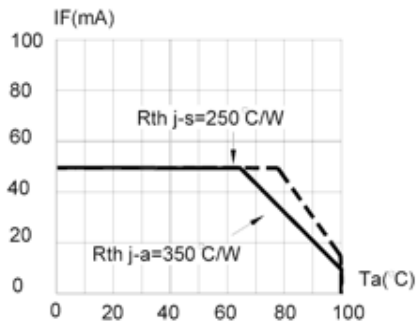

FIG.5 MAXIMUM FORWARD DC CURRENT VS TEMPERATURE. DERATING BASED ON $T_{jmax}=110^{\circ}C$

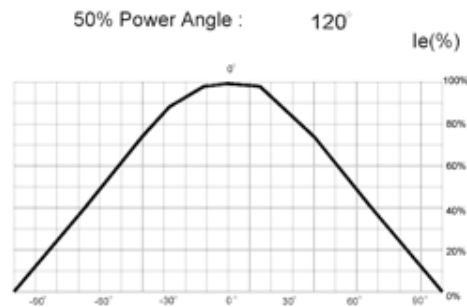

FIG.6 SPATIAL DISTRIBUTION.