

DESCRIPTION

The LXMG1621 Direct Drive™ CCFL (Cold Cathode Fluorescent Lamp) Inverter Modules are specifically designed for driving two lamp LCD backlight displays.

Similar to the LXMG1620, the LXMG1621 excels in applications where critical parameters include very wide range dimmability, high efficiency, and reliable fail-safe design in a small form factor. These 12 volt modules are specifically designed with desktop and industrial applications in mind.

Unlike the LXMG1620 or any traditional dimming CCFL inverters, the LXMG1621 provides the designer a vastly superior display brightness range. 100:1+ brightness range is achievable with a standard LCD display (see Product Highlight). Our wide range dimming provides exceptional display readability at less than 1% of full brightness, allowing both power savings and low ambient light operating capability (i.e. "night readable").

Digital dimming provides flicker-free brightness control in any wide-range dimming application.

IMPORTANT: For the most current data, consult MICROSEMI's website: <http://www.microsemi.com>
Protected By U.S. Patents: 5,923,129; 5,930,121; Patents Pending

Incorporation of a video synchronization feature allows wide ratio dimming without the display disturbances and interference seen with competitive products.

The modules are equipped with a dimming input that permits brightness control from an external potentiometer or DC voltage source. The resultant "burst drive" that energizes the lamp was designed specifically to ensure that no premature lamp degradation occurs (see the "How RangeMAX works" section).

The module design is based on a new Direct Drive topology, which provides a number of cost and performance advantages.

Microsemi's multiple lamp inverters include a built in connector array for the most common LCD lamp configurations.

Other benefits of this new topology are fixed-frequency operation and secondary-side strike-voltage regulation.

The LXMG1621 is fully customizable (electronically and mechanically) to specific customer requirements.

KEY FEATURES

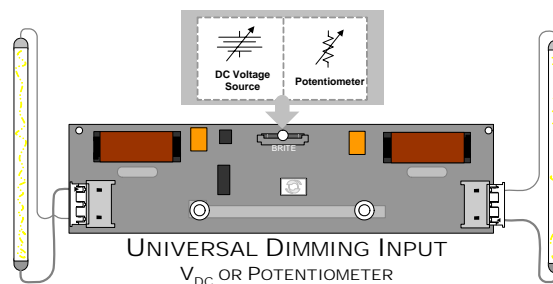
- RangeMAX Wide Range Dimming
- 8V to 16V Input Voltage Range
- Small Form Factor
- Easy To Use Brightness Control
- MicroAmp SLEEP Mode
- Output Short-Circuit Protection And Automatic Strike-Voltage Regulation
- Fixed Frequency Operation
- Universal Connector Configuration
- RoHS Compliant
- UL 60950 E17590

APPLICATIONS

- Hi-Brite Displays
- Desktop Displays
- Low Ambient Light Conditions (i.e. Aircraft Cabins, Automobile)
- Industrial Applications

BENEFITS

- High Efficiency Reduces Heating Problems
- Smooth, Flicker Free 0-100% Full-Range Brightness Control Gives Your Product A High Quality Image
- Output Open Circuit Voltage Regulation Minimizes Corona Discharge For Long Life And High Reliability
- Power Efficient, "Low Brightness" Capability Allows For Advanced Power Management

PRODUCT HIGHLIGHT

MODULE ORDER INFO

PART NUMBER	LAMP CURRENT	LAMP RUN VOLTAGE (RMS)
LXMG1621-01	7mA	500-750
LXMG1621-02	6mA	350-550
LXMG1621-03	6.5mA	350-550
LXMG1621-04	5mA	470-640

ABSOLUTE MAXIMUM RATINGS (NOTE 1)

Input Supply Voltage (V_{IN}).....	-0.3V to 18V
Output Voltage, no load.....	Internally Limited to 1800V _{RMS}
Output Current.....	10mA _{RMS} (Internally Limited)
Output Power (per lamp).....	6W
Input Signal Voltage (BRITE Input).....	-0.3V to 6.5V
Input Signal Voltage (SLEEP, V_{SYNC}).....	-0.3V to V_{IN}
Ambient Operating Temperature, zero airflow.....	0°C to 70°C
Storage Temperature Range.....	-40°C to 85°C

Note 1: Exceeding these ratings could cause damage to the device. All voltages are with respect to Ground. Currents are positive into, negative out of specified terminal

RECOMMENDED OPERATING CONDITIONS

This module has been designed to operate over a wide range of input and output conditions. However, best efficiency and performance will be obtained if the module is operated under the condition listed in the 'R.C.' Column. Min. and Max. columns indicate values beyond which the inverter, although operational, will not function optimally.

Parameter	Symbol	Recommended Operating Conditions			Units
		Min	R.C.	Max	
Input Supply Voltage Range (Functional)	V_{IN}	8	12	16	V
Input Supply Voltage (Fully Regulated Lamp Current)		10.2	12	13.8	V
Output Power (Per Lamp) LXMG1621-01 LXMG1621-02 / 03 LXMG1621-04	P_O		4	5	W
			2.5	3	W
			2.75	3.5	W
Brightness Control Input Voltage Range	V_{BRT_ADJ}	0.0		2.5	V
Lamp Operating Voltage LXMG1621-01 LXMG1621-02 / 03 LXMG1621-04	V_{LAMP}		500	625	V _{RMS}
			350	425	V _{RMS}
			470	550	V _{RMS}
Lamp Current (Full Brightness – Per Lamp) LXMG1621-01 LXMG1621-02 LXMG1621-03 LXMG1621-04	I_{OLAMP}			7.0	mA _{RMS}
				6.0	mA _{RMS}
				6.5	mA _{RMS}
				5.0	MA _{RMS}
Operating Ambient Temperature Range	T_A	0		70	°C

ELECTRICAL CHARACTERISTICS

Unless otherwise specified, these specifications apply over the recommended operating conditions and 25°C ambient temperature for the LXMG1621-xx.

Parameter	Symbol	Test Conditions	LXMG1621-xx			Units
			Min	Typ	Max	
OUTPUT PIN CHARACTERISTICS						
Full Brightness Current LXMG1621-01 LXMG1621-02 LXMG1621-03 LXMG1621-04	$I_{L(MAX)}$	$V_{BRT_ADJ} = 2.5V_{DC}$, SLEEP = HIGH, Burst Duty = 100%, $V_{IN} = 12V_{DC}$	6.3	7.0	7.7	mA _{RMS}
		$V_{BRT_ADJ} = 2.5V_{DC}$, SLEEP = HIGH, Burst Duty = 100%, $V_{IN} = 12V_{DC}$	5.5	6.0	6.5	mA _{RMS}
		$V_{BRT_ADJ} = 2.5V_{DC}$, SLEEP = HIGH, Burst Duty = 100%, $V_{IN} = 12V_{DC}$	5.7	6.5	7.1	mA _{RMS}
		$V_{BRT_ADJ} = 2.5V_{DC}$, SLEEP = HIGH, Burst Duty = 100%, $V_{IN} = 12V_{DC}$	4.5	5.0	5.5	mA _{RMS}
Minimum Lamp Current (Per Lamp) (Notes 2 & 3)	$I_{L(MIN)}$	$V_{BRT_ADJ} = 0V_{DC}$, SLEEP = HIGH, Burst Duty = 2%, $V_{IN} = 9V_{DC}$		0.14		mA _{RMS}
		$V_{BRT_ADJ} = -50mV_{DC}$, SLEEP = HIGH, Burst Duty = 0.5%, $V_{IN} = 9V_{DC}$		0.035		mA _{RMS}
Lamp Start Voltage	V_{LS}	0°C < T_A < 40°C, $V_{IN} > 10.8V_{DC}$	1500		1800	V _{RMS}
Operating Frequency	f_o	$V_{BRT_ADJ} = 2.5V_{DC}$, SLEEP = HIGH, $V_{IN} = 12V_{DC}$	52	57	62	kHz

ELECTRICAL CHARACTERISTICS (CONTINUED)

Unless otherwise specified, these specifications apply over the recommended operating conditions and 25°C ambient temperature for the LXMG1621-xx.

Parameter	Symbol	Test Conditions	LXMG1621-xx			Units
			Min	Typ	Max	
BRITE INPUT						
Input Current	I_{BRT}	$V_{BRT_ADJ} = 0V$	-6	-8	-10	μA_{DC}
Input Voltage For Max. Lamp Current	V_C	$I_{O(LAMP)} = 100\%$ Duty Cycle		2.5	2.6	V_{DC}
Input Voltage For Min. Lamp Current (Note 3)	V_C	$I_{O(LAMP)} = 2\%$ Duty Cycle		0	0	V_{DC}
		$I_{O(LAMP)} = 0.5\%$ Duty Cycle		-50		mV_{DC}
SLEEP INPUT						
RUN Mode	$V_{SLEEP(HI)}$		2.2		V_{IN}	V_{DC}
SLEEP Mode	$V_{SLEEP(LO)}$		-0.3		0.8	V_{DC}
Input Current	I_{SLEEP}	$\overline{SLEEP} = 5.0V$	70	75	100	μA_{DC}
V_{SYNC} CHARACTERISTICS						
Logic High Level	$V_{SYNC(HI)}$		4.0		6.5	V_{DC}
Logic Low Level	$V_{SYNC(LO)}$		-0.3		1.0	V_{DC}
Input Impedance	Z_{IN}		60	66	75	$K\Omega$
Pulse Width (Note 4)	t_{PW}		25		250	μs
Input Frequency	f_{SYNC}		49		150	Hz
POWER CHARACTERISTICS						
Sleep Current	$I_{IN(MIN)}$	$V_{IN} = 12V_{DC}, \overline{SLEEP} \leq 0.8V$		5	50	μA_{DC}

Note 2: Minimum lamp current required to maintain even light output may vary with display panel.

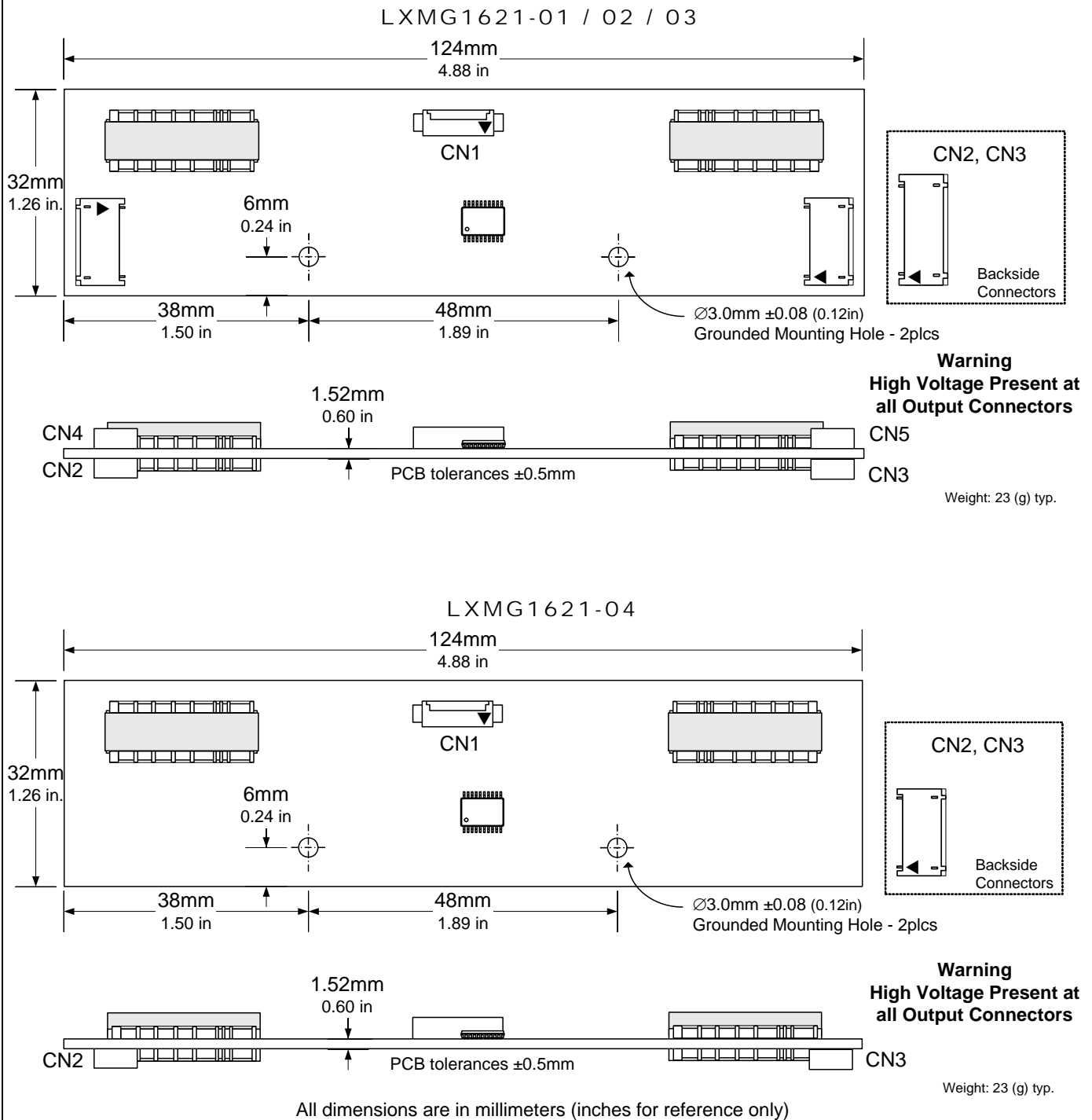
Note 3: See 200:1 Dimming Application section for details.

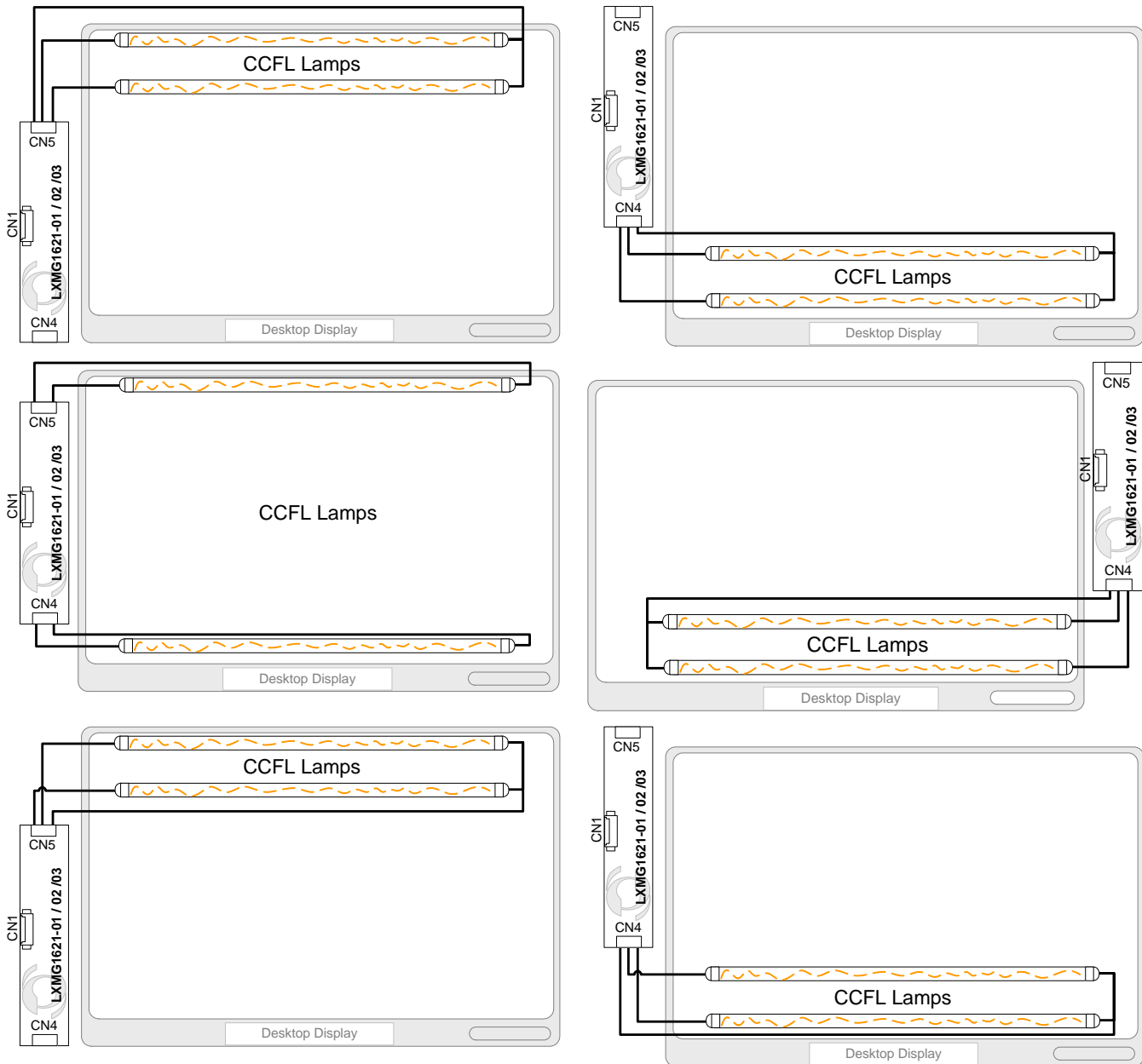
 Note 4: The module will be functional with pulse widths much larger than 250 μs .

FUNCTIONAL PIN DESCRIPTION

Conn.	Pin	Description
CN1		
CN1-1	V_{IN}	Input Power Supply ($8V \leq V_{IN} \leq 16V$)
CN1-2		
CN1-3	GND	Power Supply Return
CN1-4		
CN1-5	\overline{SLEEP}	ON / OFF Control. ($2.2V < \overline{SLEEP} < V_{IN} = ON, -0.3V < \overline{SLEEP} < 0.8V = OFF$)
CN1-6	BRITE	Brightness Control ($-0.3V$ to $2.5V_{DC}$). $2.5V_{DC}$ gives maximum lamp current.
CN1-7, 8	VSYNC	Vertical synchronization input $49Hz < f_{SYNC} < 150Hz$

CN2 thru CN5: Refer to Connection Schematic Section

PHYSICAL DIMENSIONS


TYPICAL CONNECTION CONFIGURATIONS


* Connectors CN2 and CN3 are on the bottom side of the inverter. View shown is looking through the board

Figure 1 – Connectivity Configuration Examples

These examples illustrate six typical LCD wiring configurations that are accommodated by Microsemi's unique connector array. Microsemi inverters have multiple lamp connector styles that are common to the industry, which are duplicated at both ends of the module. This permits over 14 variations of module mounting and interconnectivity configuration.

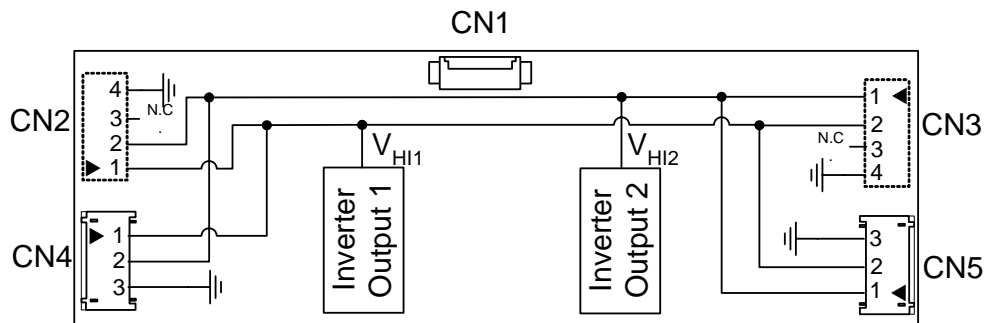
CONNECTION SCHEMATIC


Figure 2a – LXMG1621-01 / 02 / 03 Connection Schematic

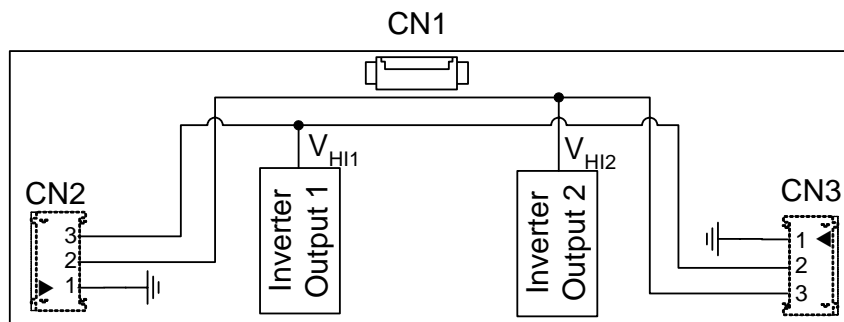


Figure 2b – LXMG1621-04 Connection Schematic

Connectors:	Mates With
CN1 Molex 53261-0871	Pins: 50079-8100*, Housing: 51021-0800 *Loose(-8000, Chain) Recommended #26 AwG wiring
Connection for LXMG1621-01 / 02 / 03	
CN2, CN3 JST SM04(4.0)B-BHS-1-TB(LF)(SN) or Yeon Ho 20015WR-07A00	JST BHR-04VS-1
CN4, CN5 JST SM03(4.0)B-BHS-1-TB(LF)(SN) or Yeon Ho 20015WR-05A01	JST BHR-03VS-1
Connection for LXMG1621-04	
CN2, CN3 JST SM03(4.0)B-BHS-1-TB(LF)(SN) or Yeon Ho 20015WR-05A01	JST BHR-03VS-1

Connection Rules

1. Always install two (2) lamps. Operating with only one lamp may overdrive lamp current at maximum brightness settings.
2. Verify lamp wiring before connecting lamps to the inverter module. Connecting both lamps to one of the two inverter output circuits will result in reduced brightness. The LXMG1621-01 / 02 / 03 module connectors are wired per industry standard. The lamp hot wires (high voltage wires) are always on pin 1 and / or 2, and the cold wire (low voltage wire) is always on pin 3 or 4.
3. The LXMG1621-04 uses the reverse pinout found in some panels. The lamp hot wires (high voltage wires) are on pins 2 and 3 and the cold (low voltage wire) is on pin 1.

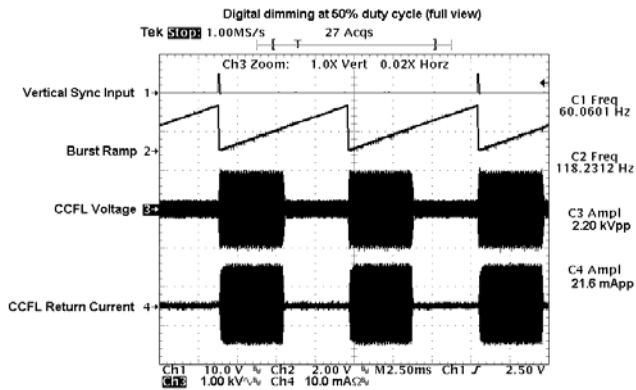
HOW THE RANGEMAX WORKS
LAMP VOLTAGE & LAMP CURRENT – BURST MODE OPERATION


Figure 3 – 50% Burst Duty Cycle

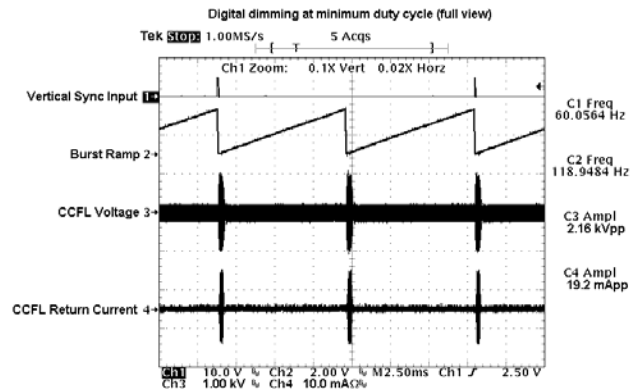


Figure 4 – 2% Burst Duty Cycle

Rather than using the traditional dimming technique of varying lamp current magnitude to adjust light output, RangeMAX inverters use a fixed lamp current value with a duty cycle control method.

The lamp current burst width can be modulated from 100% (continuous lamp current) down to a 2% duty cycle, allowing the lamp to be dimmed to less than 1% of its full brightness.

As can be seen in Trace 3 of Figure 5 photo at right, careful design consideration was given to controlling lamp start voltage to softly start current flow. This eliminates current overshoot that can result in premature cathode wear and reduce lamp life.

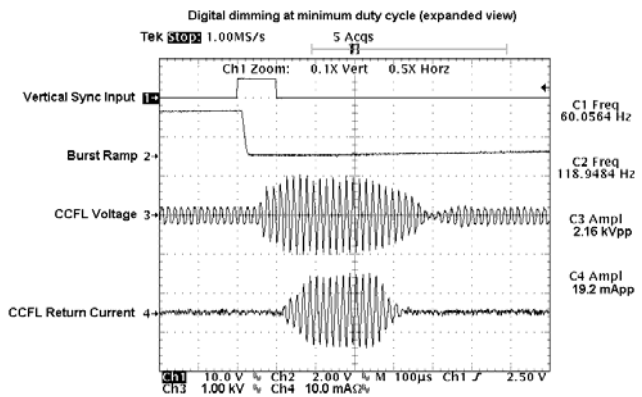


Figure 5 – 2% Burst Duty Cycle (Expanded Time Base)

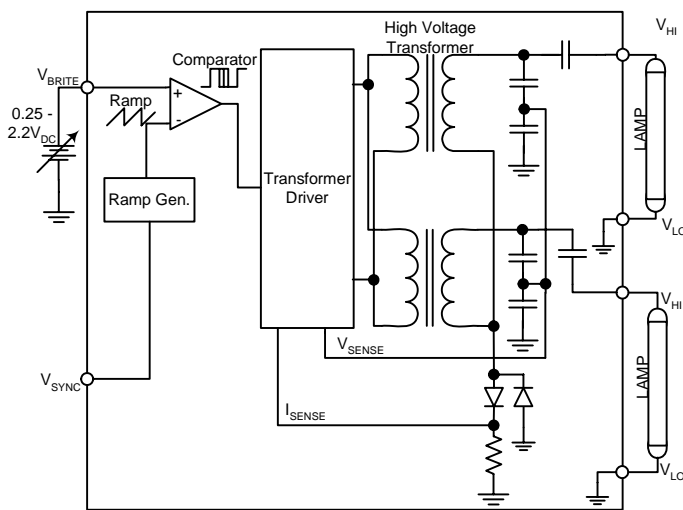


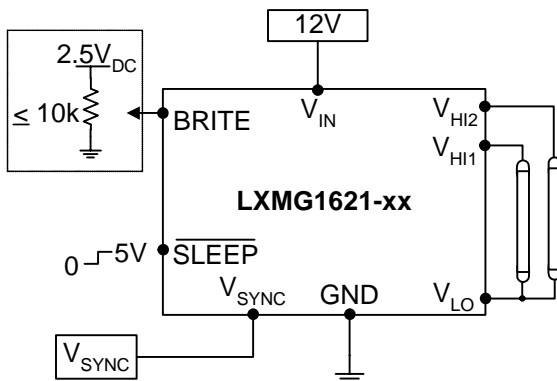
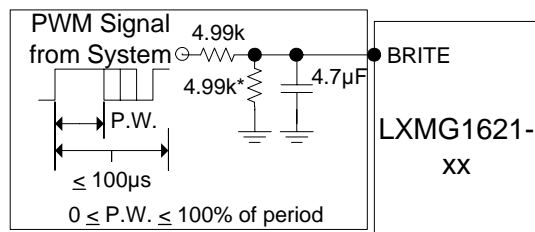
Figure 6 – RangeMAX Simplified Block Diagram

HIGHLIGHTS

- Integrated brightness control circuit includes a DC voltage to pulse width converter that minimizes system design work and system noise susceptibility. This provides a familiar and convenient interface while reducing the potential for externally induced noise, which can cause lamp flicker.
- An on-board oscillator operates the inverter BURST rate about 95Hz, well beyond standard 50/60Hz video refresh rates where the eye can perceive pulsing light.
- RangeMAX inverter modules are designed to operate with the burst frequency synchronized to the video frame rate. This provides operation with no visible display disturbances caused by beat frequencies between the lamps and video frame rates.

HOW THE RANGEMAX WORKS (CONTINUED)
HIGHLIGHTS (CONTINUED)

- In applications with no access to a vertical sync, the inverter burst frequency can be allowed to “free run” at 95Hz. In this non-synchronous mode, minor display disturbances may be found under certain video conditions. This performance is acceptable for many applications, but synchronization must be used when no disturbance can be tolerated.
- Separate feedback loops for lamp current and open circuit voltage regulation insure reliable strike under all operating conditions, automatic over-voltage prevention with broken or failed lamps, and accurate lamp current regulation.

TYPICAL APPLICATION

Figure 7- Brightness Control


* use 4.99k for 5V PWM amplitude, 15k for 3.3V PWM amplitude, and omit for 2.5V PWM amplitude.

Figure 8 - PWM Brightness Control

- The brightness control may be a simple 10k potentiometer or a voltage output DAC. A PWM signal from a microcontroller may also be used with a suitable filter such as shown in figure 8.
- If synchronization to the video frame rate is desired, connect the vertical sync pulse from the system video controller to the appropriate V_{SYNC} input. If no video synchronization is desired, connect V_{SYNC} to ground.
- If you need to turn the inverter ON/OFF remotely, connect a 3V or 5V logic signal to the $SLEEP$ input. If remote ON/OFF is not needed, connect the $SLEEP$ input to V_{IN} or any other voltage greater than $2.2V_{DC}$.
- Connect V_{HI} to high voltage wire from the lamp. Connect V_{LO} to the low voltage wire (wire with thinner insulation). If both lamp wires have heavy high voltage insulation, connect the longest wire to V_{LO} . V_{LO} is connected directly to ground (GND pin) on the inverter PCB. Always insure a good lamp return by using a wire. Do not rely on a chassis ground connection.

RangeMAX INVERTERS

Also available in single lamp inverters are the LXMG1612-12-xx or LXMG1615-xx-xx, as well as the 12V dual lamp LXMG1623-xx-xx, LXMG1622-12-xx, and the Quad output LXMG1643-12-6x versions for multiple lamp applications.

WIDER DIMMING APPLICATION

The following application defines techniques capable of delivering dimming ranges in the 250:1 range. As is widely understood, these techniques will provide general capabilities and actual system performance will vary with panel design, CCFTs, ambient temperature and a number of other variables outside the control of the inverter. These methods can be used in conjunction with other techniques such as lamp heating and matching.

Wide ratio (250:1) dimming can be accomplished using the Microsemi inverter in two ways:

1. By varying the input voltage on the brightness pin as indicated in Figure 9. Caution must be exercised when applying negative voltage to the brightness control input. Applying more than -300mV to any inverter input will cause inverter malfunction (see Absolute Maximum Ratings).

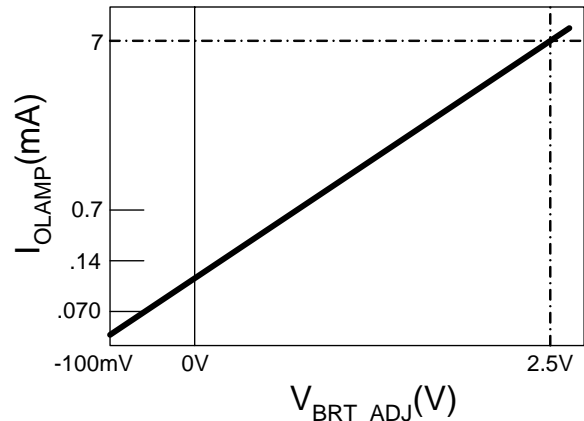


Figure 9 – Average Lamp Current vs. V_{BRITE} Voltage (per Lamp)

2. By making a resistor value change on the module. Remove R61 for maximum dimming range or increase R61 value to desired minimum dim range setting (see figure 10). Care should be exercised since at a low enough dim setting the inverter will be unable to detect that the lamp has started and will initiate lamp strike (kickoff) voltage. This will result in lamp flicker. For repeatable low light levels the BRITE input DC supply must be a very clean stable voltage source, at low dim inputs.

If you plan to completely remove R61 it is recommended that you ensure that a minimum voltage above zero remain on the BRITE input to prevent the above flicker problem. This minimum voltage may need to be adjusted for each individual inverter module. If you are using a pot to control the BRITE input then a separate trim pot on the low side would accomplish the same goal.

Both methods discussed will provide a lower duty cycle operation than is necessary in a 100:1 dimming application.

Careful consideration should be made with regard to display quality at these dimming levels. At very low brightness levels, even very small amounts of noise on the VBRITE line can cause flicker on the display, so special care must be given to grounding, filtering, and shielding the inverter from the digital logic and clock signals.

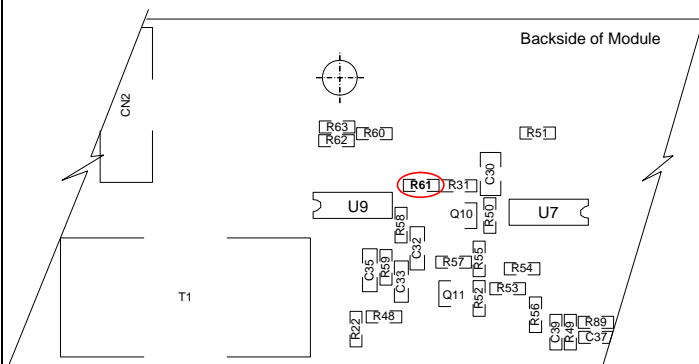


Figure 10 – Locating The Resistor on the LXMG1621-xx



RangeMAX™

LXMG1621-xx

DIGITAL DIMMING DUAL LAMP CCFL INVERTER MODULE

PRODUCTION DATA SHEET

NOTES

PRODUCTION DATA – Information contained in this document is proprietary to Microsemi and is current as of publication date. This document may not be modified in any way without the express written consent of Microsemi. Product processing does not necessarily include testing of all parameters. Microsemi reserves the right to change the configuration and performance of the product and to discontinue product at any time.