

LZ0P3800

1/4-type Built-in Lens Color CMOS Image Sensor with 110 k Pixels

DESCRIPTION

The LZ0P3800 is a 1/4-type (4.5 mm) 110 000-pixel built-in lens color CMOS (Complementary Metal Oxide Semiconductor) image sensor that consists of a timing generator (TG), a correlated double sampling (CDS) circuit, an auto gain control (AGC) circuit and an analog-to-digital converter (ADC) circuit. With small lens and WLCC-type flat package, possible to make ultra small color camera easily.

FEATURES

- Progressive scan
- Square pixel
- Compatible with CIF standard
- Number of effective pixels : 367 (H) x 291 (V)
- Number of optical black pixels
 - Horizontal : 13 front and 13 rear
 - Vertical : 4 front and 4 rear
- Pixel pitch : 9.4 μm (H) x 9.4 μm (V)
- R, G, and B primary color mosaic filters
- Image inversion function (horizontally and/or vertically)
- Power save mode
- Analog output and 8-bit digital output
- Variable gain control (3 to 30 dB)
- Variable electronic shutter (1/30 to 1/10 000 s)
- Single +3.0 V power supply
- Built-in optical low-pass-filter
- Integrated lens : 52° horizontal viewing angle
- Package
 - 36-pin WLCC* type
 - Base section size : 16 mm (H) x 13 mm (V)
- Package height : approx. 10 mm

* Window Leadless Chip Carrier

PIN CONNECTIONS

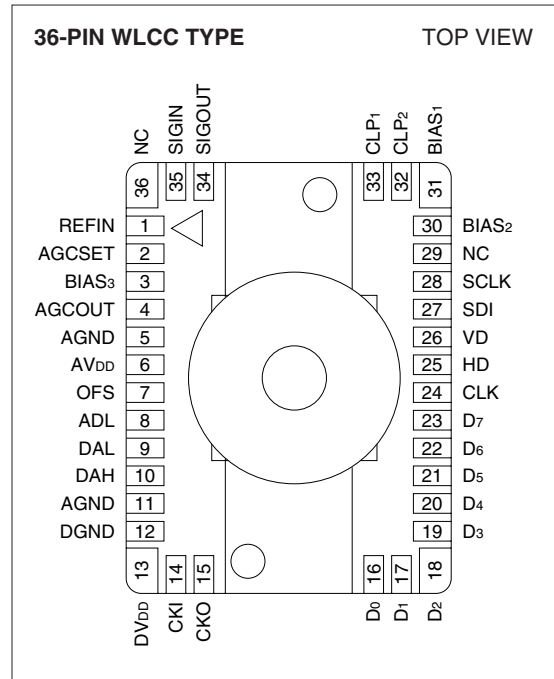

BLOCK DIAGRAM

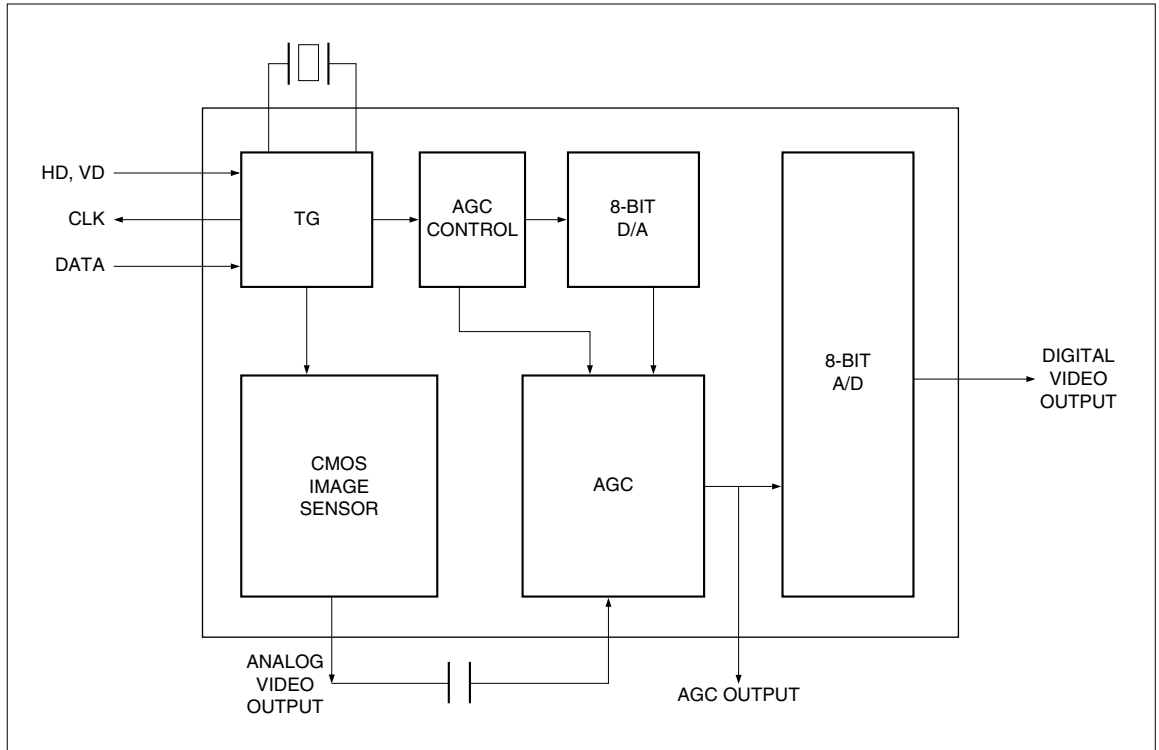

PIN DESCRIPTION

PIN NO.	SYMBOL	I/O	A/D	DESCRIPTION
1	REFIN	I	Analog	Reference voltage for analog input
2	AGCSET	–	Analog	Connect to AGC bias resistor
3	BIAS ₃	–	Analog	Analog bias voltage 3 for image sensor
4	AGCOUT	O	Analog	AGC output
5	AGND	–	Analog	Analog ground
6	AV _{DD}	–	Analog	Analog power supply
7	OFS	–	Analog	Offset bias voltage for AGC output
8	ADL	–	Analog	Bottom ADC reference voltage
9	DAL	–	Analog	Bottom DAC reference voltage
10	DAH	–	Analog	Top DAC reference voltage
11	AGND	–	Analog	Analog ground
12	DGND	–	Digital	Digital ground
13	DV _{DD}	–	Digital	Digital power supply
14	CKI	I	Digital	Clock input for oscillator
15	CKO	O	Digital	Clock output for oscillator
16	D ₀	O	Digital	ADC signal output (LSB)
17	D ₁	O	Digital	ADC signal output
18	D ₂	O	Digital	ADC signal output
19	D ₃	O	Digital	ADC signal output
20	D ₄	O	Digital	ADC signal output
21	D ₅	O	Digital	ADC signal output
22	D ₆	O	Digital	ADC signal output
23	D ₇	O	Digital	ADC signal output (MSB)
24	CLK	O	Digital	Clock output (9.0 MHz)
25	HD	I	Digital	Horizontal drive pulse input
26	VD	I	Digital	Vertical drive pulse input
27	SDI	I	Digital	Data input (AGC gain, offset, shutter control, etc.)
28	SCLK	I	Digital	Shift clock for data.
29	NC	–	–	No connection
30	BIAS ₂	–	Analog	Analog bias voltage 2 for image sensor
31	BIAS ₁	–	Analog	Analog bias voltage 1 for image sensor
32	CLP ₂	–	Analog	Analog bias voltage 2 for clamp circuit
33	CLP ₁	–	Analog	Analog bias voltage 1 for clamp circuit
34	SIGOUT	O	Analog	Analog image signal output
35	SIGIN	I	Analog	Analog image signal input
36	NC	–	–	No connection

ABSOLUTE MAXIMUM RATINGS(T_A = +25 °C)

PARAMETER	SYMBOL	RATING	UNIT
Power supply voltage	V _{DD}	-0.3 to +4.3	V
Input signal voltage	V _φ	-0.3 to V _{DD} +0.3	V
Storage temperature	T _{STG}	-20 to +70	°C

RECOMMENDED OPERATING CONDITIONS

PARAMETER	SYMBOL	MIN.	TYP.	MAX.	UNIT	NOTE
Power supply voltage	V _{DD}	2.7	3.0	3.3	V	
Operating temperature	T _{OPR}	-10	+25	+60	°C	
Oscillation frequency	f _{CK}		9.0		MHz	
Digital input voltage	LOW level	V _{φL}	0	0.2V _{DD}	V	1
	HIGH level	V _{φH}	0.8V _{DD}	V _{DD}	V	
Analog input voltage		(Connect to pin through a capacitor)				2
Analog bias voltage		(Connect to GND through a capacitor)				3

NOTES :

1. Applied to input pins HD, VD, SDI and SCLK.
2. Applied to input pins SIGIN and REFIN. Do not connect to DC directly.
3. Applied to pins BIAS₁, BIAS₂, BIAS₃, OFS, ADL, DAL, DAH, CLP₁ and CLP₂.
Do not connect to GND directly.

CHARACTERISTICS (1/30 s progressive scan readout mode)

(TA : +25 °C, Operating conditions : The typical values specified in "RECOMMENDED OPERATING CONDITIONS".
Color temperature of light source : 3 200 K)

- Measurement point : Analog image signal output (pin no. 34), before AGC circuit and AD converter.

PARAMETER	SYMBOL	MIN.	TYP.	MAX.	UNIT	NOTE
Standard output voltage	V _O		150		mV	1
Saturation output voltage	V _{SAT}	600	1 000		mV	2
Sensitivity (Green channel)	R	200	300		mV	3
Resolution (at center)			150		TV line	4
Resolution (at corner)			100		TV line	5
Shading			40		%	6
Difference of center position				±10	%	7
Supply current	I _{VDD}		10		mA	8

NOTES :

- The average output voltage of G signal in the central area (H/10, V/10) under uniform illumination.
The standard exposure conditions are defined as when V_O is 150 mV.
- The average output voltage of G signal in the central area (H/10, V/10) under 10 times exposure of the standard exposure conditions.
- The average output voltage of G signal in the central area (H/10, V/10) when a 1 000 lux light source with a white board of 90% reflector is imaged.
- The resolution in the central area (H/10, V/10) at which the image of the TV resolution chart (ex. EIAJ test chart) can be distinguished on the B/W video monitor when converted into composite video signals.
- The resolution in the peripheral area (image height : Y = 0.8) under the conditions mentioned above.
- Defined by the following formula at the brightness of standard output voltage : (V_{co}/V_{ce}) x 100 [%]
V_{co} : Output voltage at edge (image height : Y = 0.8) of the image (at video output).
V_{ce} : Output voltage at center of the image (at video output).
- The difference between the center position of image and that of the monitor. This is the ratio for the horizontal underscanning monitor size which includes the decentering eccentricity when turning the lens head one time.
- Total current of analog and digital power supplies, in the dark and at the standard load conditions.

LENS SPECIFICATIONS

PARAMETER	SPECIFICATION	NOTE
Construction	Single (non-spherical, plastic)	
Focal length	4.0 mm [TYP. : reference]	
F No.	2.8±5%	
Viewing angle	H : 52°, V : 40°, Diagonal : 65° [TYP. : reference]	
TV distortion	≤ -3.2%	1
Focus adjustment range	∞ to 10 cm	2
Torque of focusing	0.00005 to 0.001 N · m	3

NOTES :

- TV distortion is defined by the formula, $(\Delta y/y) \times 100$ [%] at capturing rectangular pattern sized horizontal by vertical as 4 by 3.
"y" is defined as the vertical height of the center of the horizontal line.
Δy is defined as the difference between the vertical height of the center of the horizontal line and an edge of it.
 - The best focus point of an object can be obtained by turning the lens head within this range.
 - Torques which are necessary for turning the lens.
- * Be careful not to remove the lens head by turning it counterclockwise too much when adjusting macro.

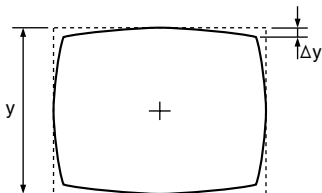

PIXEL STRUCTURE

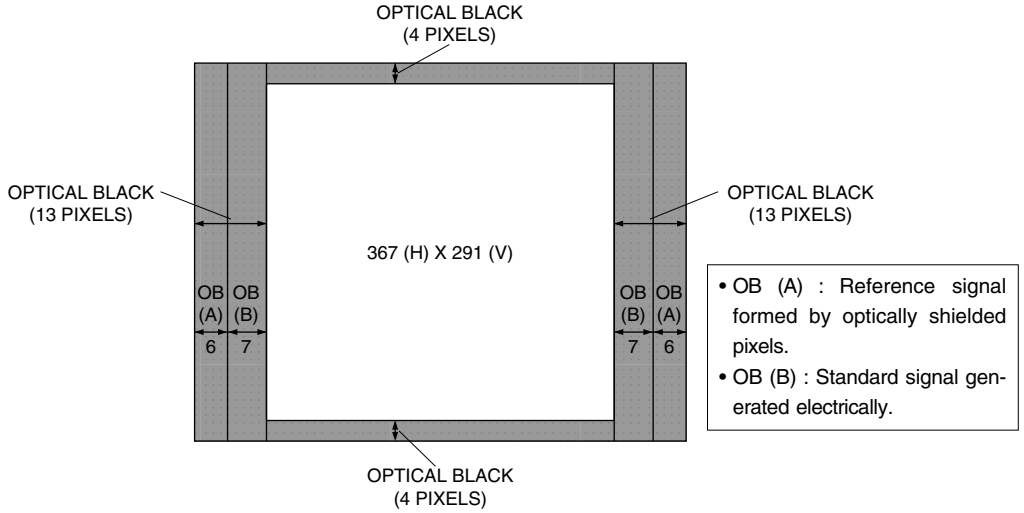

COLOR FILTER ARRAY

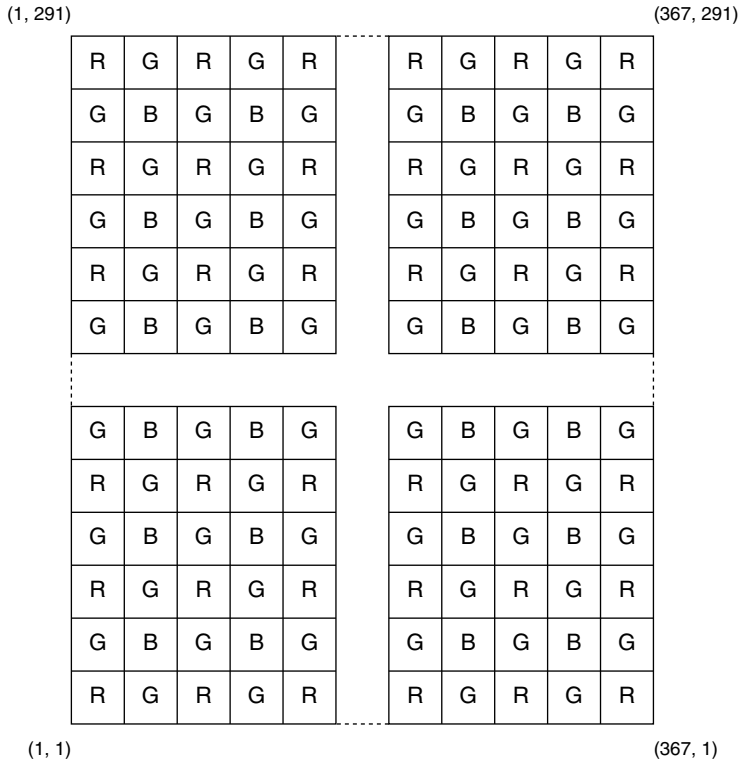

TIMING CHART

HORIZONTAL PULSE TIMING

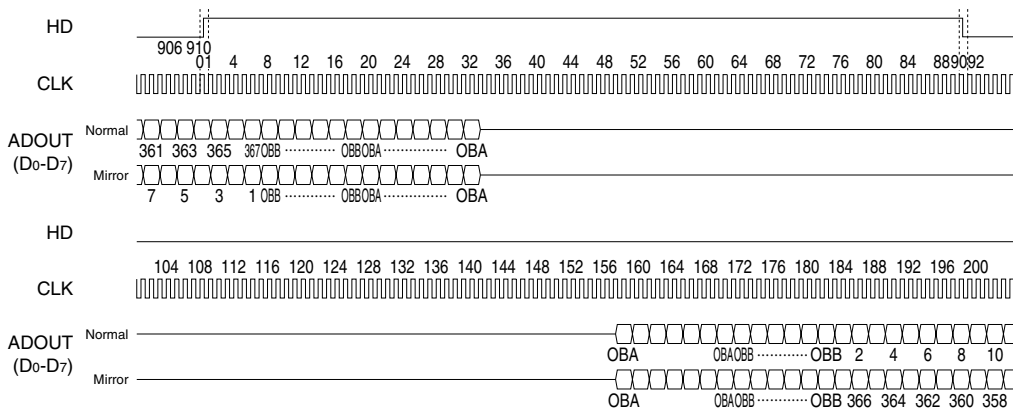

- The rising edge of the HD pulse must be between two rising edges of CLK (0) and CLK (1).
- The falling edge of the HD pulse must be between two rising edges of CLK (78) and CLK (79).

PHASE RELATIONS BETWEEN DIGITAL OUTPUT (ADOUT) AND CLOCK (CLK)

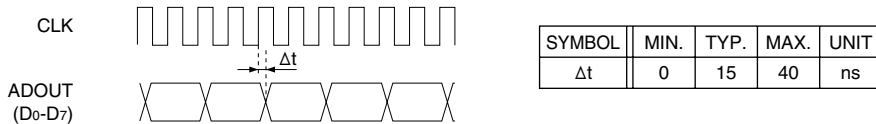

VERTICAL PULSE TIMING

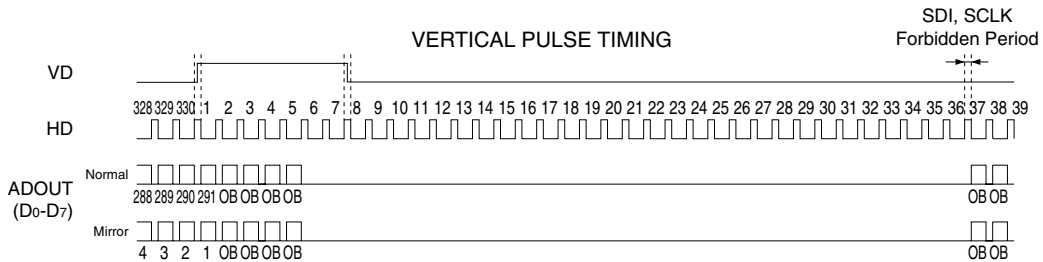

- The rising edge and falling edge of the VD pulse must be in high period of the HD pulses.

SERIAL DATA TIMING (SDI, SCLK)

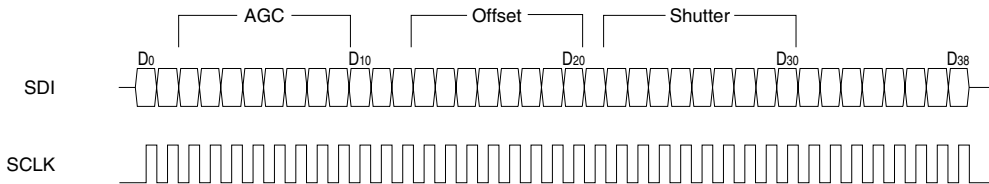

- Data in SDI are taken at the rising edge of SCLK.
- Clock frequency of SCLK should be 1/16 of that of CLK.
- Do not insert the SDI and SCLK pulses between 36H* and 37H*. Refer to "VERTICAL PULSE TIMING".
- Refer to "SERIAL DATA INPUTS" for the contents of serial data from D0 to D38.

* It means ordinal number of the HD pulse.

SERIAL DATA INPUTS

DATA	NAME	FUNCTION	
D0		Not used.	
D1		(Fix to low level.)	
D2	AGC7 (MSB)	Auto gain control (0 to 20 dB)	
D3	AGC6		
D4	AGC5		
D5	AGC4		
D6	AGC3		
D7	AGC2		
D8	AGC1		
D9	AGC0 (LSB)		
D10			Not used.
D11		(Fix to low level.)	
D12			
D13	OFS7 (MSB)	Offset level control of AGC output (0.9 to 1.5 V)	
D14	OFS6		
D15	OFS5		
D16	OFS4		
D17	OFS3		
D18	OFS2		
D19	OFS1		
D20	OFS0 (LSB)		
D21		Not used. (Fix to low level.)	
D22	SHT8 (MSB)	Shutter speed control (Exposure time is 1 to 1/330 frame period.)	
D23	SHT7		
D24	SHT6		
D25	SHT5		
D26	SHT4		
D27	SHT3		
D28	SHT2		
D29	SHT1		
D30	SHT0 (LSB)		
D31	MIRH		H : Horizontal mirror inversion image, L : Normal image
D32	MIRV		H : Vertical mirror inversion image, L : Normal image
D33	SAD1 (MSB)	Phase selection of AD clock (Fix to low level.)	
D34	SAD0 (LSB)		
D35	MAX2 (MSB)	Selection of fixed gain (3 to 10 dB)	
D36	MAX1		
D37	MAX0 (LSB)		
D38	LPMD	H : Power save mode (AGC and AD off), L : All active	

Setting of Auto Gain Control

- One LSB of the gain code represents approximately 0.078 dB.
- Nominal gain values at typical codes are shown below.

AUTO GAIN CONTROL (dB)	D2	D3	D4	D5	D6	D7	D8	D9
0	L	L	L	L	L	L	L	L
1	L	L	L	L	H	H	L	H
2	L	L	L	H	H	L	H	L
3	L	L	H	L	L	H	H	L
4	L	L	H	H	L	L	H	H
5	L	H	L	L	L	L	L	L
6	L	H	L	L	H	H	L	H
7	L	H	L	H	H	L	L	H
8	L	H	H	L	L	H	H	L
9	L	H	H	H	L	L	H	H
10	H	L	L	L	L	L	L	L
11	H	L	L	L	H	H	L	L
12	H	L	L	H	H	L	L	H
13	H	L	H	L	L	H	H	L
14	H	L	H	H	L	L	H	H
15	H	L	H	H	H	H	H	H
16	H	H	L	L	H	H	L	L
17	H	H	L	H	H	L	L	H
18	H	H	H	L	L	H	H	L
19	H	H	H	H	L	L	H	L
20	H	H	H	H	H	H	H	H

Setting of Offset Level

- One LSB of the offset code represents approximately 0.002 V.
- Nominal offset values at typical codes are shown below.

OFFSET LEVEL (V)	D13	D14	D15	D16	D17	D18	D19	D20
0.9	L	L	L	L	L	L	L	L
1.0	L	L	H	L	H	L	H	H
1.1	L	H	L	H	L	H	L	H
1.2	H	L	L	L	L	L	L	L
1.3	H	L	H	L	H	L	H	L
1.4	H	H	L	H	L	H	L	H
1.5	H	H	H	H	H	H	H	H

Setting of Shutter Speed

- One LSB of the shutter speed code represents 1H, where 1H is the HD pulse period.
- Shutter speed values at typical codes are shown below.

SHUTTER SPEED (Exposure Time Unit : 1H)	D22	D23	D24	D25	D26	D27	D28	D29	D30
330	L	L	L	L	L	L	L	L	L
329	L	L	L	L	L	L	L	L	H
328	L	L	L	L	L	L	L	H	L
.									
300	L	L	L	L	H	H	H	H	L
.									
.									
200	L	H	L	L	L	L	L	H	L
.									
.									
100	L	H	H	H	L	L	H	H	L
.									
.									
10	H	L	H	L	L	L	L	L	L
.									
3	H	L	H	L	L	L	H	H	H
2	H	L	H	L	L	H	L	L	L
1	H	L	H	L	L	H	L	L	H

Setting of Fixed Gain

- One LSB of the gain code represents 1 dB.

FIXED GAIN (dB)	D35	D36	D37
3	L	L	L
4	L	L	H
5	L	H	L
6	L	H	H
7	H	L	L
8	H	L	H
9	H	H	L
10	H	H	H

EXAMPLE OF OPERATION CIRCUIT

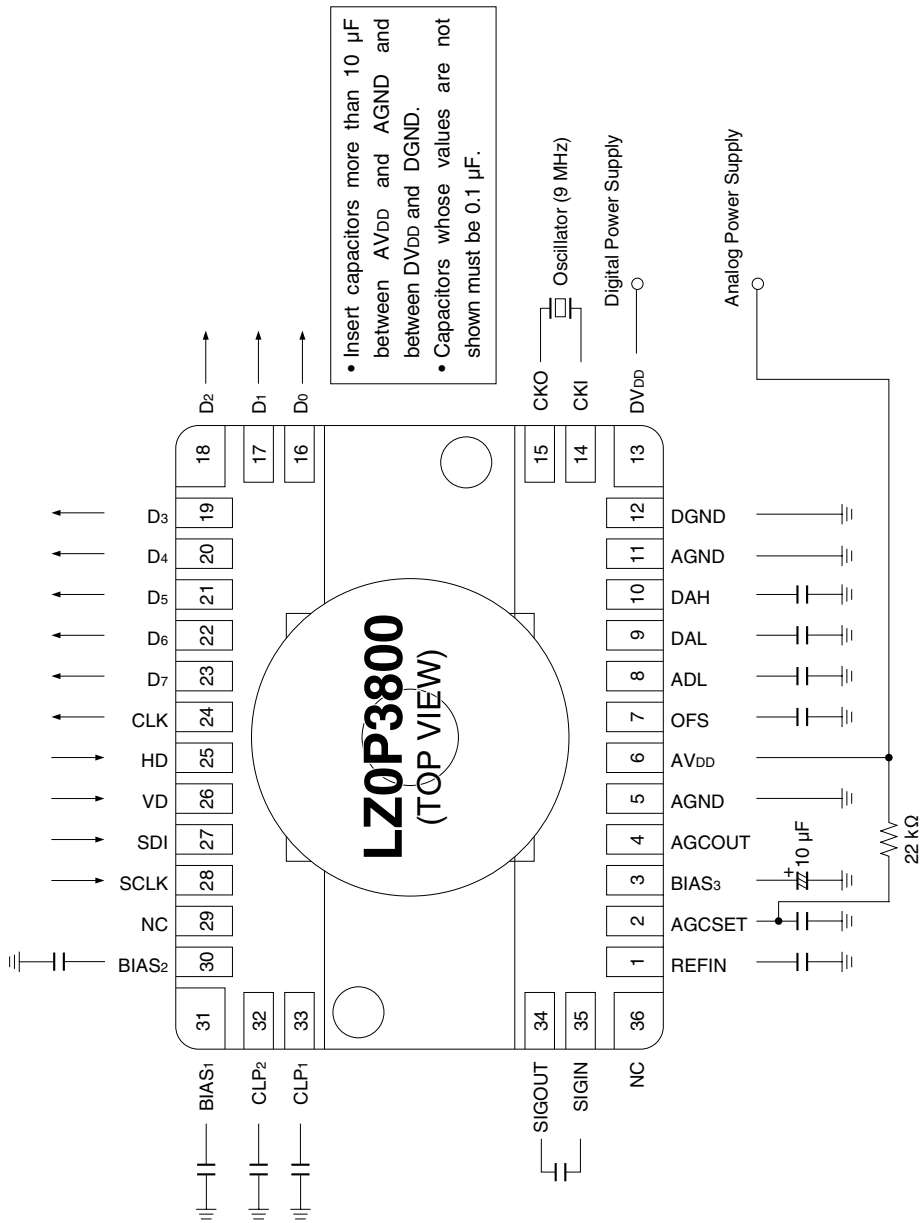

PACKAGE

(Unit : mm)

36 WLCC TYPE

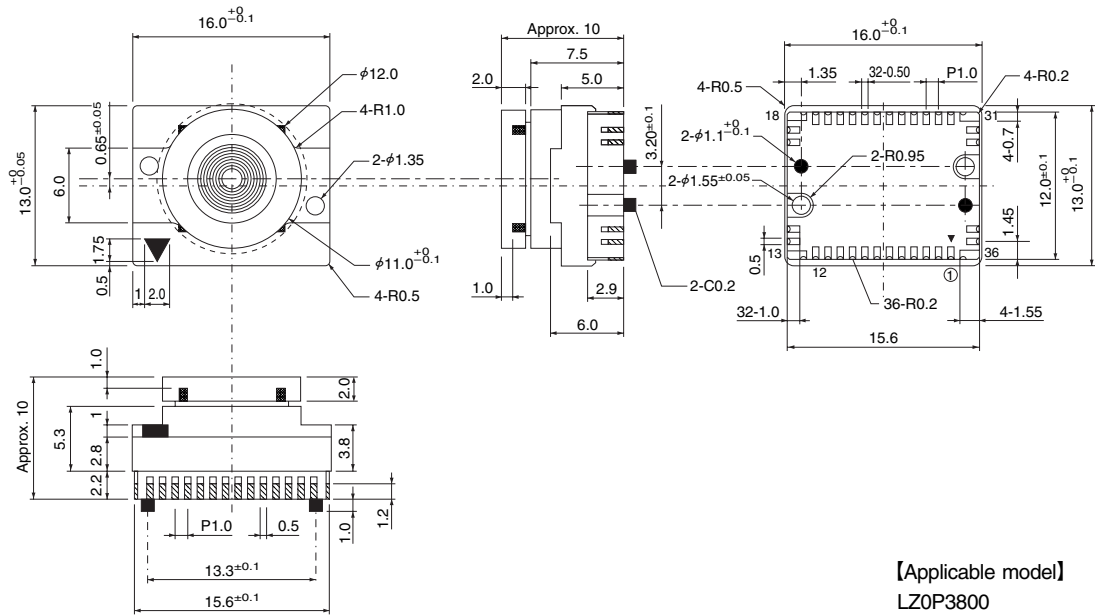

PRECAUTIONS FOR BUILT-IN LENS CMOS IMAGE SENSORS

1. Package Breakage

In order to prevent the package, the lens holder, and the lens from being broken, follow the instructions below :

- 1) The CMOS image sensor is a precise optical component and the package-base material is ceramic.

Therefore,

- Take care not to drop the device when mounting, handling, or transporting.
- Avoid giving a shock to the package. Especially when leads are fixed to the socket or the circuit board, a small shock could break the package more easily than when the package isn't fixed.

- 2) When adjusting the focus, screw the lens holder to the circuit board before soldering the leads. At that time, make sure to use a circuit board with plenty of strength, and to avoid the package and the lens holder from being broken, the following screw and clamp torque are recommended.

- Recommended mounting screw :
ϕ1.7 tapping screw (B-tight type),
Length, L = the thickness of the circuit board + 6 mm
- Recommended clamp torque : 0.012 N·m [however, when the thickness of the circuit board is thinner than t = 2.0 mm]

- 3) If any damage or breakage occurs on the surface of the lens, its characteristics could deteriorate.

Therefore,

- Do not hit the lens.
- Do not give a shock large enough to cause distortion.
- Do not scrub or scratch the surface of the lens.

– Even a soft cloth or applicator, if dry, could cause dust to scratch the lens.

2. Electrostatic Damage

As compared with general MOS-LSI, CMOS image sensor has lower ESD. Therefore, take the following anti-static measures when handling the CMOS image sensor :

- 1) Always discharge static electricity by grounding the human body and the instrument to be used. To ground the human body, provide resistance of about 1 MΩ between the human body and the ground to be on the safe side.
- 2) When directly handling the device with the fingers, hold the lens holder and do not touch the lead.
- 3) To avoid generating static electricity,
 - a. do not scrub the device with cloth etc.
 - b. do not attach any tape or labels.
- 4) When storing or transporting the device, put it in a container of conductive material.

3. Dust and Contamination

Dust or contamination on the surface of the lens and the inside of the lens holder could deteriorate the output characteristics or cause a scar. In order to minimize dust or contamination on the device, take the following precautions :

- 1) Do not remove the lens from the body. Especially when adjusting macro, be careful not to remove the lens by turning it counter-clockwise too much.
- 2) Do not touch the surface of the lens with the fingers. If dust or contamination gets on the surface of the lens, the following cleaning method is recommended :
 - Handle the built-in lens CMOS image sensor in a clean environment such as a cleaned booth. (The cleanliness level should be, if possible, class 1 000 at least.)

- Dust from static electricity should be blown off with an ionized air blower. For anti-electrostatic measures, however, ground all the leads on the device before blowing off the dust.
- The contamination on the surface of the lens should be wiped off with a clean applicator soaked in isopropyl alcohol. Wipe slowly and gently in one direction only.
 - Frequently replace the applicator and do not use the same applicator to clean more than one device.
- Make sure there is no dust or contamination on the lens and screw it on the lens holder.
- Do not put too much force onto the lens and the lens holder while soldering.
- Be careful not to let the soldering iron touch the lens holder.
 - Soldering can be quickly/neatly done by laying the soldering iron so it lightly touches the border between the package and the circuit board and sliding it in sideways.

4. Other

- 1) Soldering should be manually performed within 2 seconds per pin at 400 °C maximum at soldering iron.
 - Use ESD-measured soldering iron
 - The conditions of the soldering time in which the soldering iron touches the package.
 - In case where the soldering may exceed 2 seconds per pin, resume the work after the device returns to normal temperature.
- 2) There is no guarantee of the performance of the device which has been removed or resoldered after being soldered once under the conditions mentioned above.
 - In case there seems to be an inferior device, consult with our sales office before removing it.
- 3) Avoid using or storing the CMOS image sensor at high temperature or high humidity as it is a precise optical component. Do not give a mechanical shock to the CMOS image sensor.
- 4) Do not expose the device to strong light. For the color device, long exposure to strong light will fade the color of the color filters.