

Low-Voltage / High Q Si Hyperabrupt Varactors

MA4ST200 Series
V2

Features

- Surface Mount Packages (SOT-23, SOT-323, SOD-323)
- High Q at Low Voltages
- High Capacitance Ratio at Low Voltages
- SPC Process for Superior C-V Repeatability
- Available as Single and Common Cathode Pairs Tape and Reel Packaging
- Designed for Commercial Wireless Applications
- Lead-Free (RoHS Compliant) equivalents available with 260°C reflow compatibility

Description

M/A-COM's MA4ST200 series is a ion-implanted, hyperabrupt junction, silicon tuning varactors in SOT-23, SOT-323, and SOD-323 surface mount packages. This series of varactors is designed for high Q and low voltage operation. Each varactor type has a Q greater than 400 at -2 V. These diodes are offered with standard Sn/Pb plating, as well as 100% matte Sn plating on our RoHS compliant equivalent devices.

Applications

The MA4ST200 series tuning varactors are useful for wide band tuning and low phase noise applications where the supply voltage is limited to 5 volts or less. These varactors have been specifically designed for use in the wireless communications up to the 2.4 GHz band. Applications include VCOs and voltage tuned filters.

RoHS Compliant parts

Part Number	RoHS Compliant Base Part Number
MA4ST230	MAVR-000230
MA4ST240	MAVR-000240
MA4ST250	MAVR-000250

Absolute Maximum Ratings @ T_A=+25 °C (Unless Otherwise Noted)¹

Parameter	Absolute Maximum
Reverse Voltage	12 V
Forward Current	50 mA
Total Power Dissipation	250 mW
Operating Temperature	-55 °C to +125 °C
Storage Temperature	-55 °C to +125 °C

1. Operation of this device above any one of these parameters may cause permanent damage.
2. Please refer to application note M538 for surface mounting instructions

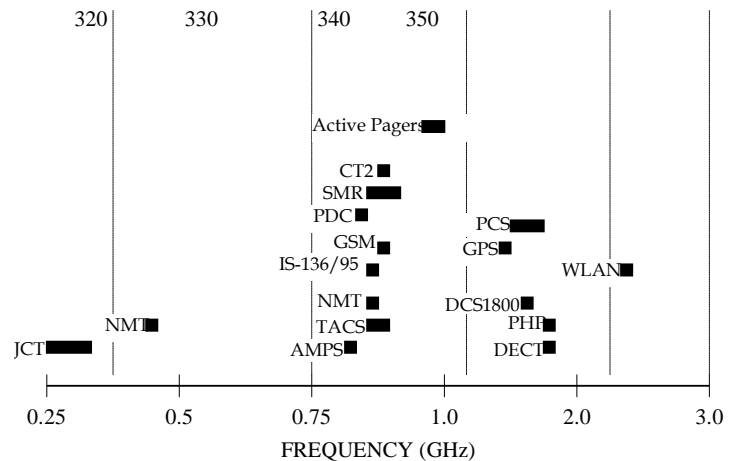
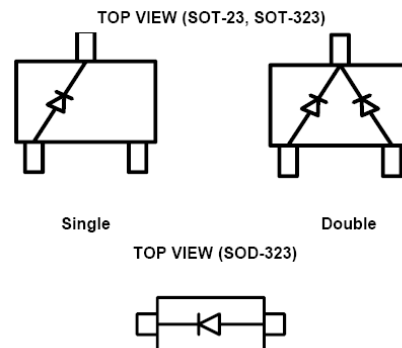

Fig. 1 Typical Device Selection by Frequency

Configurations



¹ M/A-COM Inc. and its affiliates reserve the right to make changes to the product(s) or information contained herein without notice. M/A-COM makes no warranty, representation or guarantee regarding the suitability of its products for any particular purpose, nor does M/A-COM assume any liability whatsoever arising out of the use or application of any product(s) or information.

Low-Voltage / High Q Si Hyperabrupt Varactors

MA4ST200 Series
V2

Electrical Specifications @ $T_A = +25\text{ }^\circ\text{C}$

Breakdown Voltage @ $I_R = 10\mu\text{A}$, $V_b = 12\text{ V}$ Minimum

Reverse Leakage Current @ $V_R = 10\text{V}$, $I_R = 100\text{ nA}$ Maximum

Part Number Base	RoHS Compliant Part Number Base ¹	C_T^2				Capacitance Ratio	Q Factor
		(pF)		(pF)			
		f=1 MHz, $V_R=2.0$		f=1MHz, $V_R=4.0\text{V}$		$C_{T0.5}/C_{T4.0}$	f=50 MHz, $V_R = 2.0\text{V}$
		Min.	Nom.	Max.	Max.	Typ.	Min.
MA4ST230	MAVR-000230-XXXXXX	4.5	5.0	6.0	3.1	3.5	400
MA4ST240	MAVR-000240-XXXXXX	3.0	3.5	4.2	2.3	3.5	450
MA4ST250	MAVR-000250-XXXXXX	2.3	2.7	3.5	1.8	3.5	450

¹ The suffix defines package style, configuration and packaging information. Contact representative for complete part identification. Example : The MA4ST250-1141T RoHS compliant version is MAVR-000250-11410T .

² Capacitance @ 1 MHz

Spice Model

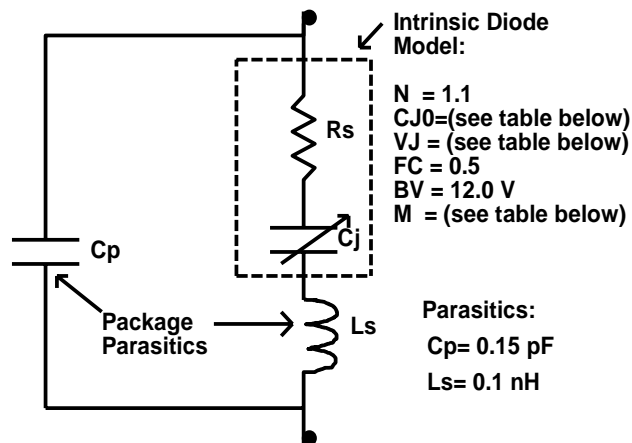

Part No.	RoHS Compliant Base Part No.	CJ0 (pF)	VJ (V)	M
MA4ST230	MAVR-000230	12.0	4.085	2.228
MA4ST240	MAVR-000240	8.16	4.930	2.520
MA4ST250	MAVR-000250	6.19	4.774	2.458

**Low-Voltage / High Q
Si Hyperabrupt Varactors**

MA4ST200 Series
V2

Typical Performance Curves

TOTAL CAPACITANCE vs REVERSE VOLTAGE at 1 MHz

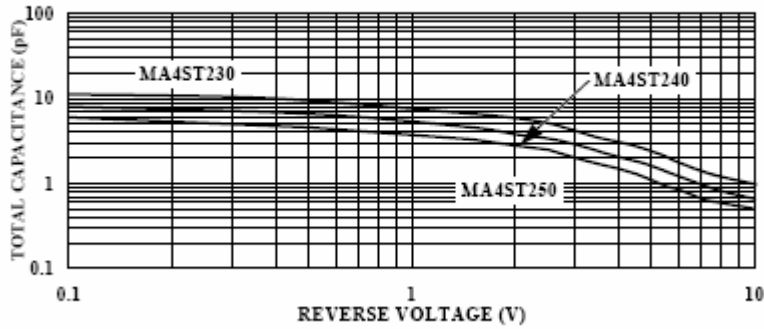

NOMINAL Q at 50 MHz vs REVERSE VOLTAGE

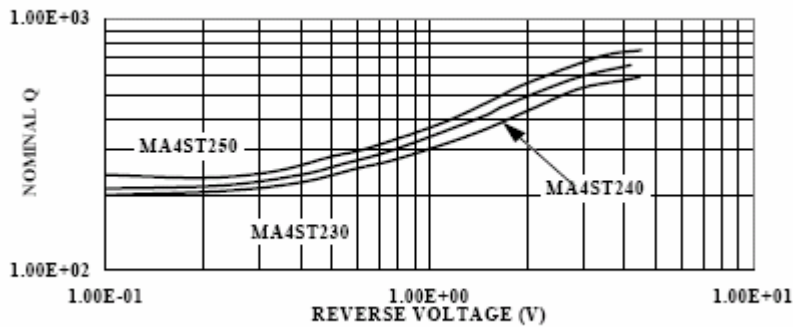

NOMINAL CHANGE in CAPACITANCE with TEMPERATURE

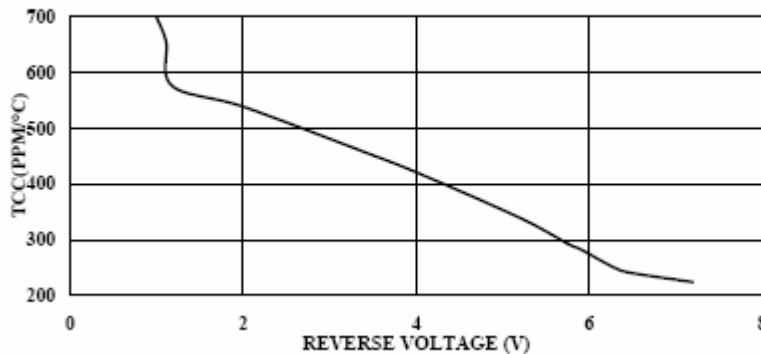

**Low-Voltage / High Q
Si Hyperabrupt Varactors**

MA4ST200 Series
V2

Case Styles

SOD-323

Case Style 1141

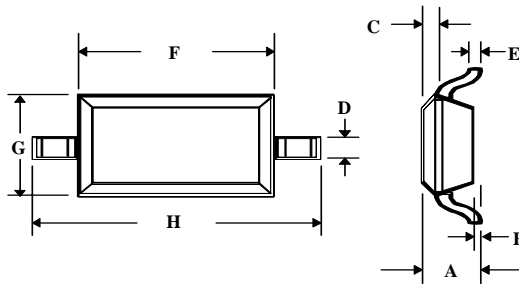

DIM.	INCHES		MILLIMETERS	
	MIN.	MAX.	MIN.	MAX.
A	—	0.043	—	1.1
B	—	0.004	—	0.1
C	—	0.008	—	0.2
D	0.010	0.016	0.25	0.4
E	0.003	0.006	0.08	0.15
F	0.063	0.075	1.6	1.9
G	0.045	0.057	1.15	1.45
H	0.091	0.106	2.3	2.7

SC-70, 3 Lead

Case Style 1146

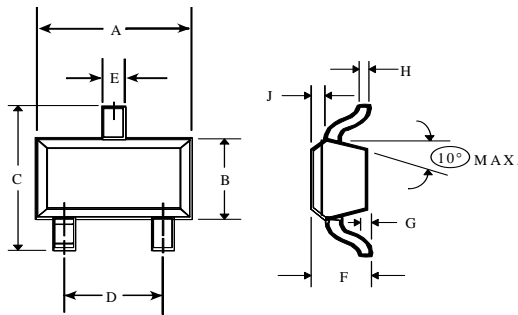

DIM.	INCHES		MILLIMETERS	
	MIN.	MAX.	MIN.	MAX.
A	0.071	0.087	1.80	2.20
B	0.045	0.053	1.15	1.35
C	0.071	0.094	1.80	2.40
D	0.047	0.057	1.19	1.45
E	0.010	0.016	0.25	0.41
F	0.031	0.039	0.80	1.00
G	0.000	0.004	0.00	0.10
H	0.004	0.007	0.10	0.18
J	0.004	0.010	0.10	0.25

SC-79

Case Style 1279

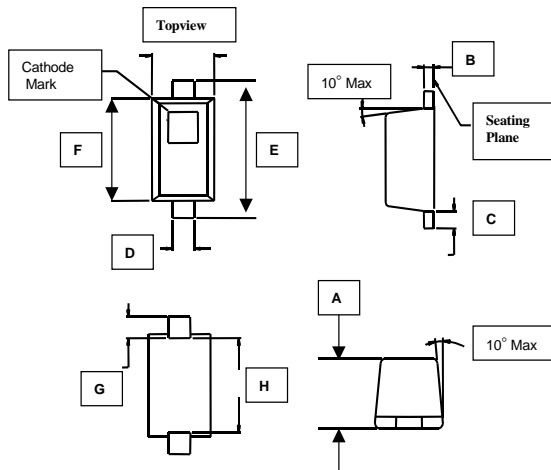

DIM.	INCHES		MILLIMETERS	
	MIN.	MAX.	MIN.	MAX.
A	0.020	0.028	0.50	0.71
B	0.003	0.008	0.08	0.20
C	0.006	0.010	0.15	0.25
D	0.010	0.014	0.25	0.36
E	0.059	0.067	0.08	0.15
F	0.043	0.051	1.50	1.30
G	0.011	0.012	0.28	0.30
H	0.037 typical	0.043	0.94	1.09

Low-Voltage / High Q Si Hyperabrupt Varactors

MA4ST200 Series
V2

Mounting Information

The illustration indicates the recommended mounting pad configuration for the SC-79, SOT-323 and SOD-323 packages. Solder paste containing flux should be screened onto the pads to a thickness of 0.005- 0.007 inches. The plastic package is placed in position, firmly adhering to the solder paste.

Permanent attachment is performed by a reflow soldering procedure during which the tab temperature does not exceed +275 °C and the body temperature does not exceed +250 °C, for standard models and +260 °C for the RoHS compliant devices.

These varactors are available in the three case styles shown. When ordering, specify the desired case style by adding the case designation (287 for SOT-23, 1146 for SOT-323, 1141 for SOD-323) as a suffix to the model number. For example, MA4ST230-1141 specifies the MA4ST230 varactor in the SOD-323 package. The model number indicated is for a single varactor. Common cathode pairs are available in SOT-23 package, and are specified by adding "CK" to the end of the model number. For example MA4ST230CK-287 specifies the MA4ST230 varactor in common cathode pairs.

For RoHS Compliant Parts, use the Following
Suffixes for the Given Package Style
(After the Base P/N) :

SC-79 : 12790T
SOD-323 : 11410T
SOT-323 : 1146FT

As example, the RoHS P/N for the Base P/N
MA4VR-000230 in SOD-323 is :
MAVR-000230-1146FT.

**Please refer to Application Note M538 for surface
mounting instructions.**

SC-79

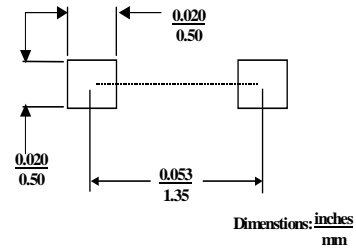

SOD-323

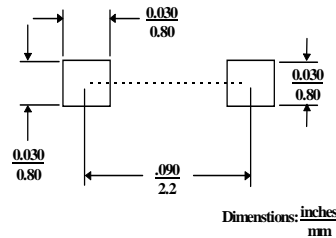

SOT-323

