

HMIC PIN Diode Variable Attenuator
1.70-2.20 GHz

MA4VAT2000-1277T
V2

Features

- RoHs and ELV compliant
- Bandwidth: 1.70 GHz to 2.20 GHz
- 1.2 dB Insertion Loss, Typical
- 1.4:1 VSWR, Typical
- 24 dB Attenuation, Typical
- 40 dBm IIP3, Typical (1MHz Offset, @ +0dBm Pinc)
- 0-1.5 Volt Control Voltage.
- User can add an External Resistor for higher D.C. Voltage requirements.

Extra Features

- Usable Bandwidth: 1.20 GHz to 2.50 GHz
- 1.5 dB Insertion Loss, Max
- 2:1 VSWR, Max
- 23 dB Attenuation, Max

Description and Applications

M/A-COM's MA4VAT2000-1277T is a HMIC PIN Diode Variable Attenuator which utilizes an integrated 90 degree 3dB hybrid with a pair of Silicon PIN Diodes to perform the required attenuation function as Voltage (Current) is applied. This device operates from 0 to 1.5 Volts at 260 uA typical control current for maximum attenuation. The user can add external biasing resistors to the bias ports for higher voltage requirements as required.

M/A-COM's MA4VAT2000-1277T PIN Diode Variable Attenuator is designed for AGC Circuit Applications requiring:

- Lower Insertion Loss
- Lower distortion through attenuation
- Larger dynamic range for wide spread spectrum applications

MLP 3mm Package
(Circuit Side View)

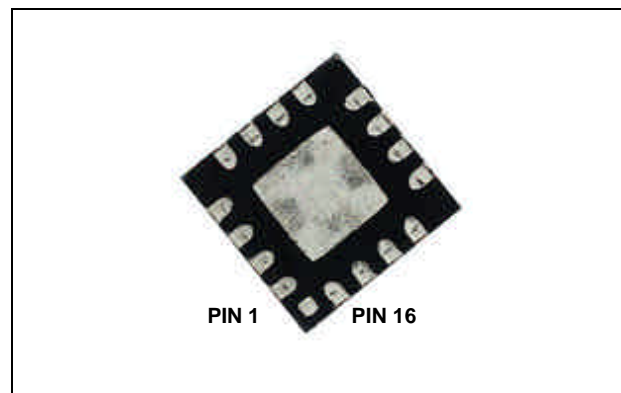

PIN Configuration

PIN	Function	PIN	Function
1	GND	9	DC2
2	GND	10	GND
3	GND	11	GND
4	GND	12	DC1
5	GND	13	GND
6	RF2	14	GND
7	GND	15	RF1
8	GND	16	GND

Center Paddle is RF and D.C. Ground
RF Input/Output Ports are Functionally Symmetrical

Absolute Maximum Ratings^{1,2}

Parameter	Maximum Ratings
Operating Temperature	-40 °C to +85 °C
Storage Temperature	-65 °C to +150 °C
Junction Temperature	+175 °C
RF C.W. Incident Power	+33 dBm C.W.
Reversed Current @ -30 V	I -50nA I
Control Current	50mA per Diode

1. All the above are at Room Temperature except as noted
2. Exceeding the above Limits may cause permanent damage

**HMIC PIN Diode Variable Attenuator
1.70-2.20 GHz**

**MA4VAT2000-1277T
V2**

Electrical Specifications @ +25 °C

Parameter	Frequency Band	Unit	Min	Typ	Max
No DC Bias Low Loss State					
Insertion Loss	1.70 GHz – 2.20 GHz	dB	-	1.2	1.4
Input Return Loss		dB	11	16	-
Output Return Loss		dB	11	16	-
P1dB		dBm	30	33	-
IIP3		dBm	37	40	-
Control Voltage		V	-	0V @ 0uA	-
DC Bias RF Attenuation State					
Maximum Attenuation	1.70 GHz – 2.20 GHz	dB	23	25	-
Input Return Loss @ Max Attenuation		dB	17	20	-
Output Return Loss @ Max Attenuation		dB	17	20	-
IIP3		dBm	15	21	-
Control Voltage @ Max Attenuation		V	-	1.50V @ 260uA	-

Typical RF Performance Over Industry Designated RF Frequency Bands

Band		Freq	I. Loss	Att.	R. Loss	IIP3	Phase -Relative-
		(MHz)	(dB)	(dB)	(dB)	(dBm)	(Degree)
DCS	RX	1710-1785	1.2	23	13	40	-20°
	TX	1805-1880	1.2	23	13	40	
PCS	RX	1850-1910	1.2	23	13	40	-20°
	TX	1930-1990	1.4	23	13	40	
UMTS	RX	1920-1980	1.4	23	11	40	-25°
WCDMA/CDMA	TX	2110-2170	1.5	23	11	40	
TD-S-CDMA	-	2010-2025	1.4	23	11	40	-25°
SCDMA	-	1800-2200	1.8	23	11	40	-25°

1. All are typical values only.
2. Relative phase is the measured Insertion Phase Difference between Insertion Loss and the 20dB Attenuation State.
(Please refer to the plots below)

**HMIC PIN Diode Variable Attenuator
1.70-2.20 GHz**

**MA4VAT2000-1277T
V2**

Plots of Typical RF Characteristics @ + 25 °C

Typical Insertion Loss & Attenuation Plot

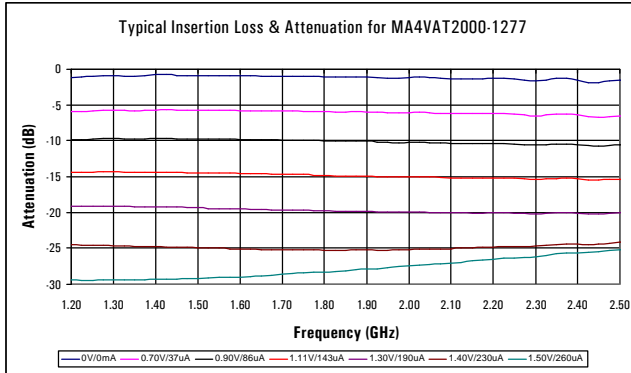

Typical Attenuation Vs Voltage Plot (@ 1950 MHz)

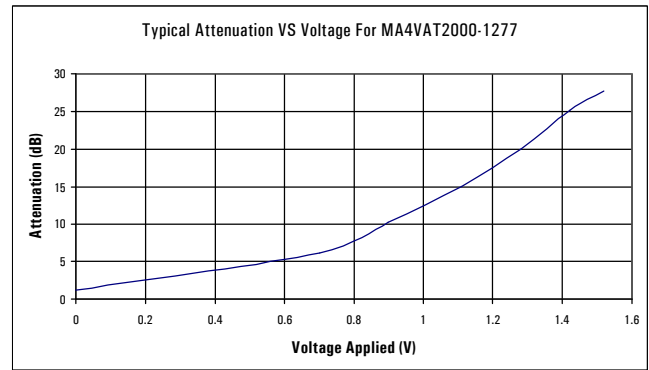

Typical Return Loss @ All Attenuation Levels Plot

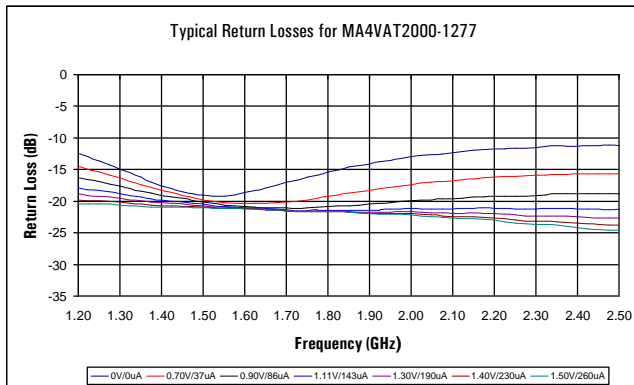

Typical IIP3 Vs Attenuation Plot

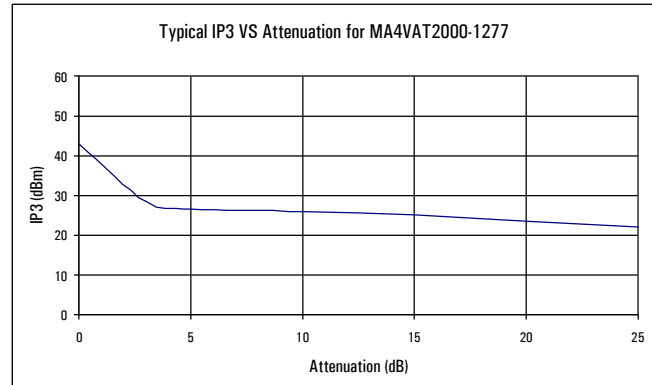

Typical Relative Phase Shift Per Attenuation (Voltage) Plot

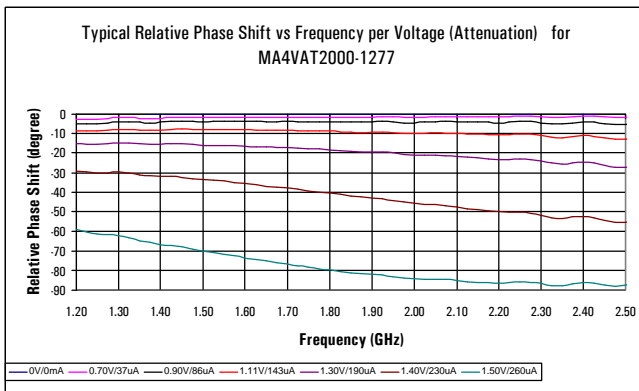

For Reference ONLY:

- Low Loss = 0V, @0uA
- 5 dB Attenuation = 0.90V, @86uA
- 10 dB Attenuation = 1.11V, @143uA
- 15 dB Attenuation = 1.30V, @190uA
- 20 dB Attenuation = 1.40V, @230uA
- 25 dB Attenuation = 1.50V, @260uA

HMIC PIN Diode Variable Attenuator
1.70-2.20 GHz

MA4VAT2000-1277T
V2

Package PIN Designation, External Components, and Equivalent Circuit

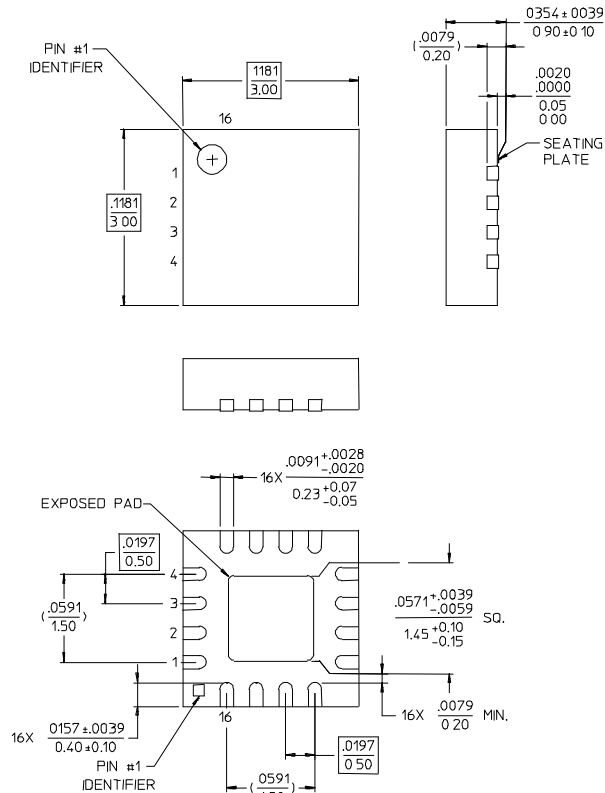

NOTES: 1. RBFBRNCB JDBDC M0-220, VAR. VBBD-1 FOR ADDITIONAL DIMENSIONAL AND TOLERANCE INFORMATION.
2. RBFBRNCB S2083 APPLICATION NOTE FOR PCB FOOTPRINT INFORMATION
3. ALL DIMENSIONS SHOWN AS INCHES/MM

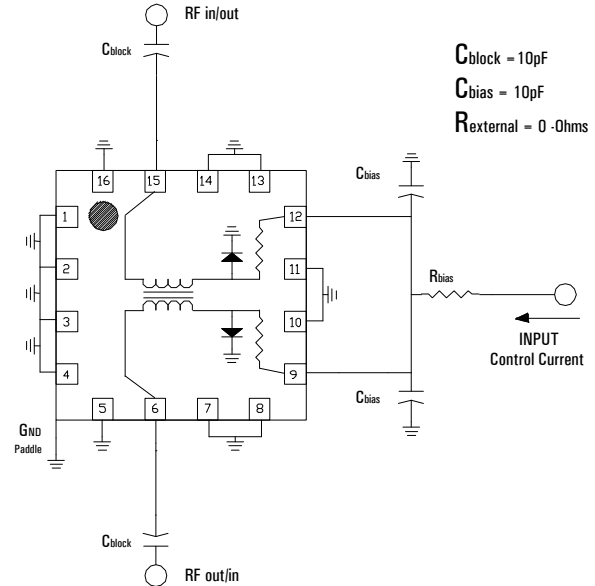

Ordering Information

Part Number	Package
MA4VAT2000-1277T	Tape and Reel