

**RF Driver Amplifier
250 - 4000 MHz**

**MAAMSS0048
V4**

Features

- Output Intercept Point of +40 dBm over a 20 dB Input Power Range
- Broadband Operation
- Excellent ACPR performance
- Lead-Free SOT-89 Package
- 100% Matte Tin Plating over Copper
- Halogen-Free “Green” Mold Compound
- RoHS* Compliant and 260°C Reflow Compatible

Description

M/A-COM’s MAAMSS0048 RF driver amplifier is a GaAs MMIC which exhibits exceptional linearity performance over a dynamic range greater than 20 dB, as well as high gain in a lead-free miniature SOT-89 surface mount plastic package. The device runs off a single +5 volt supply and draws 160 mA typically.

The MAAMSS0048 is fabricated using an HBT process to realize low current and high linearity. The process features full passivation for increased performance and reliability.

Functional Schematic

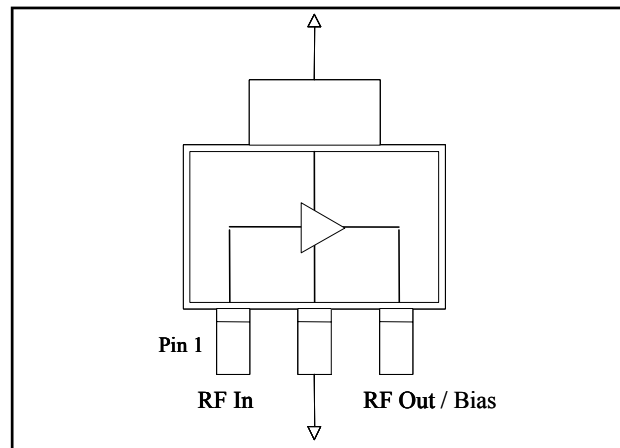

Pin Configuration

Pin No.	Function	Pin No.	Function
1	RF Input	3	RF Output/ Bias
2	Ground		

Ordering Information¹

Part Number	Package
MAAMSS0048	Bulk Packaging
MAAMSS0048SMB-01	900 MHz Configuration
MAAMSS0048SMB-02	1900 MHz Configuration
MAAMSS0048SMB-03	2150 MHz Configuration
MAAMSS0048TR-3000	3000 piece reel

1. Reference Application Note M513 for reel size information.

Maximum Operating Conditions²

Parameter	Maximum Operating Conditions
Junction Temperature ³	160°C
RF Output Power	27 dBm
Operating Temperature	-40°C to +85°C

2. Operating at or within these conditions will ensure MTTF > 1 x 10⁶ hours.
3. Typical thermal resistance (θ_{jc}) = 80°C/W.

Absolute Maximum Ratings^{4,5}

Parameter	Absolute Maximum
RF Output Power	28 dBm
Voltage	6 volts
Storage Temperature	-65°C to +150°C
Junction Temperature	200°C

4. Exceeding any one or combination of these limits may cause permanent damage to this device.
5. M/A-COM does not recommend sustained operation near these survivability limits.

* Restrictions on Hazardous Substances, European Union Directive 2002/95/EC.

**RF Driver Amplifier
250 - 4000 MHz**

**MAAMSS0048
V4**

Electrical Specifications: $T_A = +25^\circ\text{C}$, $V_{CC} = +5\text{ V}$, $Z_0 = 50\ \Omega$

Parameter	Test Conditions	Units	Min.	Typ.	Max.
Gain	900 MHz	dB	19.5	21.0	22.5
	1900 MHz	dB	14.5	16.0	17.5
	2140 MHz	dB	14.0	15.5	17.0
Output IP3	(+18 dBm / tone, 1 MHz spacing)				
	900 MHz	dBm	38.0	40.0	—
	1900 MHz	dBm	38.0	40.0	—
	2140 MHz	dBm	38.0	40.0	—
Noise Figure	900 MHz	dB	—	4.5	5.7
	1900 MHz	dB	—	3.3	4.5
	2140 MHz	dB	—	3.5	4.7
Current @ 18 dBm Output	2140 MHz	mA	125	175	225

Typical Performance: $T_A = +25^\circ\text{C}$, $V_{CC} = +5\text{ V}$, $Z_0 = 50\ \Omega$

Parameter	Test Conditions	Units	900 MHz	1900 MHz	2140 MHz
Input Return Loss		dB	15	15	10
Output Return Loss		dB	15	10	12
Output P1dB		dB	27	27	27
Channel Power	-45 dBc ACPR, IS-95 9 channels fwd	dBm	20	19	—
	-45 dBc ACPR, 3GPP WCDMA	dBm	—	—	18
Quiescent Current		mA	160	160	160

Lead-Free SOT-89 Plastic Package[†]

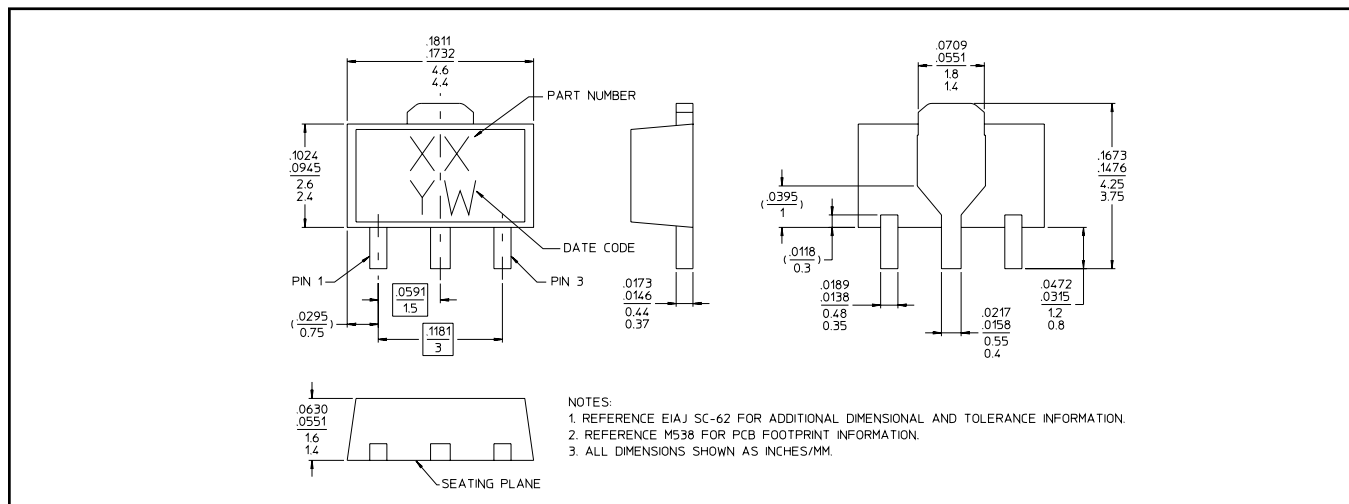

[†] Reference Application Note M538 for lead-free solder reflow recommendations.
Meets JEDEC moisture sensitivity level 1 requirements.

**RF Driver Amplifier
250 - 4000 MHz**

**MAAMSS0048
V4**

900 MHz PCB Layout

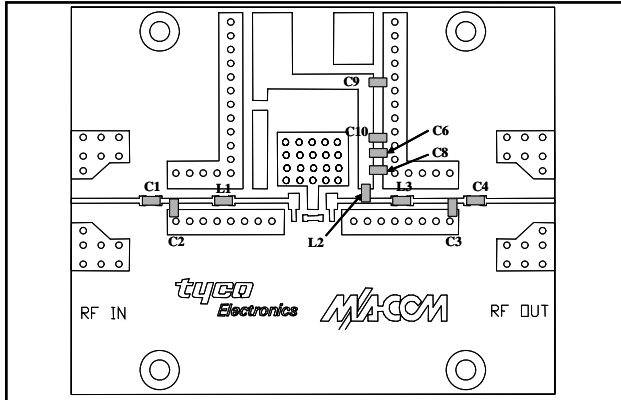

900 MHz Schematic

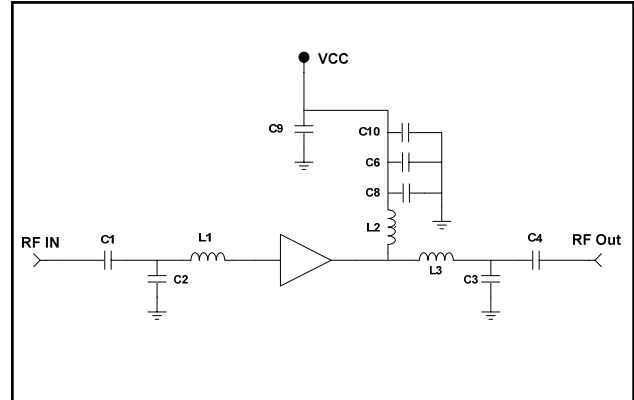

1900 MHz PCB Layout

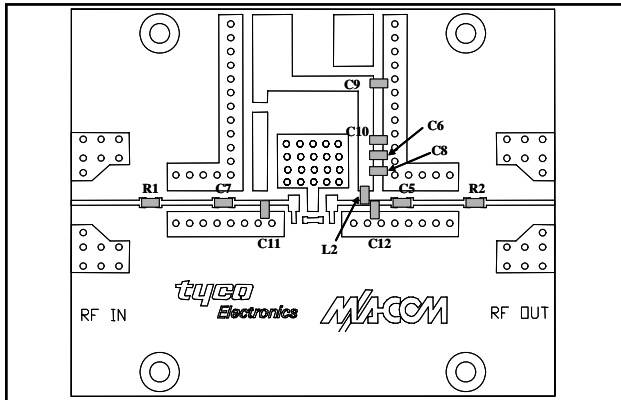

1900 MHz Schematic

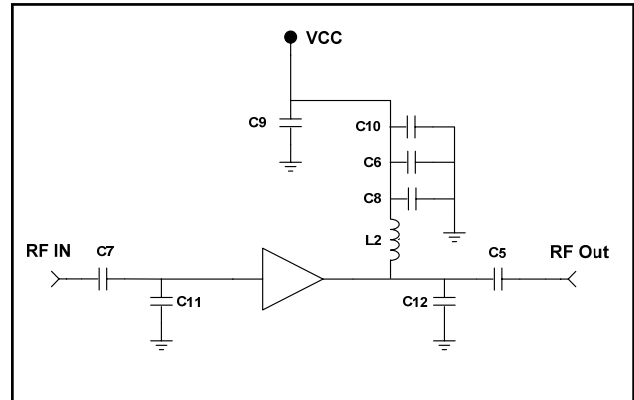

2140 MHz PCB Layout

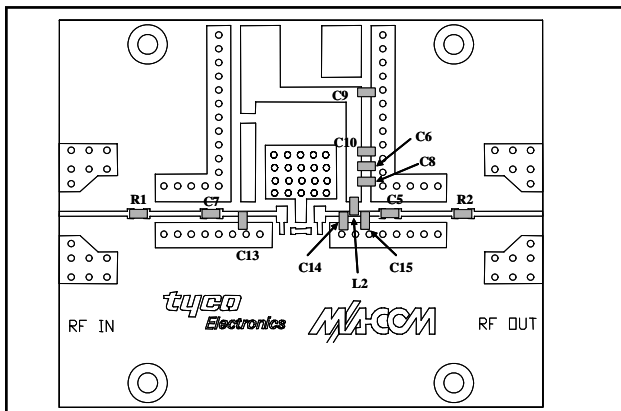

2140 MHz Schematic

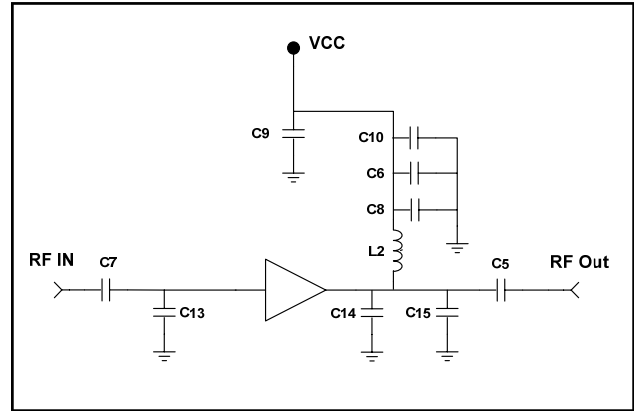

**RF Driver Amplifier
250 - 4000 MHz**

**MAAMSS0048
V4**

Parts List

Part	Value	Used on Freq. Band	Case Style	Manufacturer	Purpose
C1, C4	1000 pF	300, 900	0402	Murata	DC Block
C6	1000 pF	All	0402	Murata	DC Block / Bypass
C2	6 pF	900	0402	Murata	Input Tuning
C3	4.7 pF	900	0402	Murata	Output Tuning
C5	39 pF	1900, 2140	0402	Murata	Output Tuning & DC Block
C7	12 pF	1900, 2141	0402	Murata	Input Tuning & DC Block
C8	15 pF	All	0402	Murata	Bypass
C16, C17	15 pF	300	0402	Murata	Input & Output Tuning
C9, C10	0.1 uF	All	0402	Murata	Bypass
C11	3 pF	1900	0402	Murata	Input Tuning
C12	2.7 pF	1900	0402	Murata	Output Tuning
C13	2 pF	2140	0402	Murata	Input Tuning
C14	2.2 pF	2140	0402	Murata	Output Tuning
C15	0.5 pF	2140	0402	Murata	Output Tuning
C18	1.5 pF	2400, 2700	0402	Murata	Output Tuning
C19	1.0 pF	3500	0402	Murata	Input Tuning
C20, C21	0.8 pF	2700, 3500, 3700	0603	Murata	Input Tuning
L1	3.3 nH	900	0402	Coilcraft	Input Tuning
L2	7.5 nH	900, 1900, 2140, 2400, 2700, 3500, 3700	0402	Coilcraft	Bias Injection
L3	1 nH	900	0402	Coilcraft	Output Tuning
L4	22 nH	300	0402	Coilcraft	Bias Injection
L5	33 nH	300	0402	Coilcraft	Input Tuning
L6	9 nH	300	0402	Coilcraft	Output Tuning
R1, R2	0 W	1900, 2140	0402	Panasonic	Jumper

Cross Section View

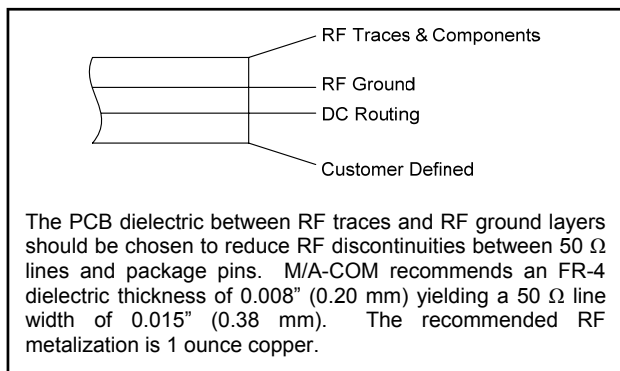

Typical Performance Curves, 900 MHz Configuration

Gain

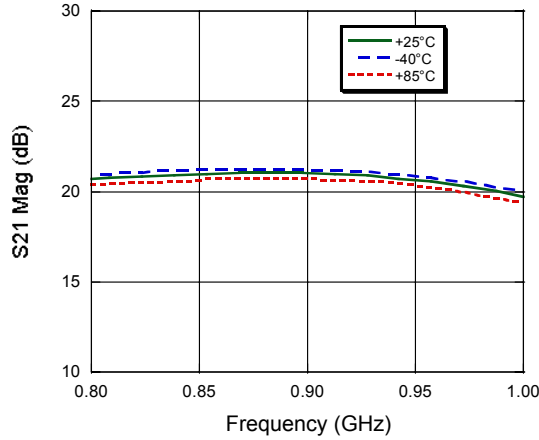

Input Return Loss

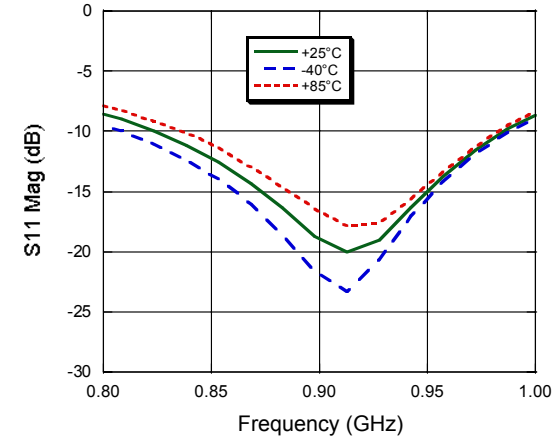

Output Return Loss

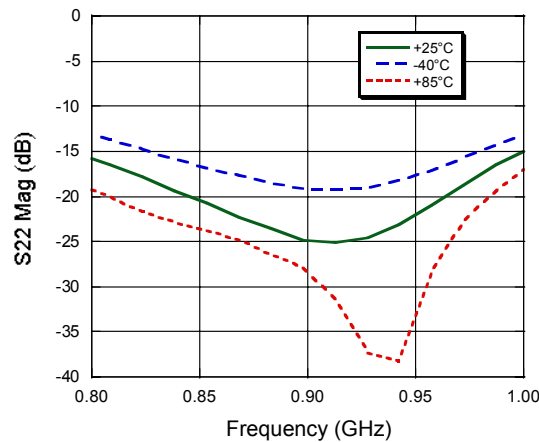

Noise Figure

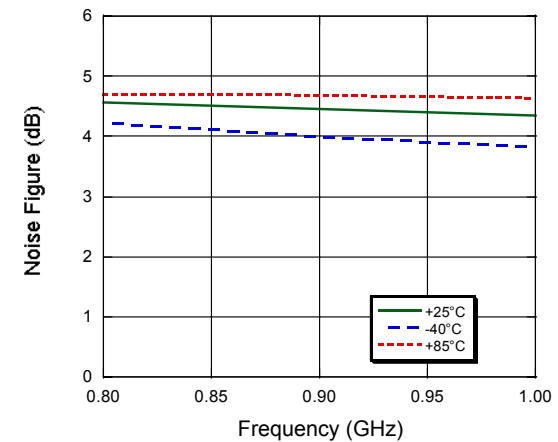

P1dB

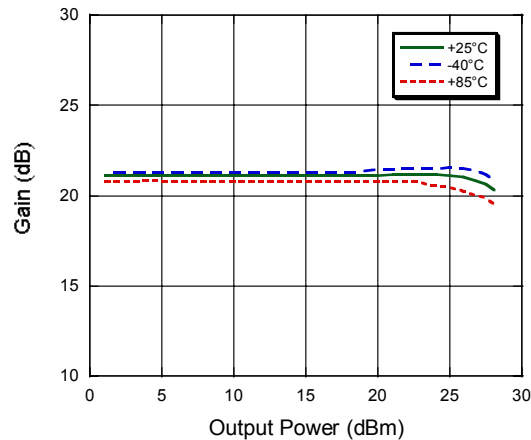

Output IP3

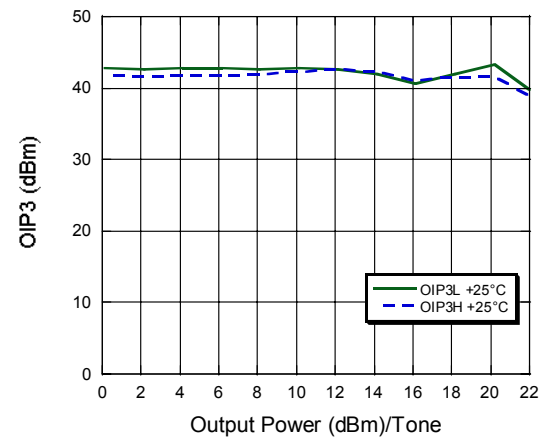

Typical Performance Curves, 1900 MHz Configuration

Gain

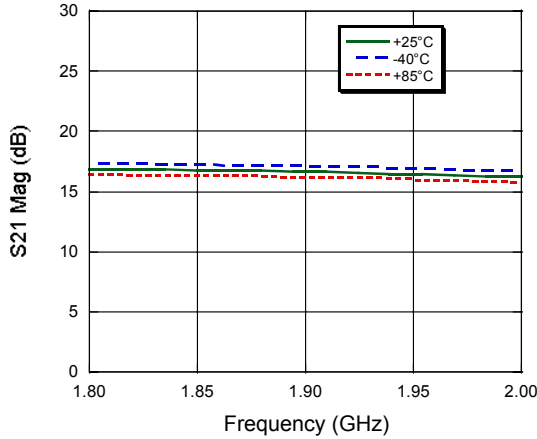

Input Return Loss

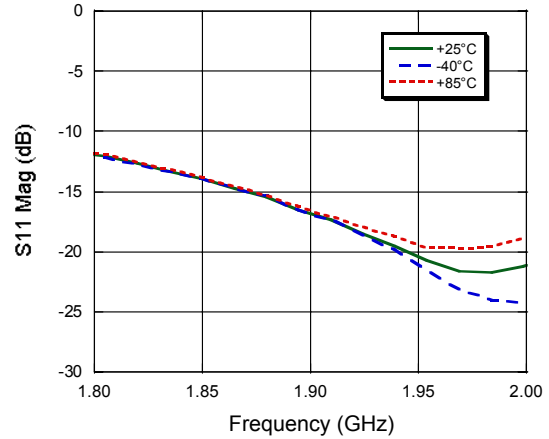

Output Return Loss

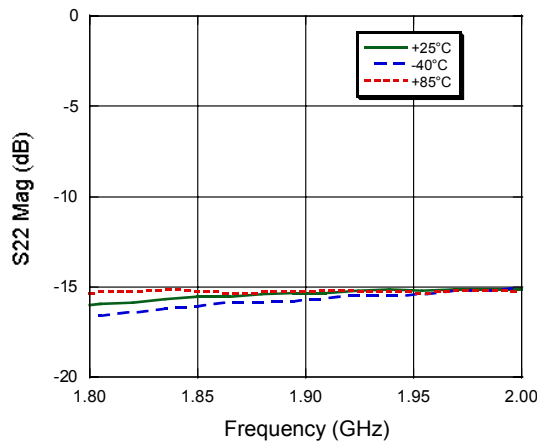

Noise Figure

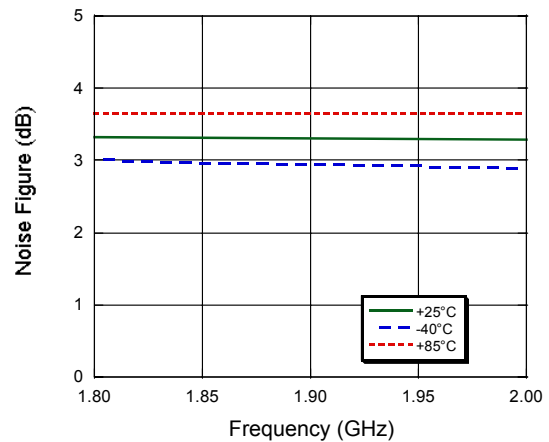

P1dB

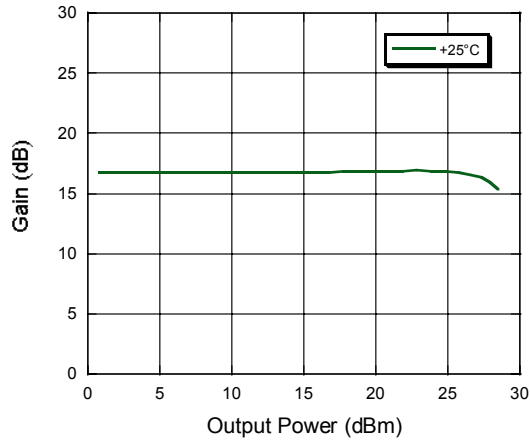

Output IP3

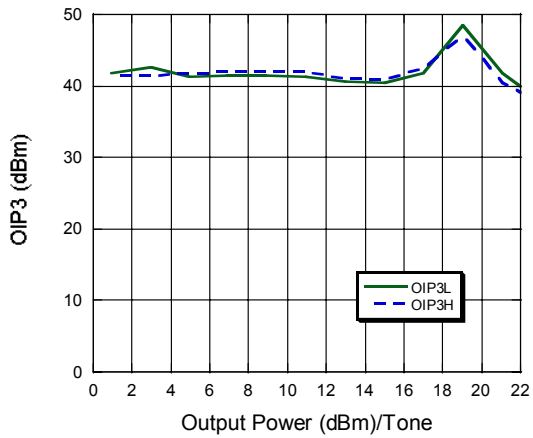

Typical Performance Curves, 2140 MHz Configuration

Gain

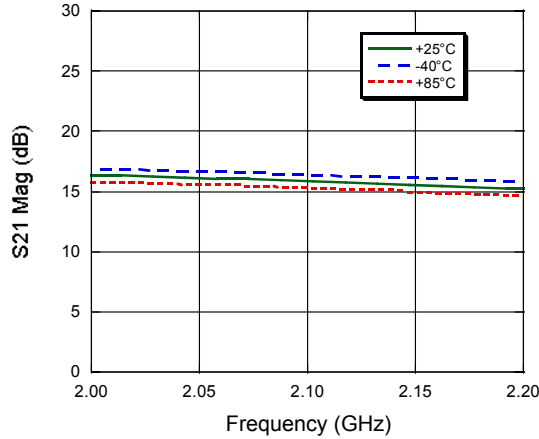

Input Return Loss

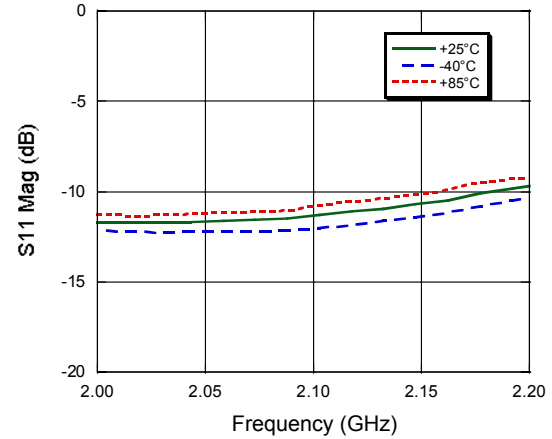

Output Return Loss

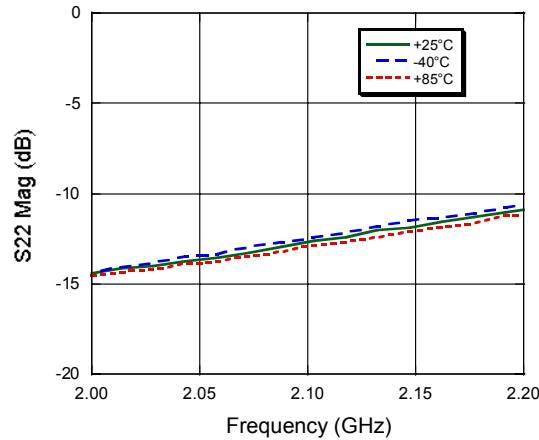

Noise Figure

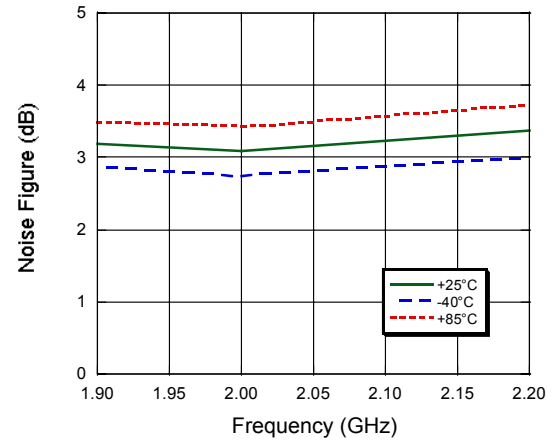

P1dB

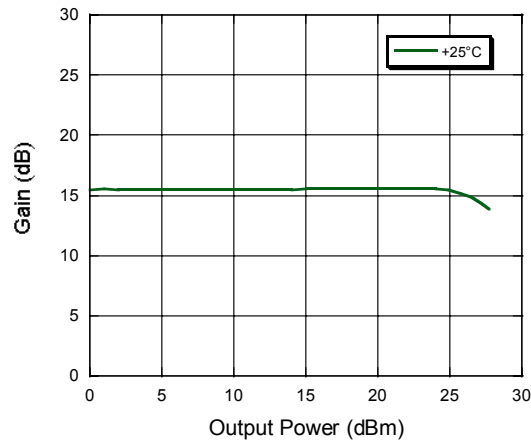

Output IP3

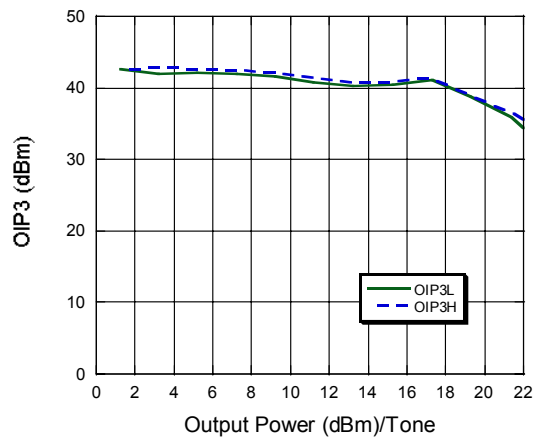

Applications Section

Typical Performance Curves, 300 MHz Configuration

Gain

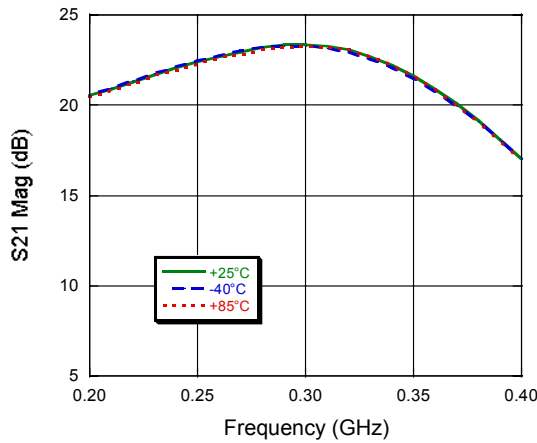

Input Return Loss

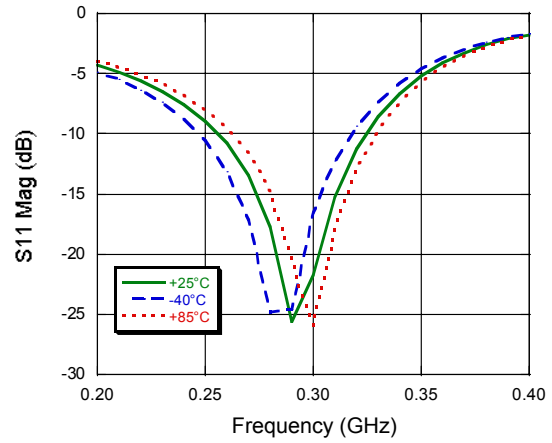

Output Return Loss

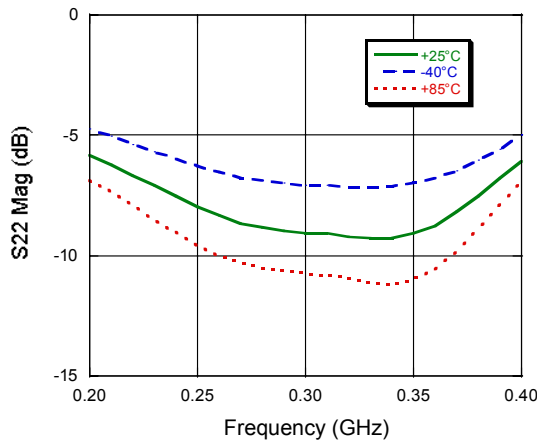

Noise Figure

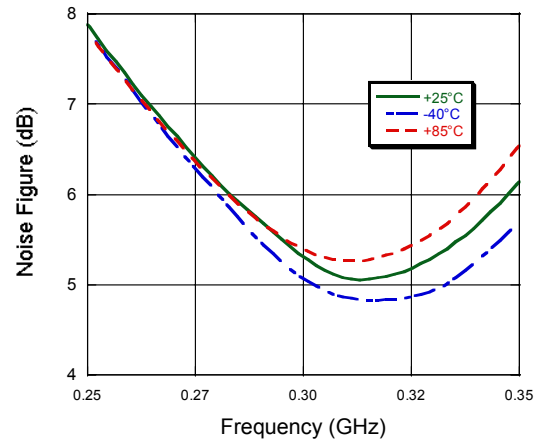

P1dB

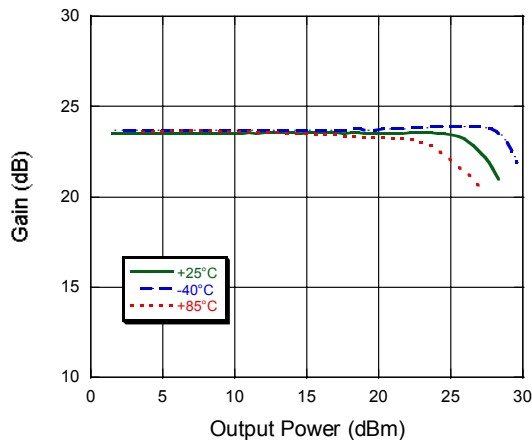

Output IP3

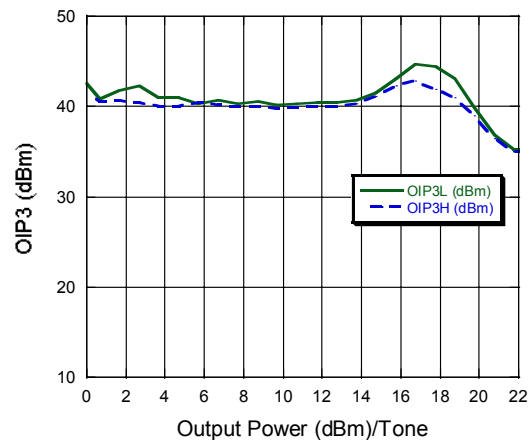

Applications Section

Typical Performance Curves, 2400 MHz Configuration

Gain

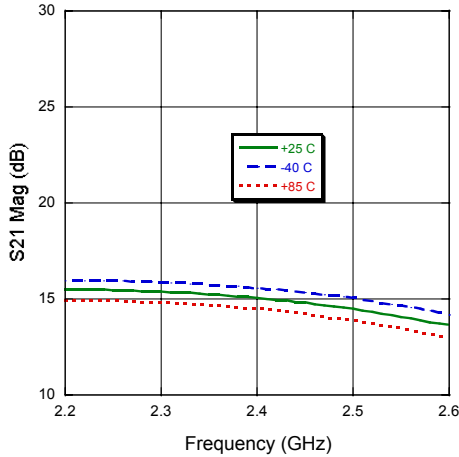

Input Return Loss

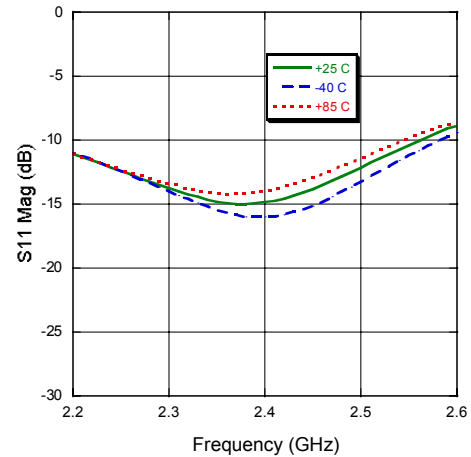

Output Return Loss

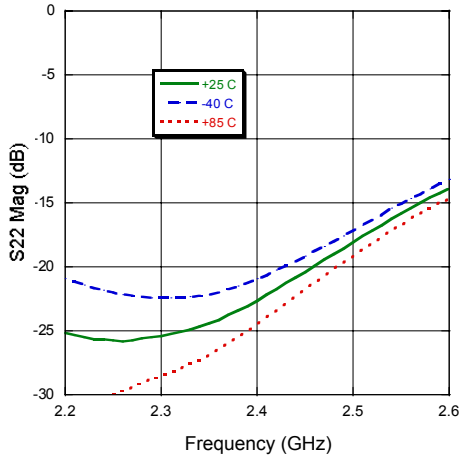

Noise Figure

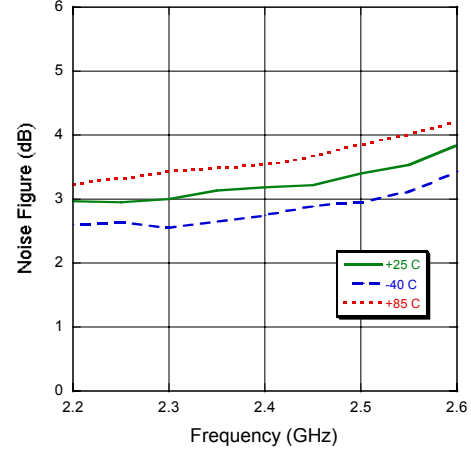

P1dB

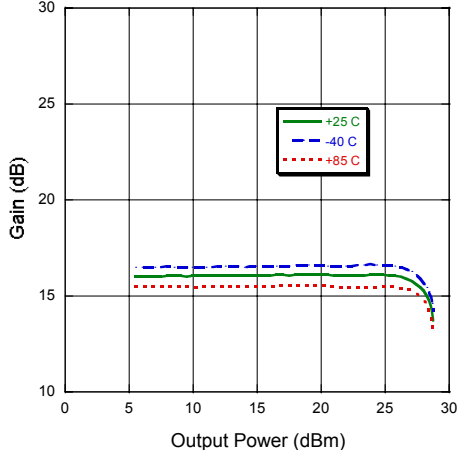

Output IP3

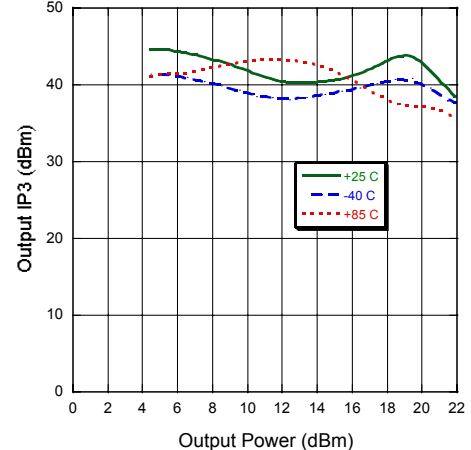

Applications Section

Typical Performance Curves, 2700 MHz Configuration

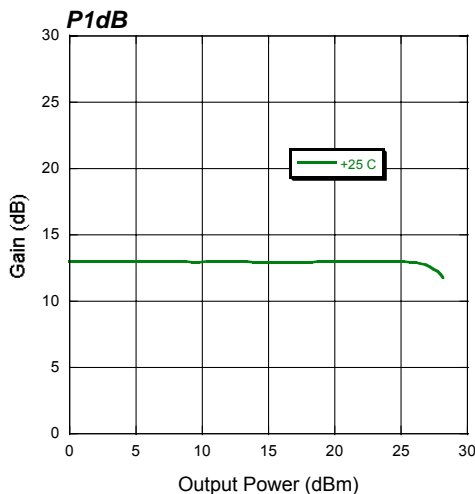
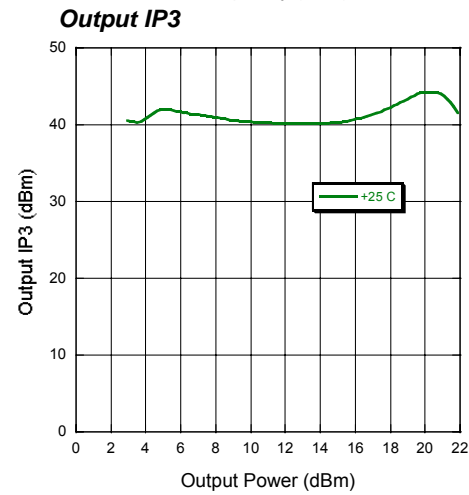
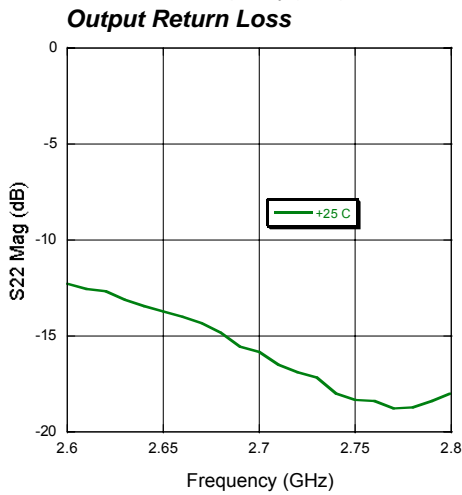
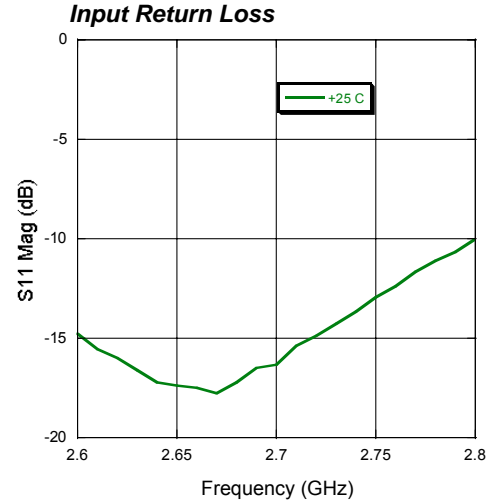
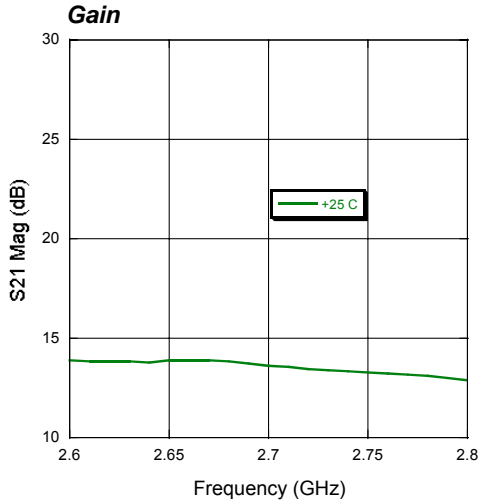

Applications Section

Typical Performance Curves, 3500 MHz Configuration

Gain

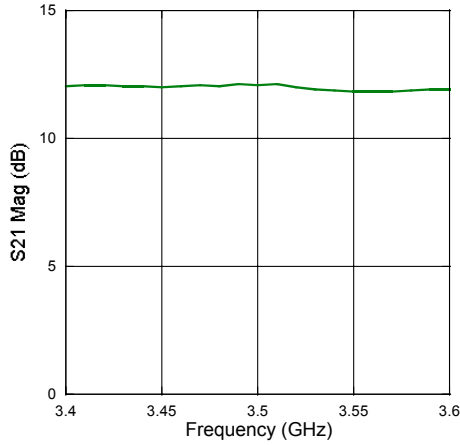

Input Return Loss

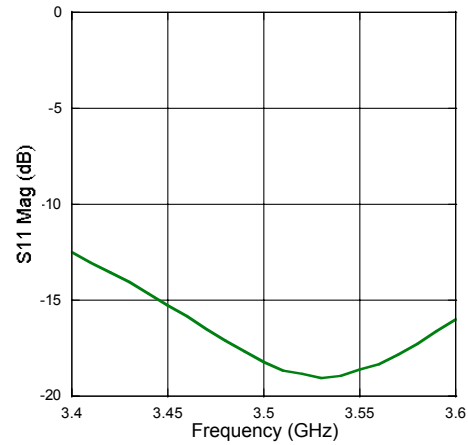

Output Return Loss

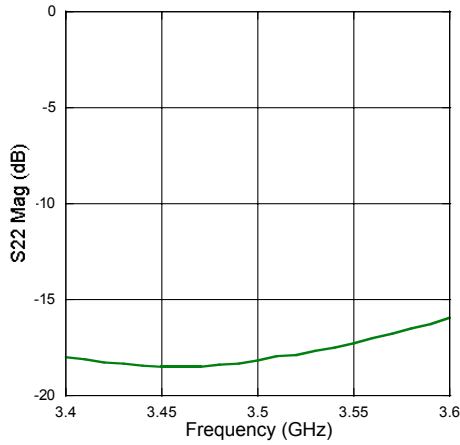

Output IP3

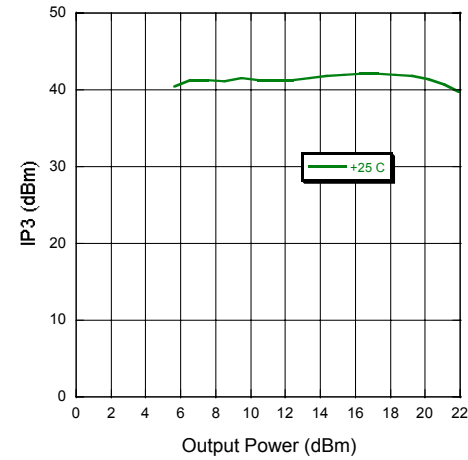

P1dB

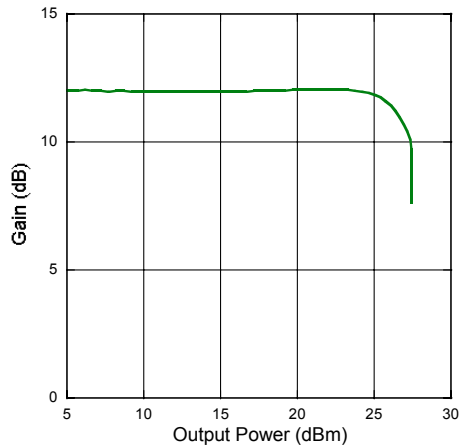

Applications Section

Typical Performance Curves, 3700 MHz Configuration

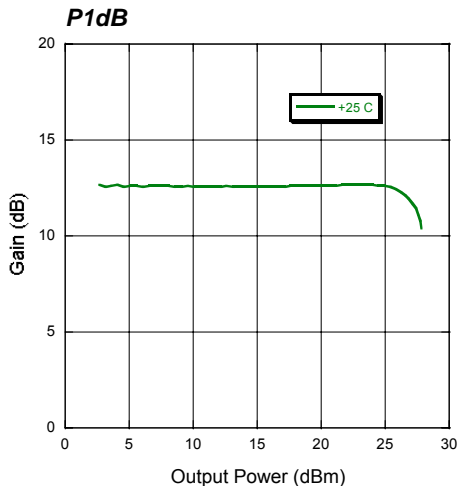
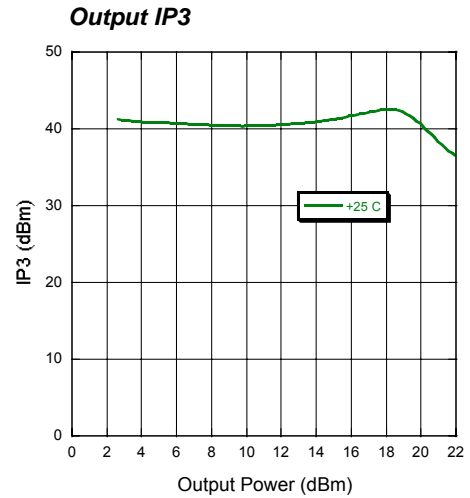
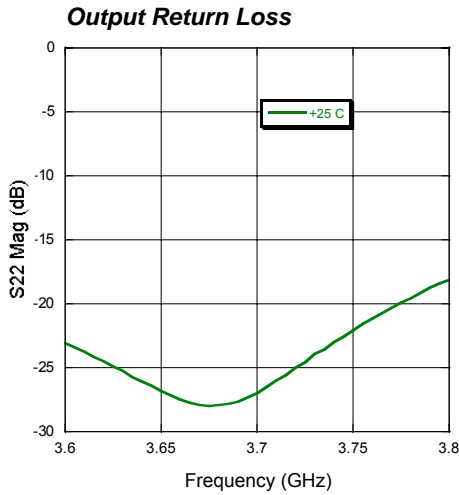
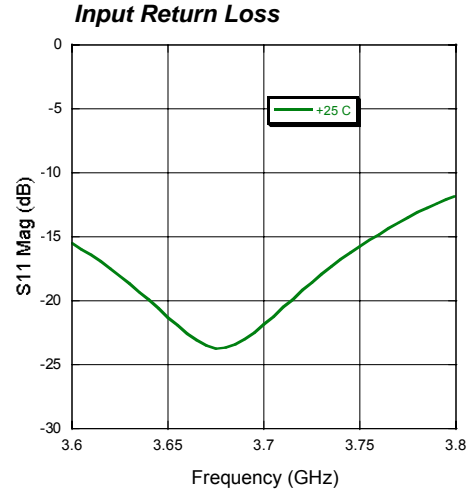
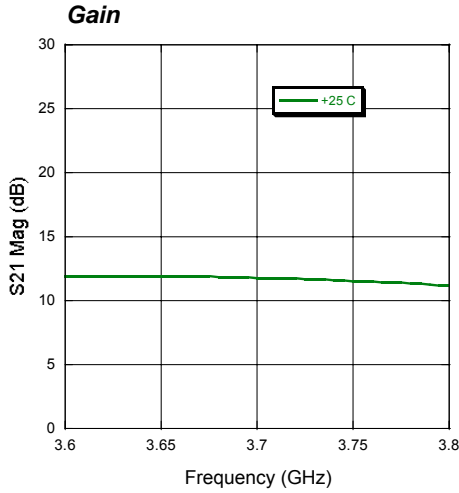

Applications Section

300 MHz PCB Layout

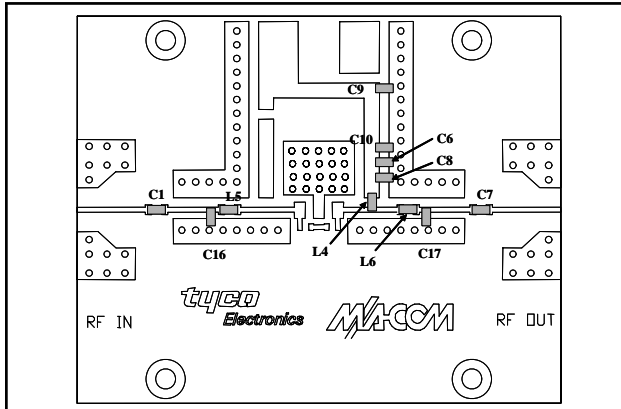

300 MHz Schematic

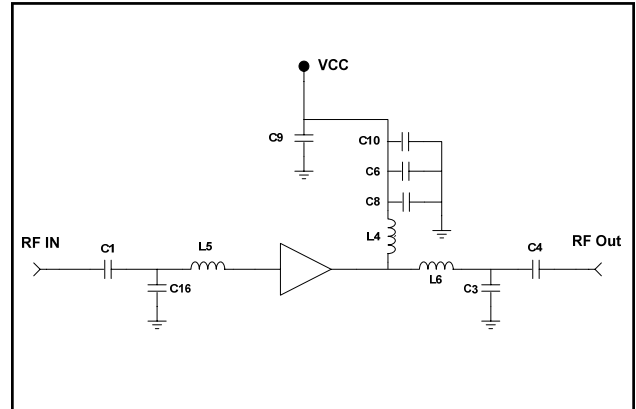

2400 MHz PCB Layout

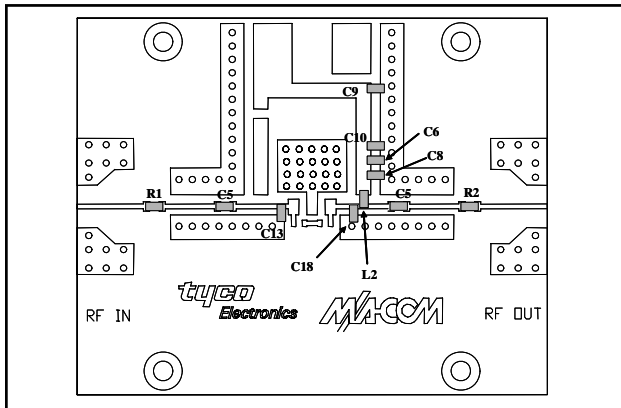

2400 MHz Schematic

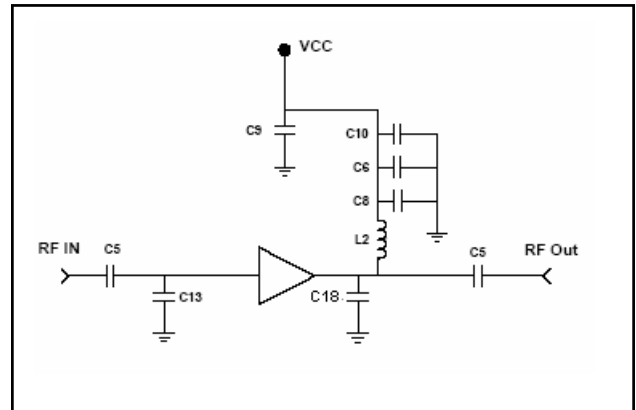

2700 MHz PCB Layout

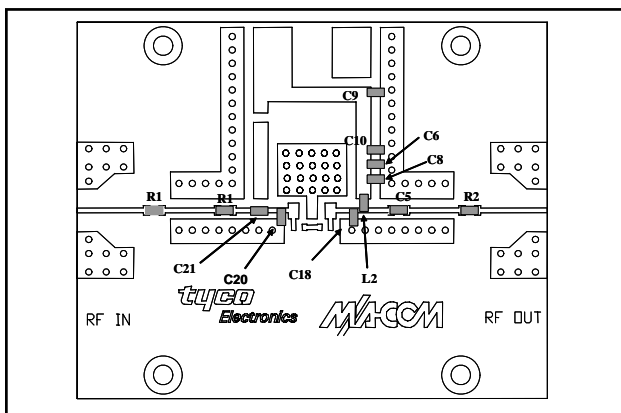

2700 MHz Schematic

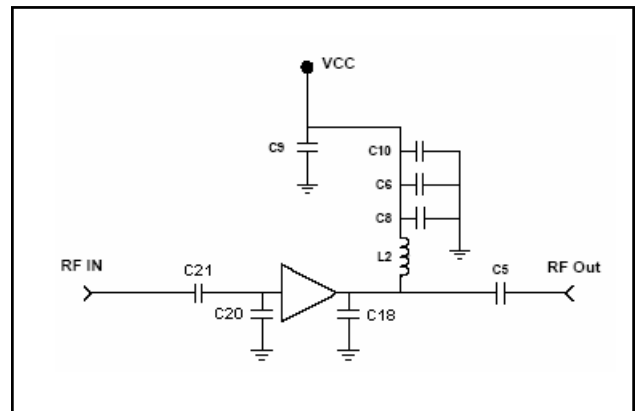

Applications Section

3500 MHz PCB Layout

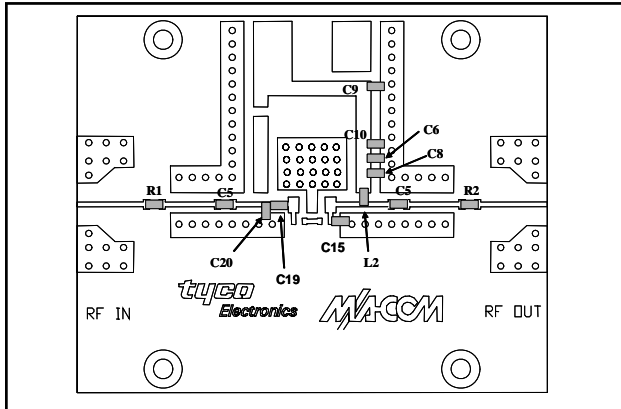

3500 MHz Schematic

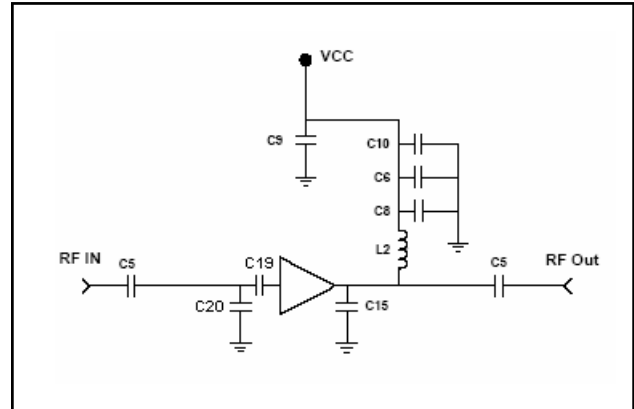

3700 MHz PCB Layout

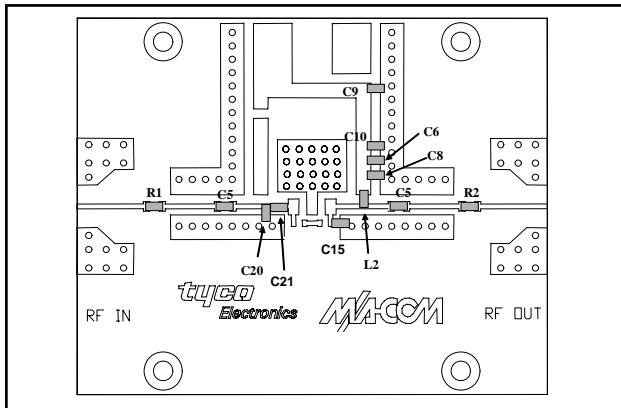

3700 MHz Schematic

