

Features

- 75 Ohm
- SMT unit
- Low Cost, Low Profile
- RoHS* Compliant

Description

M/A-COM's MAFLCT0068 is a low cost, low profile diplex filter designed for use in CATV set-top box and cable modem applications. Technology used in this design is patent pending.

Functional Schematic

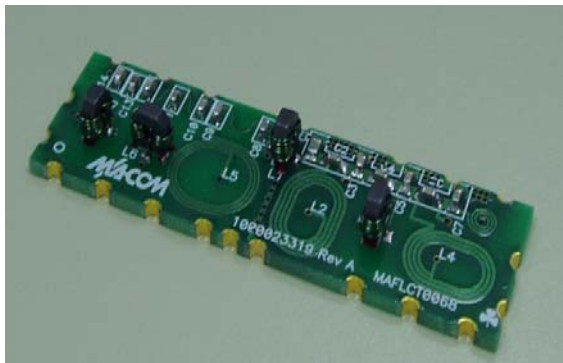
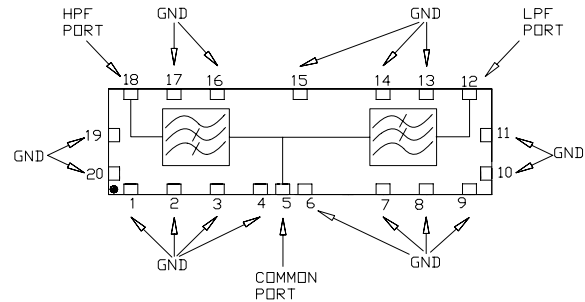

Pin Configuration

Function	Pin Number
Common Port	5
Low Pass Port	12
High Pass Port	18
Ground	1-4, 6-11, 13-17, 19,20
Not connected	-

Absolute Maximum Ratings ^{1,2}

Parameter	Absolute Maximum
RF Power	250mW
DC Current	30mA
Operating Temperature	-40°C to +85°C
Storage Temperature	-40°C to +85°C

1. Exceeding any one or combination of these limits may cause permanent damage to this device.
2. M/A-COM does not recommend sustained operation near these survivability limits.

* Restrictions on Hazardous Substances, European Union Directive 2002/95/EC.

SM-161 Case Style

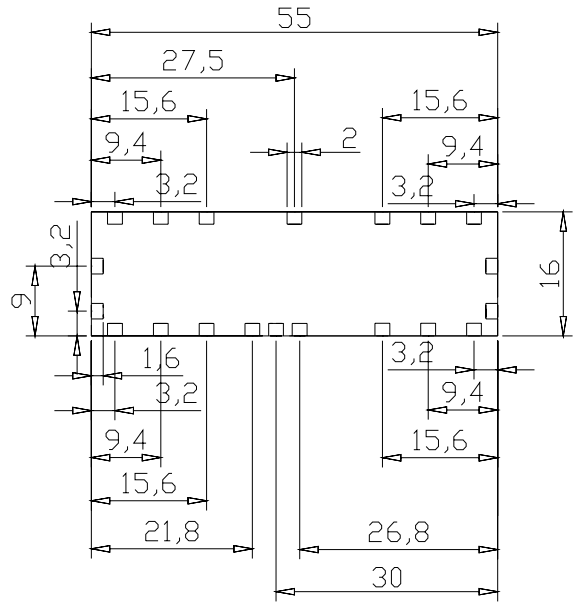
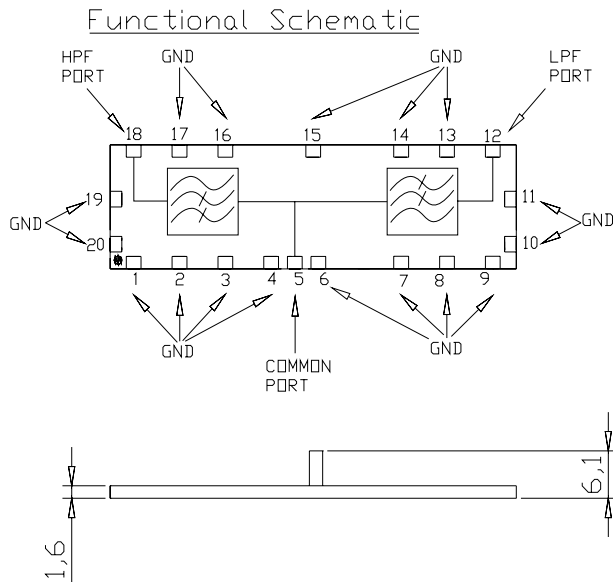

Dimensions in mm. Tolerance: .x ± 0.1, .xx ± 0.05

Recommended PCB Configuration

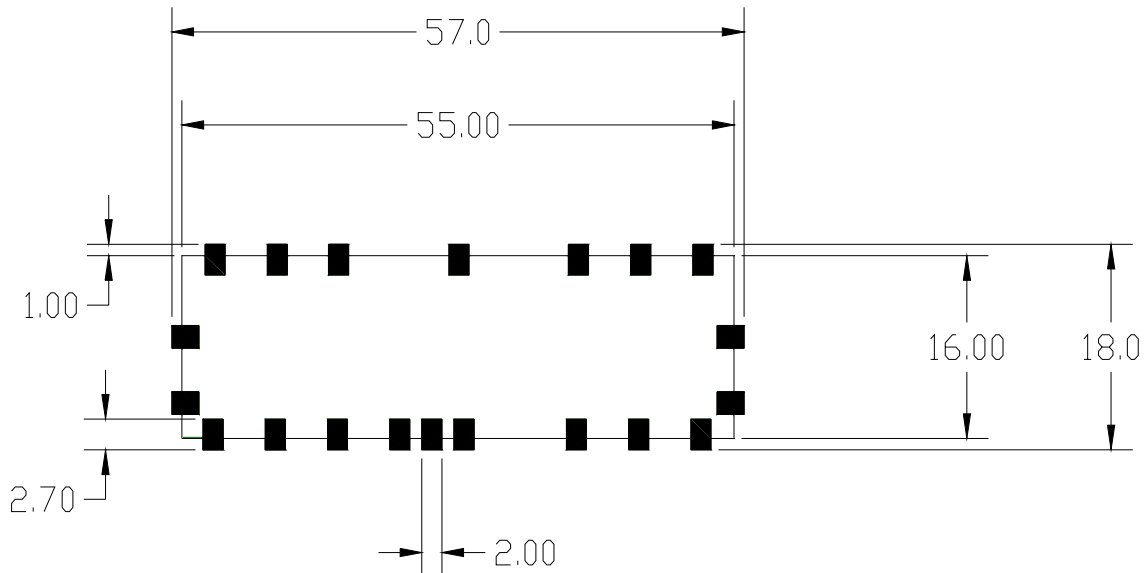

Dimensions in mm. Tolerance: .x ± 0.1, .xx ± 0.05

CATV Diplex Filter
5 - 42 / 54 - 1100MHz

MAFLCT0068
V3P

Electrical Specifications: $T_A = 25^\circ\text{C}$, $Z_0 = 75\Omega$

Parameter	Test Conditions	Units	Min	Typ	Max
Frequency Range:	5 - 42MHz / 54 - 1100MHz				
Low Pass Filter Insertion Loss:	5 - 36MHz	dB			-1.1
	36 - 42MHz	dB			-1.2
High Pass Filter Insertion Loss:	54 - 56.5MHz	dB			-1.3
	56.5 - 1100MHz	dB			-1.2
Filter Isolation:	5 - 36MHz	dB	-55		
	36 - 42MHz	dB	-53		
Filter Isolation:	54 - 60MHz	dB	-53		
	60 - 200MHz	dB	-55		
	200 - 860MHz	dB	-50		
	860 - 1100MHz	dB	-45		
Input Return Loss:	5 - 42MHz	dB	-12		
Input Return Loss:	54 - 860MHz	dB	-12		
	860 - 1100MHz	dB	-10		
Input Port Voltage Transient		V			200

Typical Performance Curves

Input Return Loss

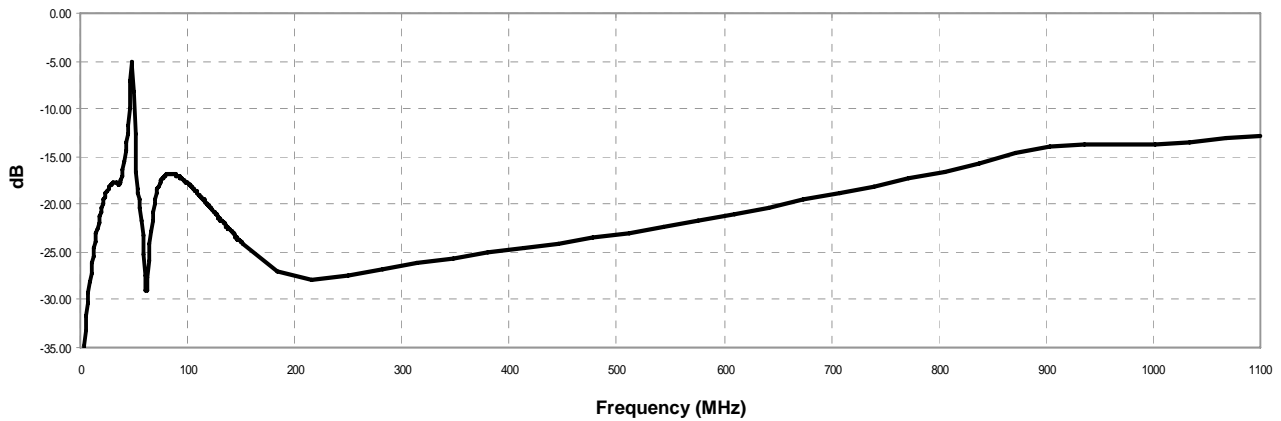

Low Pass Filter Insertion loss

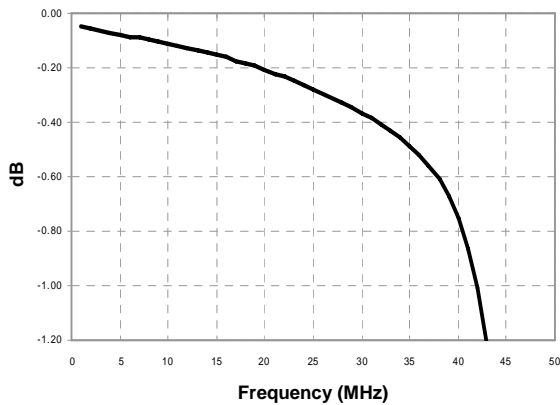

High Pass Filter Insertion loss

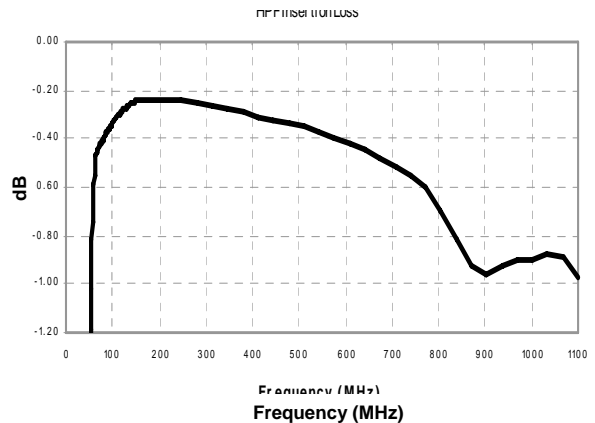

Filter Insertion Loss

