

MBRA120ET3

Surface Mount Schottky Power Rectifier

SMA Power Surface Mount Package

... employing the Schottky Barrier principle in a metal-to-silicon power rectifier. Features epitaxial construction with oxide passivation and metal overlay contact. Ideally suited for low voltage, high frequency switching power supplies; free wheeling diodes and polarity protection diodes.

- Compact Package with J-Bend Leads Ideal for Automated Handling
- Highly Stable Oxide Passivated Junction
- Guardring for Over-Voltage Protection
- Optimized for Low Leakage Current

Mechanical Characteristics:

- Case: Molded Epoxy
- Epoxy Meets UL94, V_O at 1/8"
- Weight: 70 mg (approximately)
- Finish: All External Surfaces Corrosion Resistant and Terminal Leads are Readily Solderable
- Lead and Mounting Surface Temperature for Soldering Purposes: 260°C Max. for 10 Seconds
- Polarity: Polarity Band Indicates Cathode Lead
- Available in 12 mm Tape, 5000 Units per 13 inch Reel
- Device Meets MSL1 Requirements
- ESD Ratings: Machine Model, C (>400 V)
Human Body Model, 3B (>8000 V)
- Marking: B1E2

MAXIMUM RATINGS

Rating	Symbol	Value	Unit
Peak Repetitive Reverse Voltage Working Peak Reverse Voltage DC Blocking Voltage	V _{RRM} V _{RWM} V _R	20	V
Average Rectified Forward Current (At Rated V _R , T _C = 125°C)	I _O	1.0	A
Non-Repetitive Peak Surge Current (Surge Applied at Rated Load Conditions Halfwave, Single Phase, 60 Hz)	I _{FSM}	40	A
Storage Temperature	T _{stg}	-55 to +150	°C
Operating Junction Temperature	T _J	-55 to +150	°C
Voltage Rate of Change (Rated V _R , T _J = 25°C)	dv/dt	10,000	V/μs



ON Semiconductor®

<http://onsemi.com>

**SCHOTTKY BARRIER
RECTIFIER
1 AMPERE
20 VOLTS**



**SMA
CASE 403D
PLASTIC**

**MARKING
DIAGRAM**



B1E2 = Device Code

ORDERING INFORMATION

Device	Package	Shipping†
MBRA120ET3	SMA	5000/Tape & Reel

†For information on tape and reel specifications, including part orientation and tape sizes, please refer to our Tape and Reel Packaging Specification Brochure, BRD8011/D.

MBRA120ET3

THERMAL CHARACTERISTICS

Characteristic	Symbol	5 mm x 5 mm (Note 2)	1 Inch x 1/2 inch (Note 3)	Unit
Thermal Resistance – Junction–to–Lead	$R_{\theta JL}$	34	20	$^{\circ}C/W$
Thermal Resistance – Junction–to–Ambient	$R_{\theta JA}$	138	77	

ELECTRICAL CHARACTERISTICS

Maximum Instantaneous Forward Voltage (Note 1), See Figure 2 ($I_F = 0.1$ A) ($I_F = 1.0$ A) ($I_F = 2.0$ A)	V_F	$T_J = 25^{\circ}C$	$T_J = 100^{\circ}C$	V
		0.455	0.360	
		0.530	0.455	
Maximum Instantaneous Reverse Current, See Figure 4 ($V_R = 20$ V) ($V_R = 10$ V) ($V_R = 5.0$ V)	I_R	$T_J = 25^{\circ}C$	$T_J = 100^{\circ}C$	μA
		10	1600	
		1.0	500	
		0.5	300	

1. Pulse Test: Pulse Width ≤ 250 μs , Duty Cycle $\leq 2\%$.
2. Mounted on a Pad Size of 5 mm x 5 mm, PC Board FR4 (2 pads).
3. Mounted on a Pad Size of 1 inch x 1/2 inch, PC Board FR4 (2 pads).

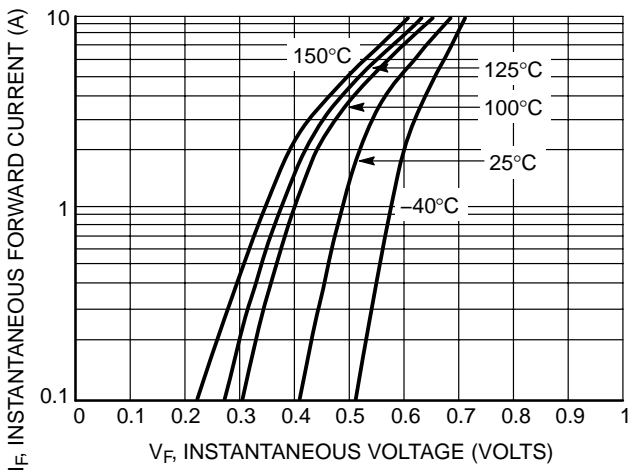

Figure 1. Typical Forward Voltage

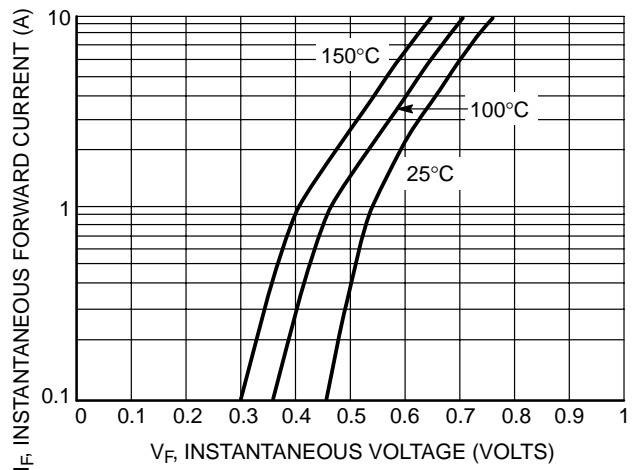

Figure 2. Maximum Forward Voltage

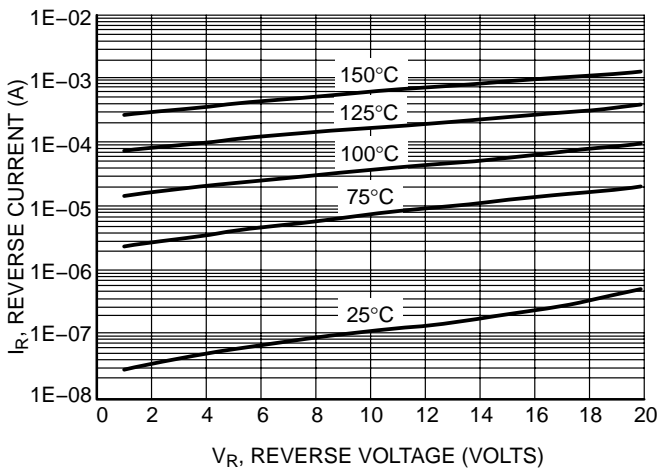

Figure 3. Typical Reverse Current

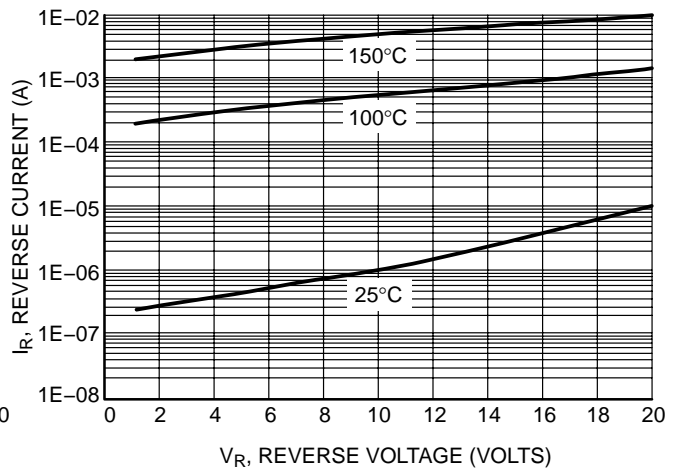

Figure 4. Maximum Reverse Current

MBRA120ET3

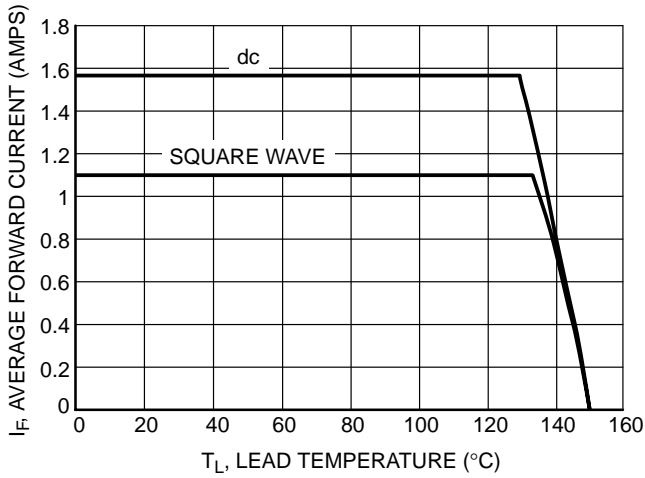

Figure 5. Current Derating

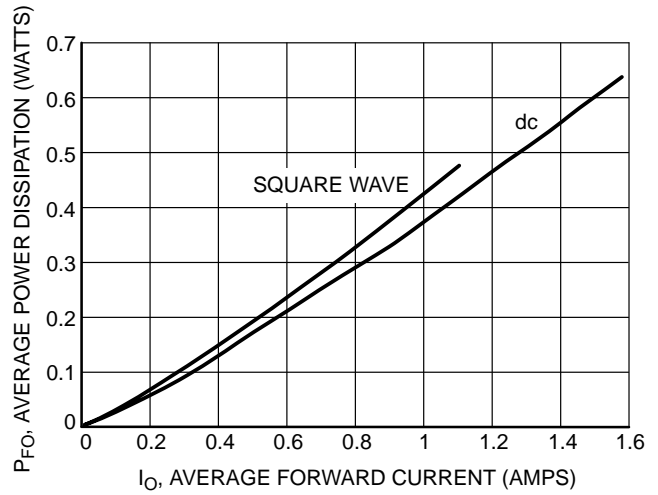

Figure 6. Forward Power Dissipation

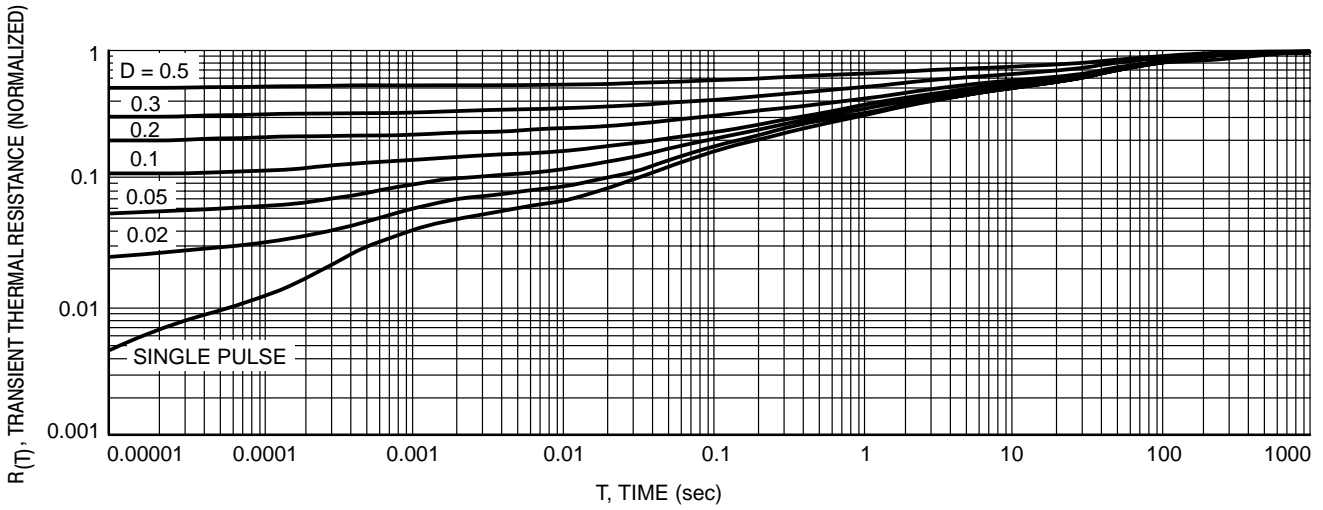

Figure 7. Thermal Resistance

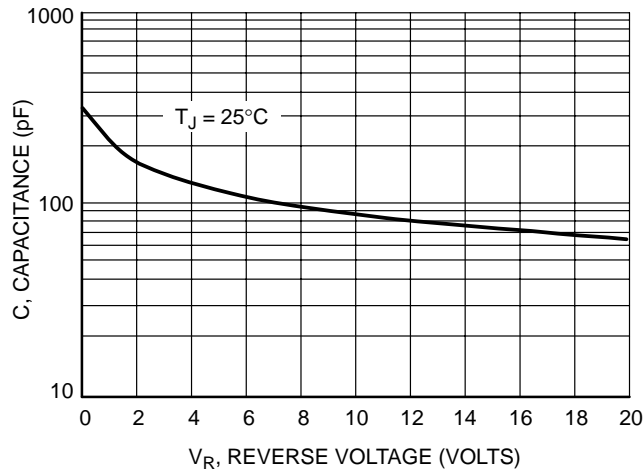
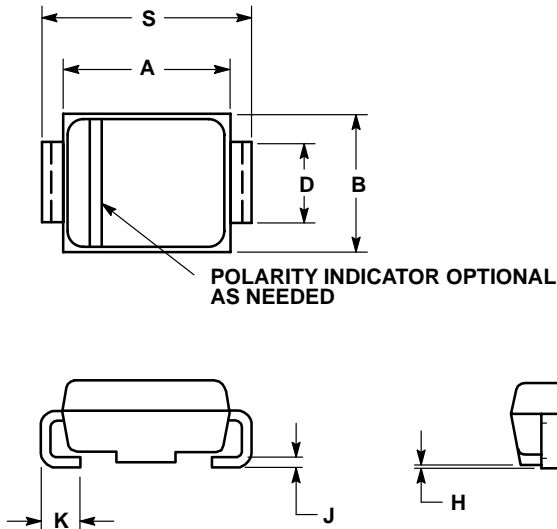

Figure 8. Typical Junction Capacitance

MBRA120ET3

PACKAGE DIMENSIONS

SMA
CASE 403D-02
ISSUE A



- NOTES:
1. DIMENSIONING AND TOLERANCING PER ANSI Y14.5M, 1982.
 2. CONTROLLING DIMENSION: INCH.
 3. 403D-01 OBSOLETE, NEW STANDARD IS 403D-02.

DIM	INCHES		MILLIMETERS	
	MIN	MAX	MIN	MAX
A	0.160	0.180	4.06	4.57
B	0.090	0.115	2.29	2.92
C	0.075	0.095	1.91	2.41
D	0.050	0.064	1.27	1.63
H	0.002	0.006	0.05	0.15
J	0.006	0.016	0.15	0.41
K	0.030	0.060	0.76	1.52
S	0.190	0.220	4.83	5.59

SOLDERING FOOTPRINT*

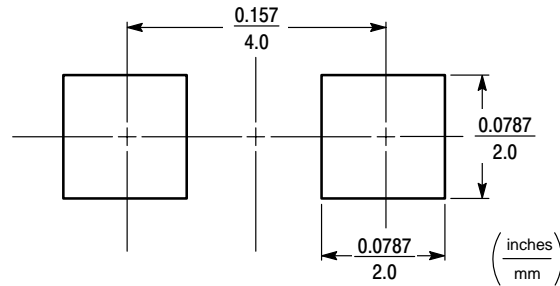

SMA FOOTPRINT

*For additional information on our Pb-Free strategy and soldering details, please download the ON Semiconductor Soldering and Mounting Techniques Reference Manual, SOLDERRM/D.

ON Semiconductor and  are registered trademarks of Semiconductor Components Industries, LLC (SCILLC). SCILLC reserves the right to make changes without further notice to any products herein. SCILLC makes no warranty, representation or guarantee regarding the suitability of its products for any particular purpose, nor does SCILLC assume any liability arising out of the application or use of any product or circuit, and specifically disclaims any and all liability, including without limitation special, consequential or incidental damages. "Typical" parameters which may be provided in SCILLC data sheets and/or specifications can and do vary in different applications and actual performance may vary over time. All operating parameters, including "Typicals" must be validated for each customer application by customer's technical experts. SCILLC does not convey any license under its patent rights nor the rights of others. SCILLC products are not designed, intended, or authorized for use as components in systems intended for surgical implant into the body, or other applications intended to support or sustain life, or for any other application in which the failure of the SCILLC product could create a situation where personal injury or death may occur. Should Buyer purchase or use SCILLC products for any such unintended or unauthorized application, Buyer shall indemnify and hold SCILLC and its officers, employees, subsidiaries, affiliates, and distributors harmless against all claims, costs, damages, and expenses, and reasonable attorney fees arising out of, directly or indirectly, any claim of personal injury or death associated with such unintended or unauthorized use, even if such claim alleges that SCILLC was negligent regarding the design or manufacture of the part. SCILLC is an Equal Opportunity/Affirmative Action Employer. This literature is subject to all applicable copyright laws and is not for resale in any manner.

PUBLICATION ORDERING INFORMATION

LITERATURE FULFILLMENT:
Literature Distribution Center for ON Semiconductor
P.O. Box 5163, Denver, Colorado 80217 USA
Phone: 303-675-2175 or 800-344-3860 Toll Free USA/Canada
Fax: 303-675-2176 or 800-344-3867 Toll Free USA/Canada
Email: orderlit@onsemi.com

N. American Technical Support: 800-282-9855 Toll Free USA/Canada

Japan: ON Semiconductor, Japan Customer Focus Center
2-9-1 Kamimeguro, Meguro-ku, Tokyo, Japan 153-0051
Phone: 81-3-5773-3850

ON Semiconductor Website: <http://onsemi.com>

Order Literature: <http://www.onsemi.com/litorder>

For additional information, please contact your local Sales Representative.