

DESCRIPTION

MGB36C is high efficiency green LED lamp encapsulated in a 3mm diameter green transparent lens.

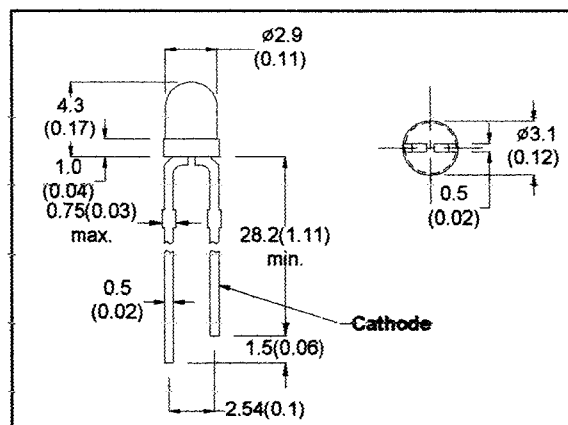

- All Dimension in mm (inch)
- No Scale
- Tol: +/- 0.3mm

ABSOLUTE MAXIMUM RATINGS

Power Dissipation @ Ta=25°C	90mW
Forward Current, DC (IF)	30mA
Reverse Voltage	5V
Operating & Storage Temperature Range	-55 to +100°C
Lead Soldering Temperature (1/16" from body)	260°C for 5 sec.

ELECTRO-OPTICAL CHARACTERISTICS (Ta=25°C)

PARAMETER	SYMBOL	MIN	TYP	MAX	UNIT	CONDITIONS
Forward Voltage	VF		2.2	3.0	V	IF=20mA
Reverse Breakdown Voltage	BVR	5			V	IR=100μA
Luminous Intensity	IV	30	65		mcd	IF=20mA
Peak Wavelength	λp		570		nm	IF=20mA
Spectral Line Half Width	Δλ		30		nm	IF=20mA
Viewing Angle	2θ 1/2		52		degree	IF=20mA

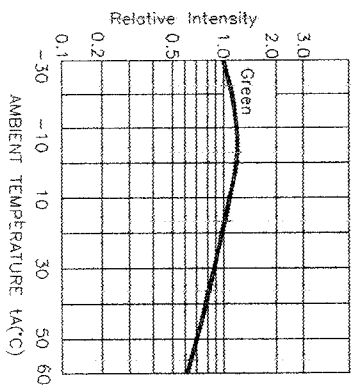
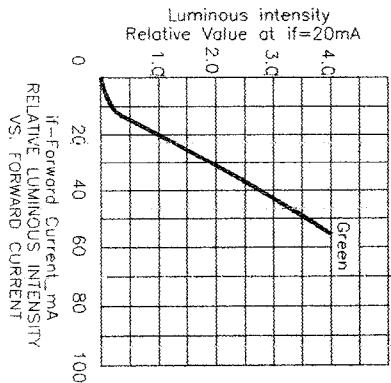
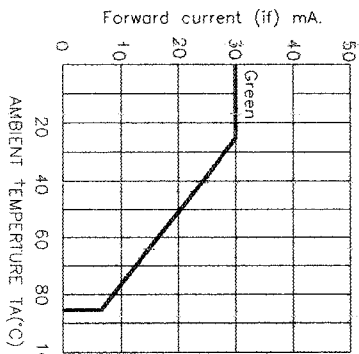
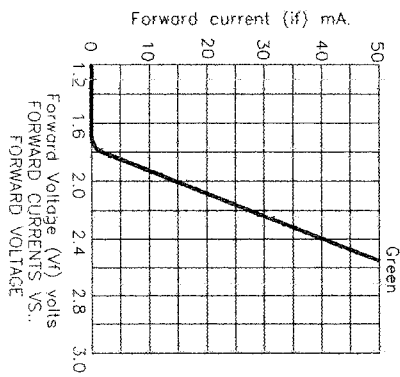
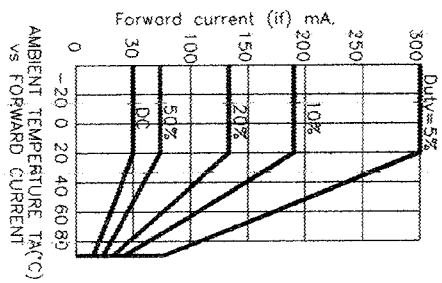
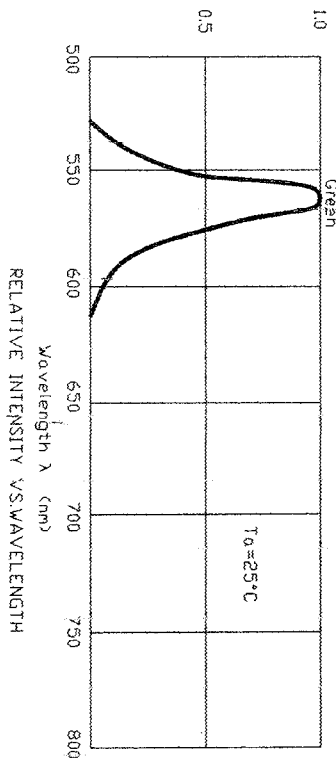
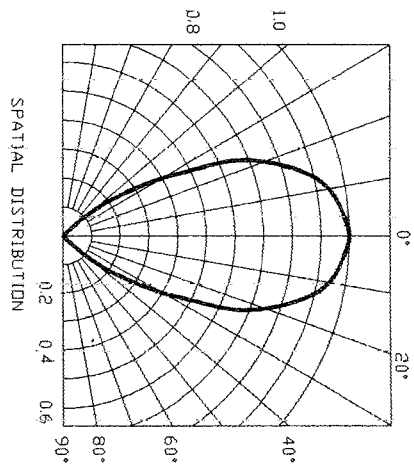

MGB36C