

General Description

The Micrel MIC2245 is a high efficiency 4MHz pulse width modulated (PWM) synchronous buck (step-down) regulator that features a *LOWQ™* LDO standby mode that draws only 18µA of quiescent current. The MIC2245 allows an ultra-low noise, small size, and high efficiency solution for portable power applications.

In PWM mode, the MIC2245 operates with a constant frequency 4MHz PWM control. Under light load conditions, such as in system sleep or standby modes, the PWM switching operation can be disabled to reduce switching losses. In this light load *LOWQ™* mode, the LDO maintains the output voltage and draws only 18µA of quiescent current. The LDO mode of operation saves battery life while not introducing spurious noise and high ripple as experienced with pulse skipping or bursting mode regulators.

The MIC2245 operates from a 2.7V to 5.5V input voltage and features internal power MOSFETs that can supply up to 500mA output current in PWM mode. It can operate with a maximum duty cycle of 100% for use in low-dropout conditions.

The MIC2245 is available in the 10-pin 3mm x 3mm MLF™ package with a junction operating range from -40°C to +125°C.

Data sheet and support documentation can be found on Micrel's web site at: www.micrel.com.

Features

- 2.7 to 5.5V supply/input voltage
- Light load *LOWQ™* LDO mode
 - 20µA quiescent current
 - Low noise, 75µVrms
- 4MHz PWM mode
 - Output current to 500mA
 - >92% efficiency
 - 100% maximum duty cycle
- Adjustable output voltage option down to 1V
 - Fixed output voltage options available
- Ultra-fast transient response
- **Uses a tiny 1µH inductor**
- Fully integrated MOSFET switches
- Micropower shutdown operation
- Thermal shutdown and current limit protection
- Pb-free 10-pin 3mm x 3mm MLF™ package
- -40°C to +125°C junction temperature range

Applications

- Cellular phones
- PDAs
- USB peripherals

Typical Application

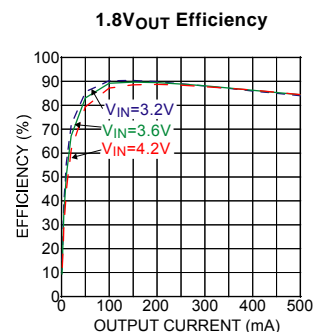
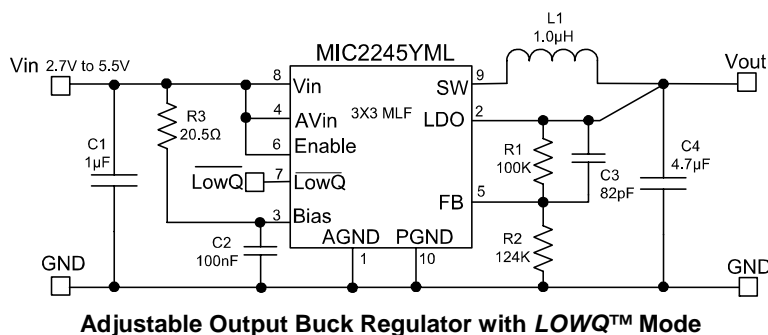

Patent Pending
LOWQ is a trademark of Micrel, Inc
 MLF and *MicroLeadFrame* are trademarks of Amkor Technology, Inc

Micrel, Inc • 2180 Fortune Drive • San Jose, Ca 95131 • USA • tel +1 (408) 944-0800 • fax +1 (408) 474-1000 • <http://www.micrel.com>

January 2006

M9999-012406

www.micrel.com

Ordering Information

Part Number	Output Voltage*	Junction Temperature Range	Package	Lead Finish
MIC2245YML	Adj.	-40° to +125°C	10-Pin 3x3 MLF™	Pb-free

Note:

* Other Voltage options available. Contact Micrel for details.

Pin Configuration

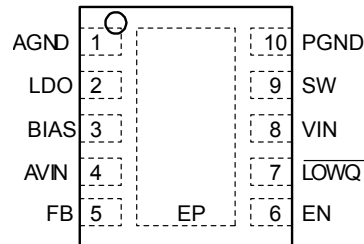

10-Pin 3mm x 3mm MLF (ML)

Pin Description

Pin Number	Pin Name	Pin Function
1	AGND	Analog (signal) Ground.
2	LDO	LDO Output (Output): Connect to V_{OUT} for LDO mode operation.
3	BIAS	Internal circuit bias supply. Must be filtered from input voltage through an RC lowpass filter with a cutoff frequency $\geq \frac{1}{2\pi(20.5\Omega)(100nF)}$.
4	AVIN	Analog Supply/Input Voltage (Input): Supply voltage for the analog control circuitry and LDO input power. Requires bypass capacitor to GND.
5	FB	Feedback. Input to the error amplifier. For the Adjustable option, connect to the external resistor divider network to set the output voltage. For fixed output voltage options, connect to V_{OUT} and an internal resistor network sets the output voltage.
6	EN	Enable (Input). Logic low will shut down the device, reducing the quiescent current to less than 5 μ A.
7	\overline{LOWQ}	Enable LDO Mode (Input): Logic low enables the internal LDO and disables the PWM operation. Logic high enables the PWM mode and disables the LDO mode.
8	VIN	Supply/Input Voltage (Input): Supply voltage for the internal switches and drivers.
9	SW	Switch (Output): Internal power MOSFET output switches.
10	PGND	Power Ground.
EP	GND	Ground, backside pad.

Absolute Maximum Ratings⁽¹⁾

Supply Voltage (V_{IN})	+6V
Output Switch Voltage (V_{SW})	+6V
Output Switch Current (I_{SW})	2A
Logic Input Voltage (V_{EN}, V_{LOWQ})	-0.3V to V_{IN}
Storage Temperature (T_s)	-60°C to +150°C
ESD Rating ⁽³⁾	3kV

Operating Ratings⁽²⁾

Supply Voltage (V_{IN})	+2.7V to +5.5V
Logic Input Voltage (V_{EN}, V_{LOWQ})	-0.3V to V_{IN}
Junction Temperature (T_J)	-40°C to +125°C
Junction Thermal Resistance 3x3 MLF-10L (θ_{JA})	60°C/W

Electrical Characteristics⁽⁴⁾

$V_{IN} = V_{EN} = V_{LOWQ} = 3.6V$; $L = 1.0\mu H$; $C_{OUT} = 4.7\mu F$; $T_A = 25^\circ C$, unless noted. **Bold** values indicate $-40^\circ C \leq T_J \leq +125^\circ C$

Parameter	Condition	Min	Typ	Max	Units
Supply Voltage Range		2.7		5.5	V
Under-Voltage Lockout Threshold	(turn-on)	2.45	2.55	2.65	V
UVLO Hysteresis			100		mV
Quiescent Current, PWM mode	$V_{FB} = 0.9 * V_{NOM}$ (not switching)		710	900	μA
Quiescent Current, LDO mode	$V_{LOWQ} = 0V; I_{OUT} = 0mA$		20	29	μA
Shutdown Current	$V_{EN} = 0V$		0.01	5	μA
[Adjustable] Feedback Voltage	$\pm 2\%$ (over temperature)	0.98	1	1.02	V
FB pin input current			1		nA
Current Limit in PWM Mode	$V_{FB} = 0.9 * V_{NOM}$	0.675	1	1.85	A
Output Voltage Line Regulation	$V_{OUT} > 2V; V_{IN} = V_{OUT} + 300mV$ to 5.5V; $I_{LOAD} = 100mA$ $V_{OUT} < 2V; V_{IN} = 2.7V$ to 5.5V; $I_{LOAD} = 100mA$		0.13		%
Output Voltage Load Regulation, PWM Mode	$20mA < I_{LOAD} < 300mA$		0.2	0.8	%
Output Voltage Load Regulation, LDO Mode	$100\mu A < I_{LOAD} < 50mA$ $V_{LOWQ} = 0V$		0.5	1	%
Maximum Duty Cycle	$V_{FB} \leq 0.4V$	100			%
PWM Switch ON-Resistance	$I_{SW} = 50mA$ $V_{FB} = 0.7V_{FB_NOM}$ (High Side Switch) $I_{SW} = -50mA$ $V_{FB} = 1.1V_{FB_NOM}$ (Low Side Switch)		0.4 0.4		Ω
Oscillator Frequency		3.6	4	4.4	MHz
\overline{LOWQ} threshold voltage		0.5	0.85	1.3	V
\overline{LOWQ} Input Current			0.1	2	μA
Enable Threshold		0.5	0.85	1.3	V
Enable Input Current			0.1	2	μA
LDO Dropout Voltage	$I_{OUT} = 50mA$ Note 5		110		mV

Parameter	Condition	Min	Typ	Max	Units
Output Voltage Noise	$\overline{\text{LOWQ}} = 0\text{V}$; $C_{\text{OUT}} = 4.7\mu\text{F}$, 10Hz to 100kHz		75		μVrms
LDO Current Limit	$\overline{\text{LOWQ}} = 0\text{V}$; $V_{\text{OUT}} = 0\text{V}$ (LDO Mode)	60	120		mA
Over-Temperature Shutdown			160		$^{\circ}\text{C}$
Over-Temperature Hysteresis			20		$^{\circ}\text{C}$

Notes

1. Exceeding the absolute maximum rating may damage the device.
2. The device is not guaranteed to function outside its operating rating.
3. Devices are ESD sensitive. Handling precautions recommended. Human body model: 1.5k Ω in series with 100pF.
4. Specification for packaged product only.
5. Dropout voltage is defined as the input-to-output differential at which the output voltage drops 2% below its nominal value that is initially measured at a 1V differential. For outputs below 2.7V, the dropout voltage is the input-to-output voltage differential with a minimum input voltage of 2.7V.

Typical Characteristics – PWM Mode

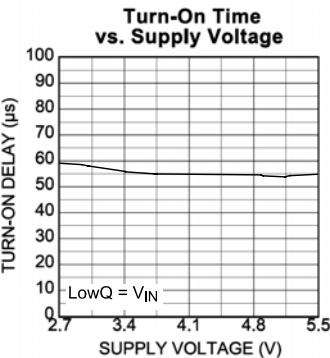
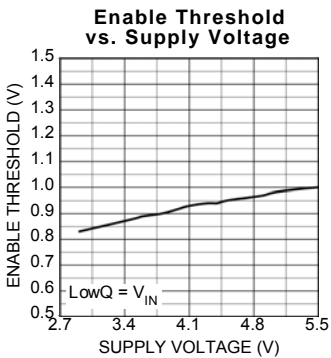
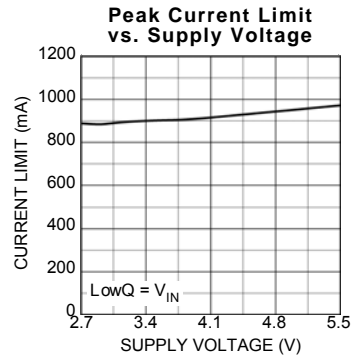
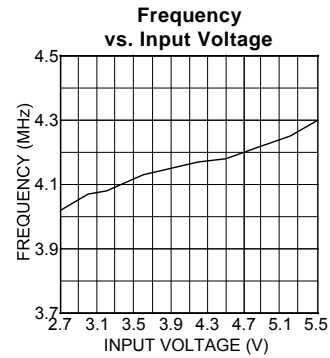
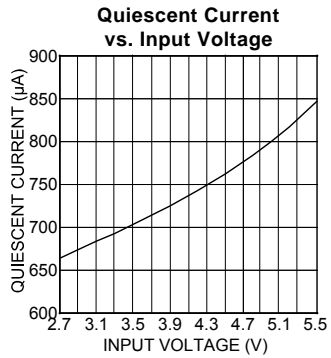
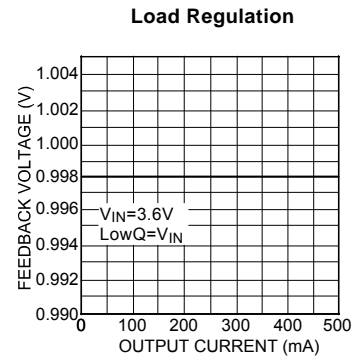
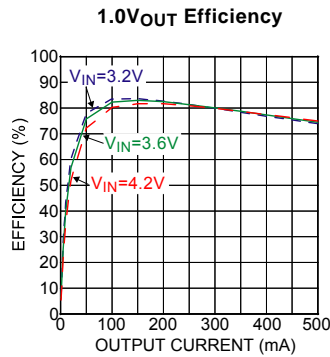
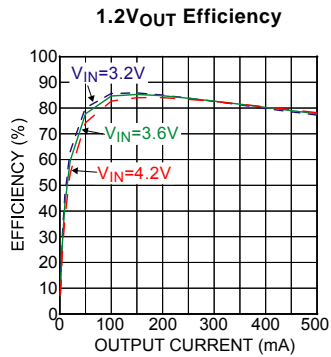
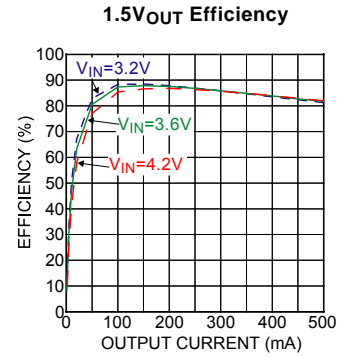
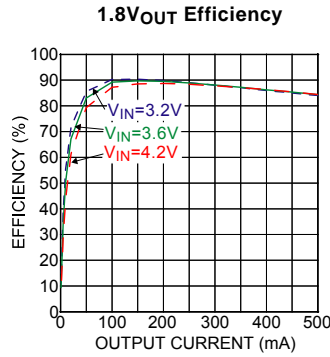
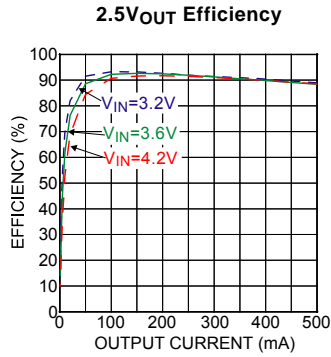

Typical Characteristics - LDO Mode

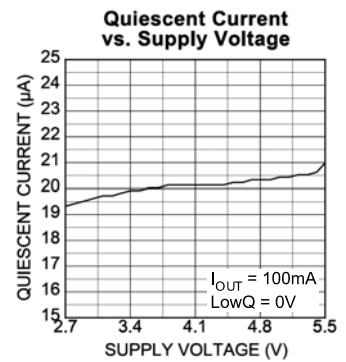
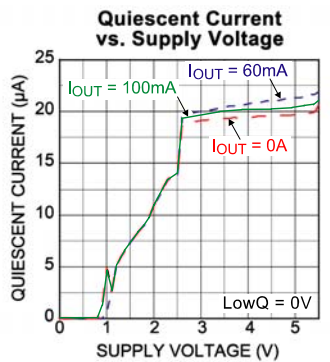
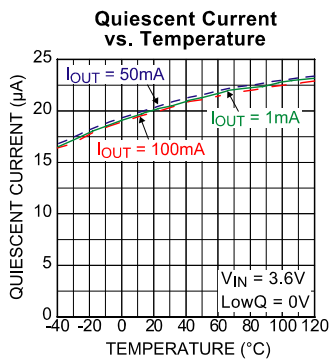
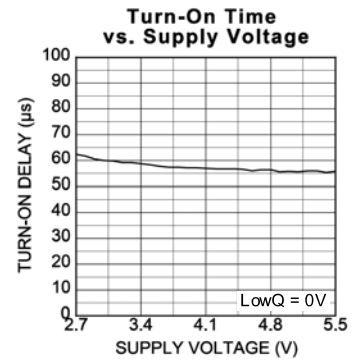
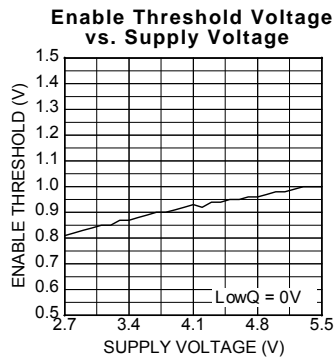
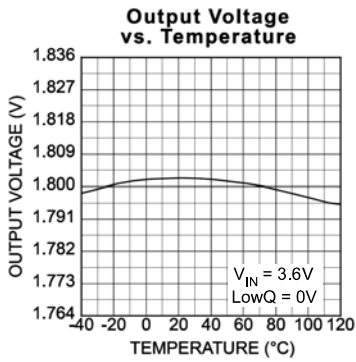
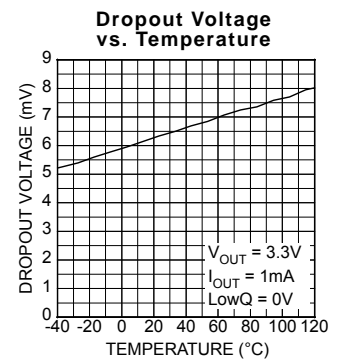
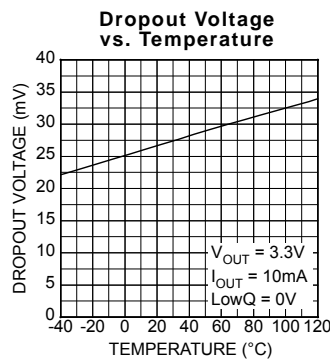
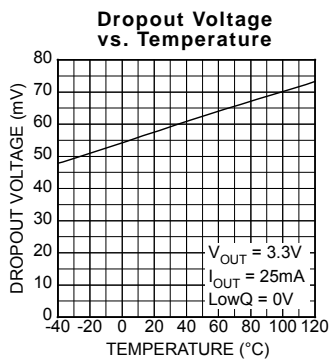
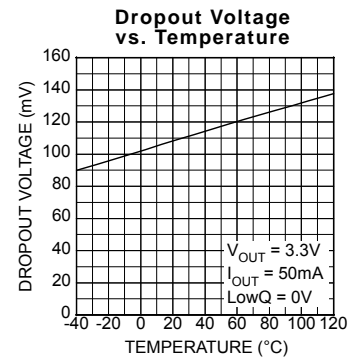
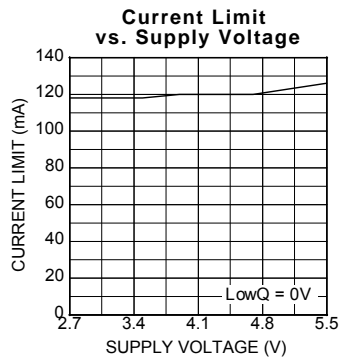
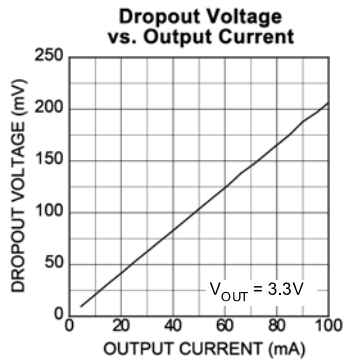

Typical Characteristics – LDO Mode (cont.)

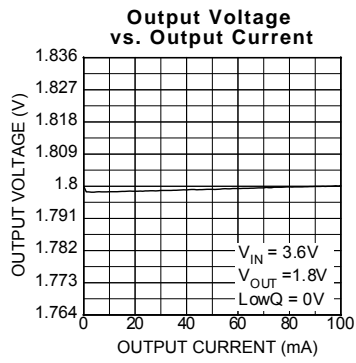
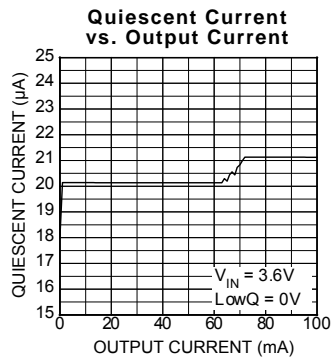

Functional Diagram

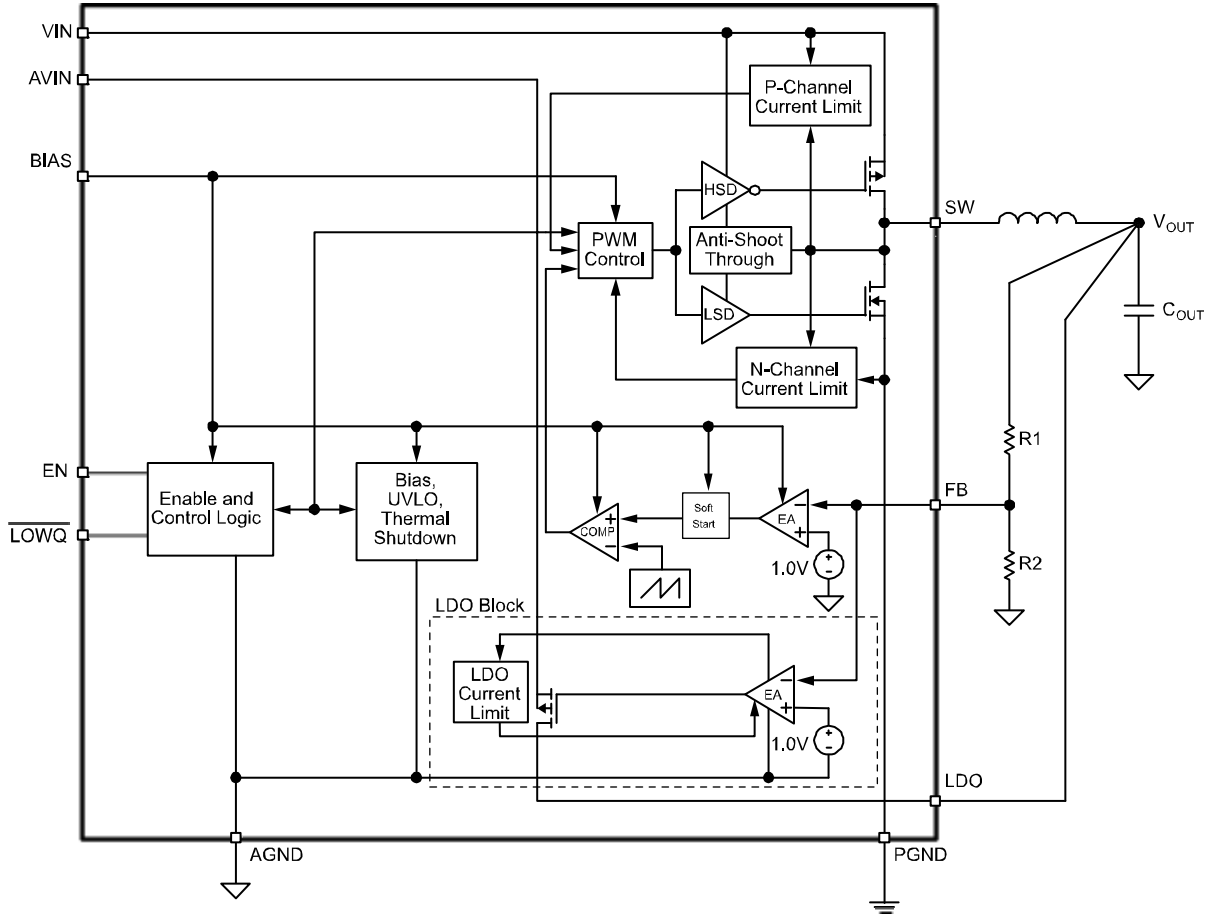

MIC2245 Block Diagram

Functional Characteristics

Load Transient PWM Mode

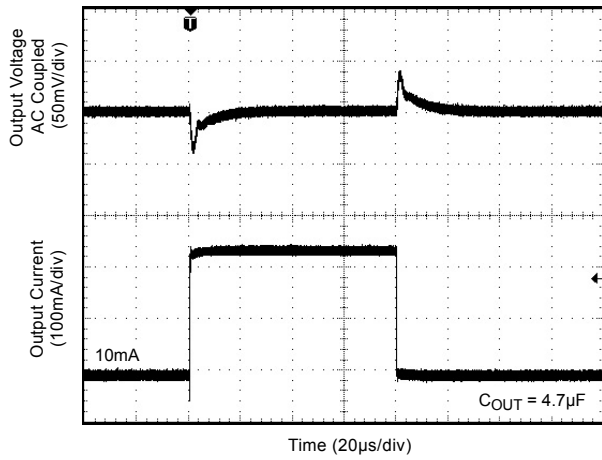

Load Transient LDO Mode

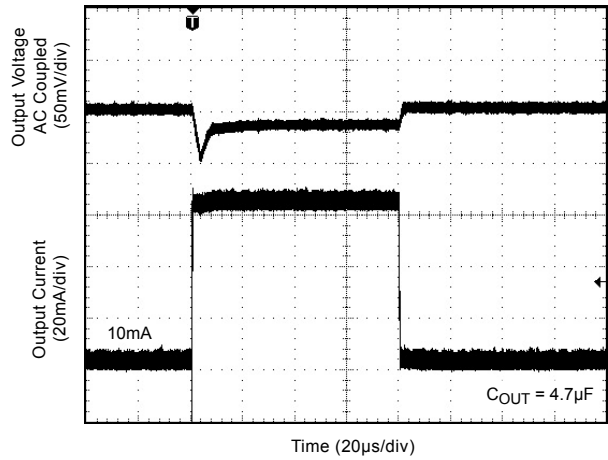

Enable Transient PWM Mode

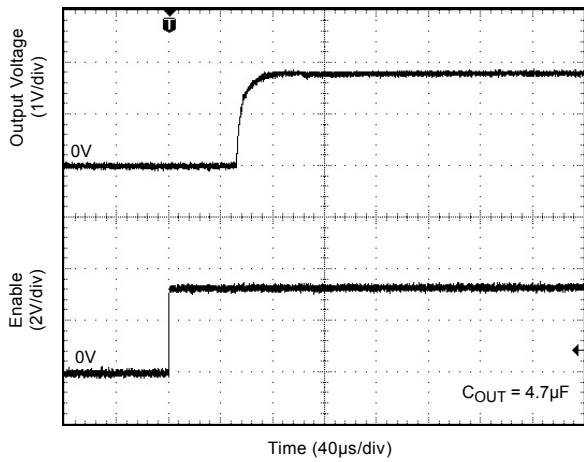

Enable Transient LDO Mode

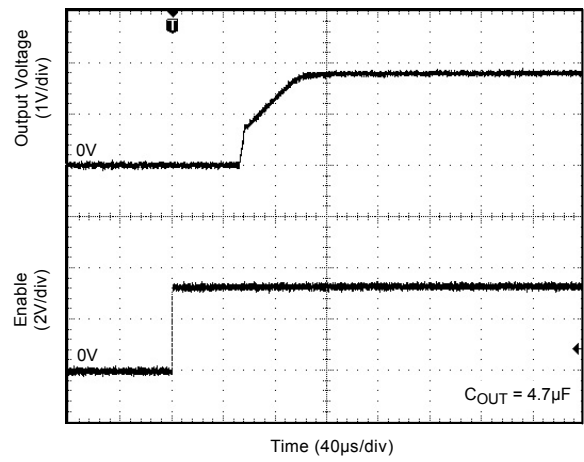

Functional Description

VIN

VIN provides power to the MOSFETs for the switch mode regulator section, along with the current limiting sensing. Due to the high switching speeds, a 1µF capacitor is recommended close to VIN and the power ground (PGND) pin for bypassing. Please refer to layout recommendations.

AVIN

Analog V_{IN} (AVIN) provides power to the LDO section. AVIN and VIN must be tied together. Careful layout should be considered to ensure high frequency switching noise caused by VIN is reduced before reaching AVIN.

LDO

The LDO pin is the output of the linear regulator and should be connected to the output. In LOWQ mode (LOWQ<1.5V), the LDO provides the output voltage. In PWM mode (LOWQ>1.5V), the LDO pin is high impedance.

EN

The enable pin provides a logic level control of the output. In the off state, supply current of the device is greatly reduced (typically <1µA). Also, in the off state, the output drive is placed in a "tri-stated" condition, where both the high side P-channel Mosfet and the low-side N-channel are in an "off" or non-conducting state. Do not drive the enable pin above the supply voltage.

LOWQ

The LOWQ pin provides a logic level control between the internal PWM mode and the low noise linear regulator mode. With LOWQ pulled low (<0.5V), quiescent current of the device is greatly reduced by switching to a low noise linear regulator mode that has a typical I_Q of 20µA. In linear (LDO) mode, the output can deliver 60mA of current to the output. By placing LOWQ high (>1.5V), this transitions the device into a constant frequency PWM buck regulator mode. This allows the device the ability to efficiently deliver up to 500mA of output current at the same output voltage.

BIAS

The BIAS pin supplies the power to the internal power to the control and reference circuitry. The bias is powered from the input voltage through an RC lowpass filter. The RC lowpass filter frequency

must be $\geq \frac{1}{2\pi(20.5\Omega)(100\text{nF})}$.

FB

The feedback pin (FB) provides the control path to control the output. For adjustable versions, a resistor divider connecting the feedback to the output is used to adjust the desired output voltage. The output voltage is calculated as follows:

$$V_{\text{OUT}} = V_{\text{REF}} \times \left(\frac{R1}{R2} + 1 \right)$$

where V_{REF} is equal to 1.0V.

A feedforward capacitor is recommended for most designs using the adjustable output voltage option. To reduce battery current draw, a 100K feedback resistor is recommended from the output to the FB pin (R1). Also, a feedforward capacitor should be connected between the output and feedback (across R1). The large resistor value and the parasitic capacitance of the FB pin can cause a high frequency pole that can reduce the overall system phase margin. By placing a feedforward capacitor, these effects can be significantly reduced. Typically an 82pF small ceramic capacitor is recommended.

SW

The switch (SW) pin connects directly to the inductor and provides the switching current necessary to operate in PWM mode. Due to the high speed switching on this pin, the switch node should be routed away from sensitive nodes.

PGND

Power ground (PGND) is the ground path for the high current PWM mode. The current loop for the power ground should be as small as possible and separate from the Analog ground (AGND) loop. Refer to the layout considerations for more details.

AGND

Signal ground (AGND) is the ground path for the biasing and control circuitry. The current loop for the signal ground should be separate from the Power ground (PGND) loop. Refer to the layout considerations for more details.

Applications Information

The MIC2245 is a 500mA PWM power supply that utilizes a LOWQ™ light load mode to maximize battery efficiency in light load conditions. This is achieved with a LOWQ control pin that when pulled low, shuts down all the biasing and drive current for the PWM regulator, drawing only 20µA of operating current. This allows the output to be regulated through the LDO output, capable of providing 60mA of output current. This method has the advantage of producing a clean, low current, ultra-low noise output in LOWQ™ mode. During LOWQ™ mode, the SW node becomes high impedance, blocking current flow. Other methods of reducing quiescent current, such as pulse frequency modulation (PFM), or bursting techniques, create large amplitude, low frequency ripple voltages that can be detrimental to system operation.

When more than 60mA is required, the $\overline{\text{LOWQ}}$ pin can be forced high, causing the MIC2245 to enter PWM mode. In this case, the LDO output makes a "hand-off" to the PWM regulator with virtually no variation in output voltage. The LDO output then turns off allowing up to 500mA of current to be efficiently supplied through the PWM output to the load.

Input Capacitor

A minimum 1µF ceramic is recommended on the VIN pin for bypassing. X5R or X7R dielectrics are recommended for the input capacitor. Y5V dielectrics lose most of their capacitance over temperature and are therefore, not recommended.

A minimum 1µF is recommended close to the VIN and PGND pins for high frequency filtering. Smaller case size capacitors are recommended due to their lower ESR and ESL. Please refer to layout recommendation section of data sheet for proper layout of the input capacitor.

Output Capacitor

The MIC2245 is optimized for a 4.7µF output capacitor. The MIC2245 utilizes type III internal compensation and utilizes an internal high frequency zero to compensate for the double pole roll off of the LC filter. For this reason, larger output capacitors can create instabilities. X5R or X7R dielectrics are recommended for the output capacitor. Y5V dielectrics lose most of their capacitance over temperature and are therefore, not recommended.

In addition to a 4.7µF, a small 10nF is recommended close to the load for high frequency filtering. Smaller case size capacitors are recommended due to their lower ESR and ESL.

Inductor Selection

The MIC2245 is designed for use with a 1.0µH inductor. Proper selection should ensure the inductor can handle the maximum average and peak currents required by the load. Maximum current ratings of the inductor are generally given in two methods; permissible DC current and saturation current. Permissible DC current can be rated either for a 40°C temperature rise or a 10% to 20% loss in inductance. Ensure that the inductor selected can handle the maximum operating current. When saturation current is specified, make sure that there is enough margin that the peak current will not saturate the inductor. Peak inductor current can be calculated as follows:

$$I_{PK} = I_{OUT} + \frac{V_{OUT} \left(1 - \frac{V_{OUT}}{V_{IN}} \right)}{2 \times f \times L}$$

Layout Recommendation

Component Placement

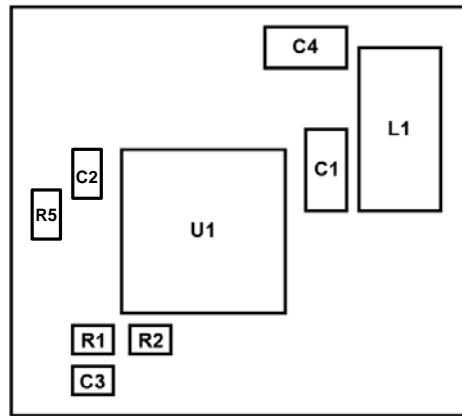

Evaluation Board Layout

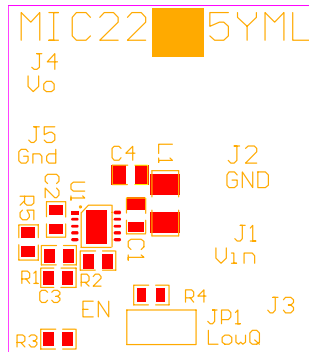
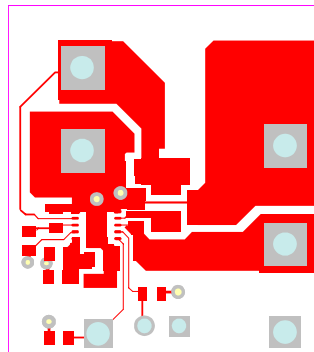

TOP

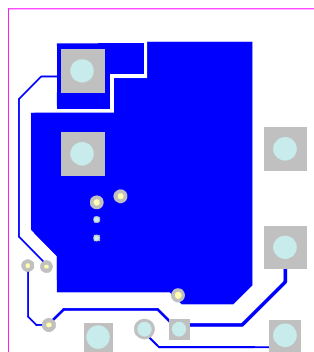

BOTTOM

Typical Application Circuit with Bill of Materials (BOM)

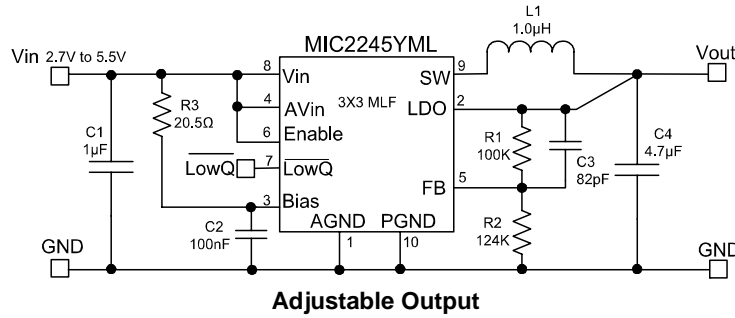

Item	Part Number	Description	Manufacturer	Qty
C1	0603D105MAT2A	1µF 6.3V X5R 0402 Ceramic Capacitor	AVX	1
	GRM185R60J105KE21D		Murata	
	C1608X5R1A105K		TDK	
C4	C1608X5R0J475M	4.7µF 6.3V X5R 0603 Ceramic Capacitor	TDK	1
	GRM188R60J475KE19D		Murata	
	VJ0603Y475KXQCW1BC		Vishay	
	06036D475MAT2A		AVX	
C2	C1005X5R0J104M	0.1µF 6.3V X5R 0402 Ceramic Capacitor	Murata	1
	04026D104MAT2A		AVX	
	GRM155R60J104K		TDK	
C3	VJ0402A820KXQCW1BC	82pF X7R 0402 Ceramic Capacitor	Vishay	1
	C1005COG1H820J	82pF COG 0402 Ceramic Capacitor	TDK	
L1	DO2010-102ML	1µH Inductor	Colicraft	1
	GLF2518T1R0M	1µH Inductor	TDK	
R1 ⁽⁷⁾	CRCW04021003F	100kΩ 1% 0402 Resistor	Vishay	1
R2 ⁽⁷⁾	CRCW04026652F	66.5kΩ 1% 0402 Resistor for 2.5V _{OUT}	Vishay	1
	CRCW04021243F	124kΩ 1% 0402 Resistor for 1.8V _{OUT}	Vishay	
	CRCW04022003F	200kΩ 1% 0402 Resistor for 1.5V _{OUT}	Vishay	
	CRCW04024993F	499kΩ 1% 0402 Resistor for 1.2V _{OUT}	Vishay	
		Open	for 1.0V _{OUT}	
R3	CRCW040220R5F	20.5Ω 1% 0402 Resistor	Vishay	1
U1	MIC2245YML	4MHz PWM Step-Down Converter/LDO	Micrel	1

Notes:

1. AVX: www.avxcorp.com
2. Murata: www.murata.com
3. TDK: www.tdk.com
4. Vishay: www.vishay.com
5. Coilcraft: www.coilcraft.com
6. Micrel, Inc.: www.micrel.com
7. For Adjustable Version Only

Package Information

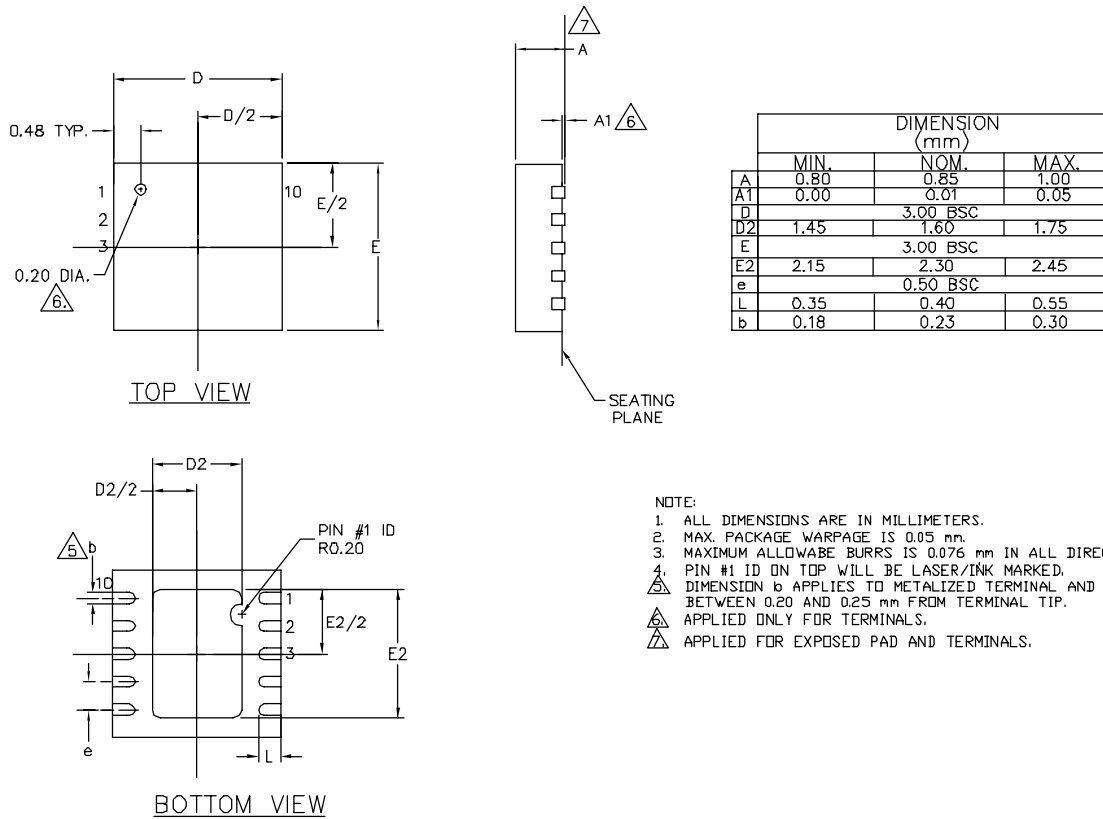

10-Pin 3mm x 3mm MLF™ (ML)

MICREL, INC. 2180 FORTUNE DRIVE SAN JOSE, CA 95131 USA
 TEL +1 (408) 944-0800 FAX +1 (408) 474-1000 WEB <http://www.micrel.com>

The information furnished by Micrel in this data sheet is believed to be accurate and reliable. However, no responsibility is assumed by Micrel for its use. Micrel reserves the right to change circuitry and specifications at any time without notification to the customer.

Micrel Products are not designed or authorized for use as components in life support appliances, devices or systems where malfunction of a product can reasonably be expected to result in personal injury. Life support devices or systems are devices or systems that (a) are intended for surgical implant into the body or (b) support or sustain life, and whose failure to perform can be reasonably expected to result in a significant injury to the user. A Purchaser's use or sale of Micrel Products for use in life support appliances, devices or systems is a Purchaser's own risk and Purchaser agrees to fully indemnify Micrel for any damages resulting from such use or sale.

© 2006 Micrel, Incorporated.