

# TOSHIBA

## INTEGRATED GTR MODULE

MIG20J901H

Unit in mm

### High Power Switching Applications

#### Motor Control Applications

- Integrates Inverter, Converter and Brake Power Circuits in One Package.
- Output (Inverter Stage)
  - : 3 $\phi$ 20A/600V High Speed Type IGBT
  - $V_{CE(sat)}$  = 4.00V (Max.)
  - $t_f$  = 0.30 $\mu$ s (Max.)
  - $t_{rr}$  = 0.15 $\mu$ s (Max.)
- Input (Converter Stage)
  - : 3 $\phi$ 20A/800V Silicon Rectifier
  - $V_F$  = 1.20V (Max.)
- Brake Stage
  - : 15A/600V IGBT & 15A/600V FRD
- The Electrodes are Isolated from Case.

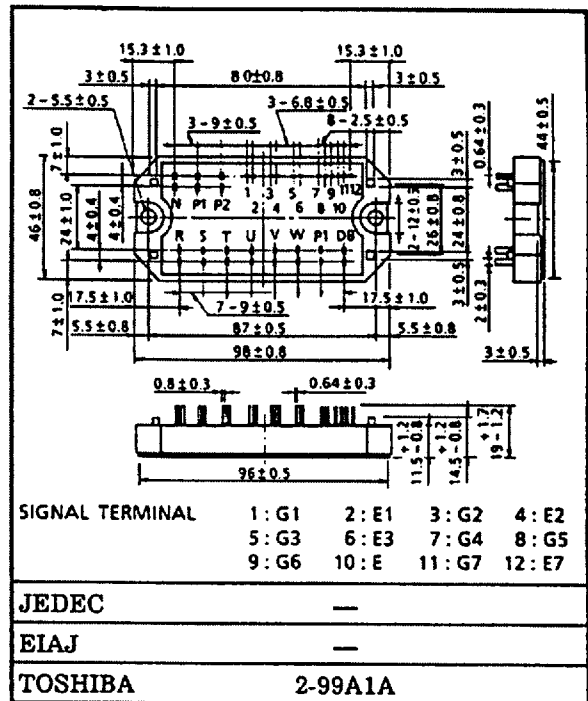

Weight : 175g

### Equivalent Circuit

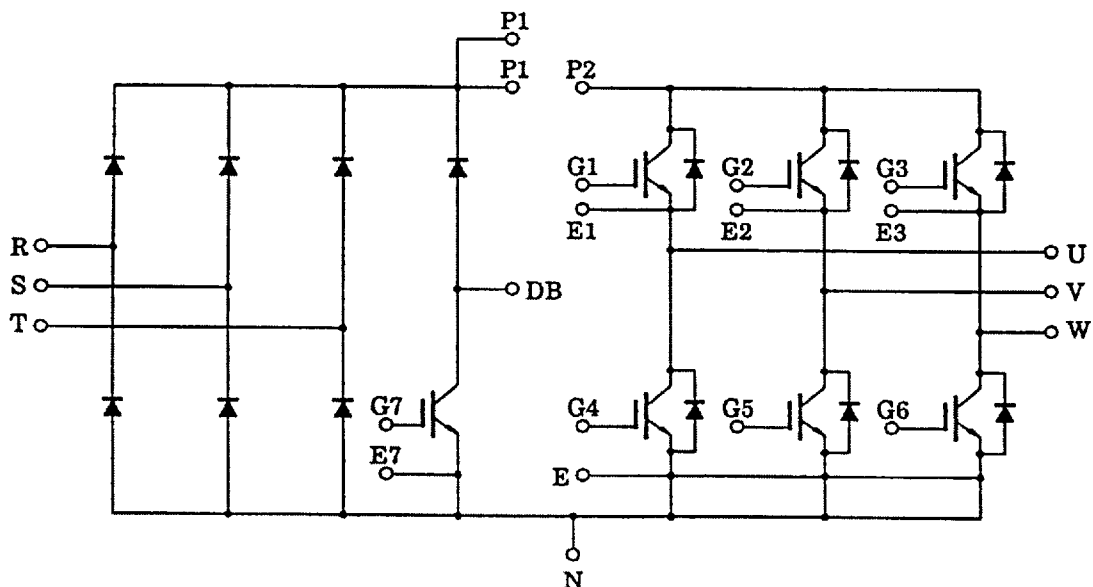

The information contained here is subject to change without notice.  
 The information contained herein is presented only as guide for the applications of our products. No responsibility is assumed by TOSHIBA for any infringements of patents or other rights of the third parties which may result from its use. No license is granted by implication or otherwise under any patent or patent rights of TOSHIBA or others. These TOSHIBA products are intended for usage in general electronic equipments (office equipment, communication equipment, measuring equipment, domestic electrification, etc.) Please make sure that you consult with us before you use these TOSHIBA products in equipments which require high quality and/or reliability, and in equipments which could have major impact to the welfare of human life (atomic energy control, spaceship, traffic signal, combustion control, all types of safety devices, etc.)

# MIG20J901H

## Maximum Ratings (Ta = 25°C)

STAGE		CHARACTERISTIC		SYMBOL	RATINGS	UNIT		
Inverter		Collector-Emitter Voltage		$V_{CES}$	600	V		
		Gate-Emitter Voltage		$V_{GES}$	±20	V		
		Collector Current		DC	$I_C$	20	A	
				1ms	$I_{CP}$	40		
		Forward Current		DC	$I_F$	20	A	
				1ms	$I_{FM}$	40		
		Collector Power Dissipation (Tc = 25°C)		$P_C$	80	W		
Converter		Repetitive Peak Reverse Voltage		$V_{RRM}$	800	V		
		Average Output Rectified Current		$I_O$	20	A		
		Peak One Cycle Surge Forward Current (50Hz, Non-Repetitive)		$I_{FSM}$	250	A		
Brake		IGBT		Collector-Emitter Voltage		$V_{CES}$	600	V
				Gate-Emitter Voltage		$V_{GES}$	±20	V
				DC	$I_C$	15	A	
				1ms	$I_{CP}$	30		
				Collector Power Dissipation (Tc = 25°C)		$P_C$	65	W
		FRD		Repetitive Peak Reverse Voltage		$V_{RRM}$	600	V
				Forward Current		DC	$I_F$	15
1ms	$I_{FM}$					30		
Module		Junction Temperature		$T_j$	150	°C		
		Storage Temperature Range		$T_{stg}$	-40 ~ 125	°C		
		Isolation Voltage		$V_{isol}$	2500 (AC 1 minute)	V		
		Screw Torque		—	3	N•m		

## Electrical Characteristics (Ta = 25°C)

## a. Inverter Stage

CHARACTERISTIC		SYMBOL	TEST CONDITION	MIN.	TYP.	MX.	UNIT
Gate Leakage Current		$I_{GES}$	$V_{GE} = \pm 20V, V_{CE} = 0$	-	-	$\pm 20$	$\mu A$
Collector Cut-off Current		$I_{CES}$	$V_{CE} = 600V, V_{GE} = 0$	-	-	1.0	mA
Gate-Emitter Cut-off Voltage		$V_{GE (off)}$	$V_{CE} = 5V, I_C = 20mA$	3.0	-	6.0	V
Collector-Emitter Saturation Voltage		$V_{CE (sat)}$	$I_C = 20A, V_{GE} = 15V$	-	3.0	4.0	V
Input Capacitance		$C_{ies}$	$V_{CE} = 10V, V_{GE} = 0$ $f = 1MHz$	-	1300	-	pF
Switching Time	Turn-on Delay Time	$t_{d(on)}$	Inductive Load $V_{CC} = 300V$ $I_C = 20A$ $V_{GE} = \pm 15V$ $R_G = 120\Omega$ (Note 1)	-	0.08	0.16	$\mu s$
	Rise Time	$t_r$		-	0.12	0.24	
	Turn-on Time	$t_{on}$		-	0.40	0.80	
	Turn-off Delay Time	$t_{d(off)}$		-	0.30	0.60	
	Fall Time	$t_f$		-	0.15	0.30	
	Turn-off Time	$t_{off}$		-	0.60	1.00	
Forward Voltage		$V_F$	$I_F = 20A, V_{GE} = 0$	-	1.7	2.5	V
Reverse Recovery Time		$t_{rr}$	$I_F = 20A, V_{GE} = -10V$ $di/dt = 50A/\mu s$	-	0.08	0.15	$\mu s$
Thermal Resistance		$R_{th(j-c)}$	Transistor	-	-	1.56	$^{\circ}C/W$
			Diode	-	-	2.80	

## b. Converter Stage

CHARACTERISTIC	SYMBOL	TEST CONDITION	MIN.	TYP.	MX.	UNIT
Repetitive Peak Reverse Current	$I_{RRM}$	$V_{RRM} = 800V$	-	-	50	$\mu A$
Peak Forward Voltage	$V_{FM}$	$I_{FM} = 20A$	-	1.05	1.20	V
Peak One Cycle Surge Forward Current	$I_{FSM}$	50Hz Sine-half-wave	250	-	-	A
Thermal Resistance	$R_{th(j-c)}$	-	-	-	2.50	$^{\circ}C/W$

# MIG20J901H

## c. Brake Stage

CHARACTERISTIC		SYMBOL	TEST CONDITION	MIN.	TYP.	MX.	UNIT
Gate Leakage Current		$I_{GES}$	$V_{GE} = \pm 20V, V_{CE} = 0$	-	-	$\pm 20$	$\mu A$
Collector Cut-off Current		$I_{CES}$	$V_{CE} = 600V, V_{GE} = 0$	-	-	1.0	mA
Repetitive Peak Reverse Current		$I_{RRM}$	$V_{RRM} = 600V$	-	-	1.0	mA
Gate-Emitter Cut-off Voltage		$V_{GE(off)}$	$V_{CE} = 5V, I_C = 15mA$	3.0	-	6.0	V
Collector-Emitter Saturation Voltage		$V_{CE(sat)}$	$I_C = 15A, V_{GE} = 15V$	-	3.0	4.0	V
Input Capacitance		$C_{ies}$	$V_{CE} = 10V, V_{GE} = 0$ $f = 1MHz$	-	1000	-	pF
Switching Time	Turn-on Delay Time	$t_{d(on)}$	Inductive Load	-	0.08	0.16	$\mu s$
	Rise Time	$t_r$	$V_{CC} = 300V$	-	0.12	0.24	
	Turn-on Time	$t_{on}$	$I_C = 15A$	-	0.40	0.80	
	Turn-off Delay Time	$t_{d(off)}$	$V_{GE} = \pm 15V$	-	0.30	0.60	
	Fall Time	$t_f$	$R_G = 150\Omega$	-	0.30	0.55	
	Turn-off Time	$t_{off}$	(Note 1)	-	0.65	1.00	
Forward Voltage		$V_F$	$I_F = 15A, V_{GE} = 0$	-	1.7	2.5	V
Thermal Resistance		$R_{th(j-c)}$	Transistor	-	-	1.92	$^{\circ}C/W$
			Diode	-	-	2.80	

Note. 1 Switching Time Test Circuit & Timing Chart

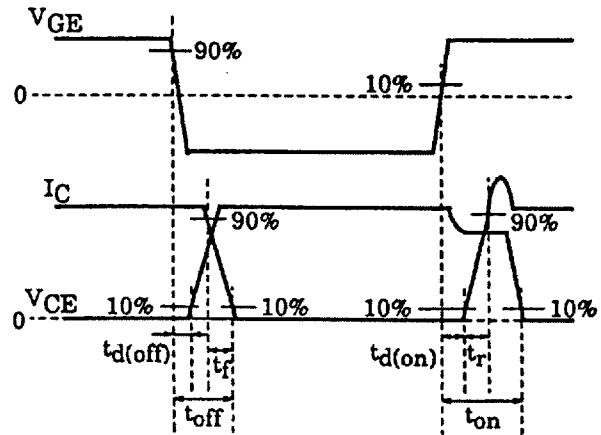
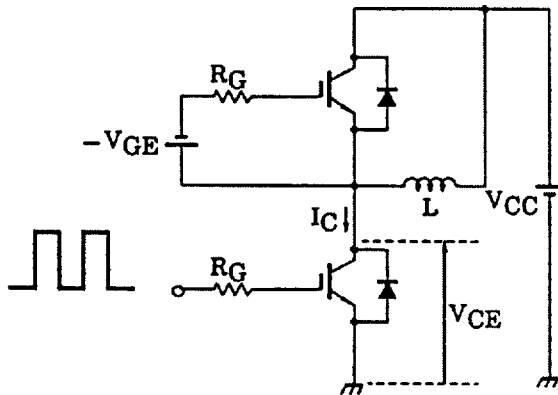

a. Inverter Stage

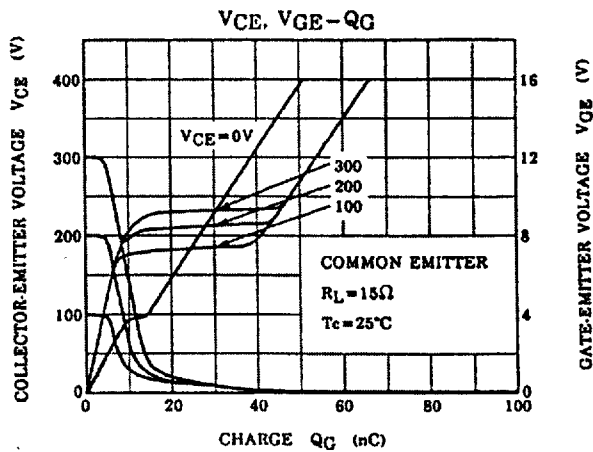
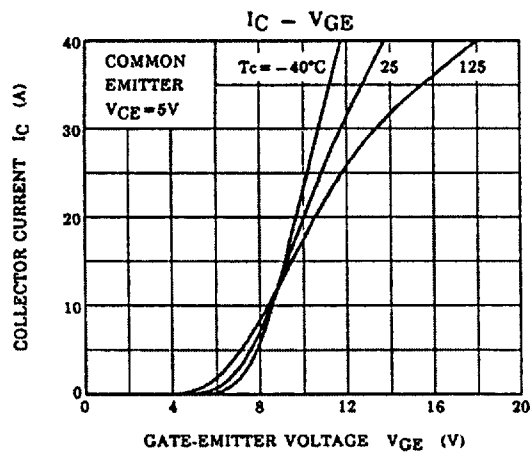
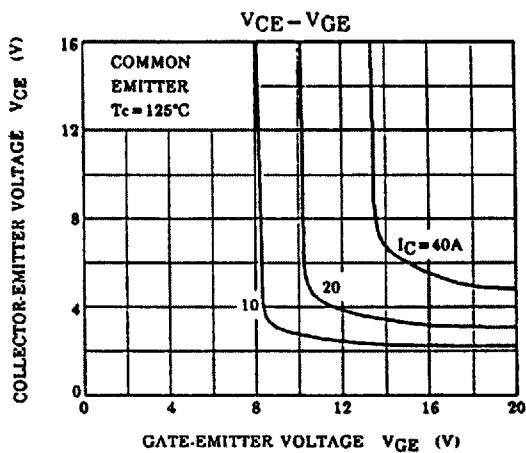
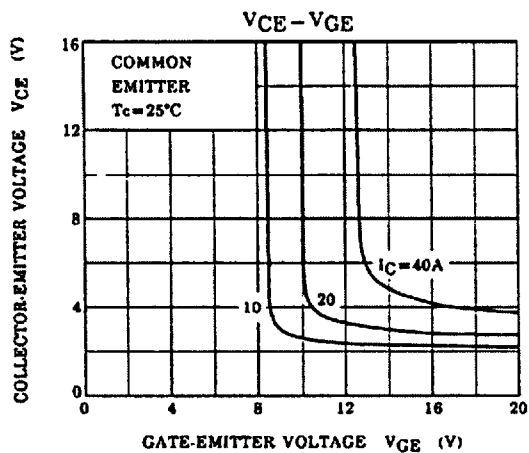
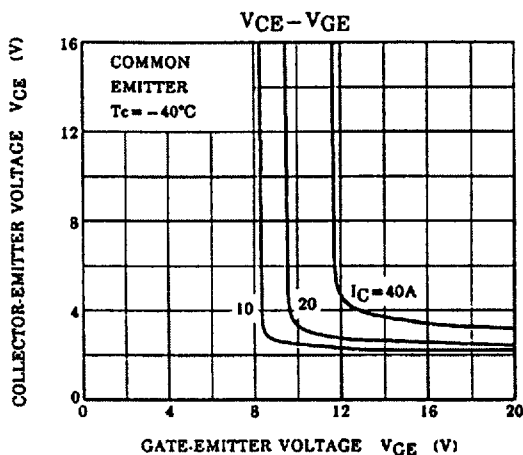
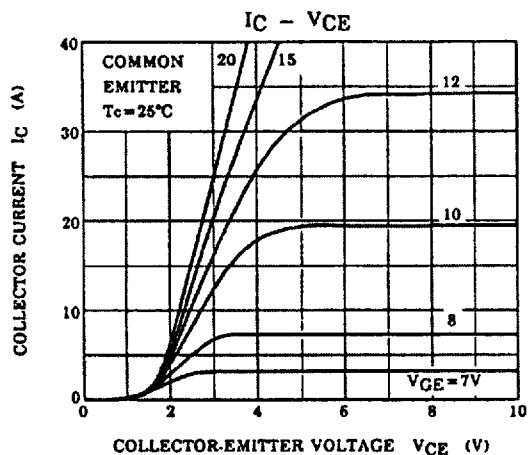

# MIG20J901H

## a. Inverter Stage

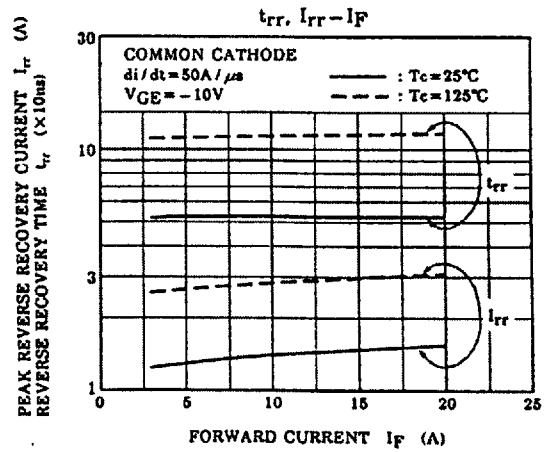
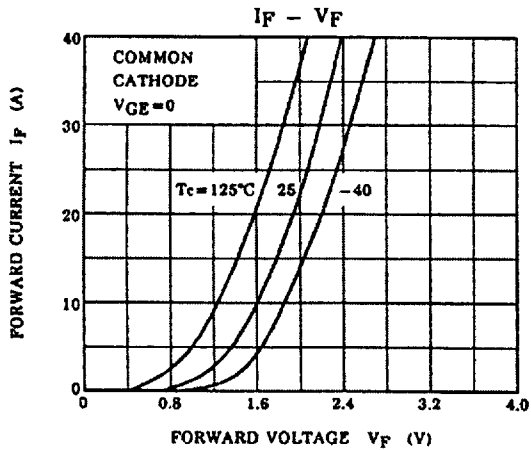
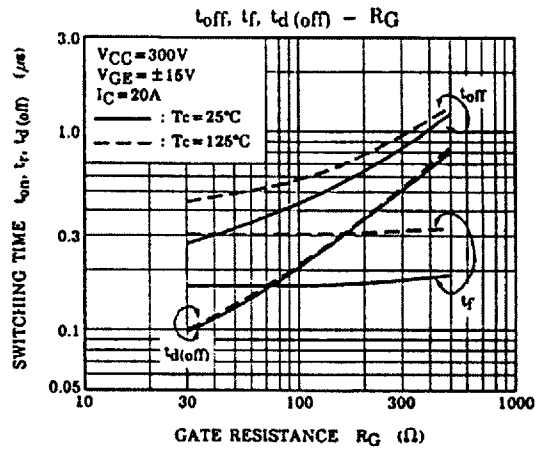
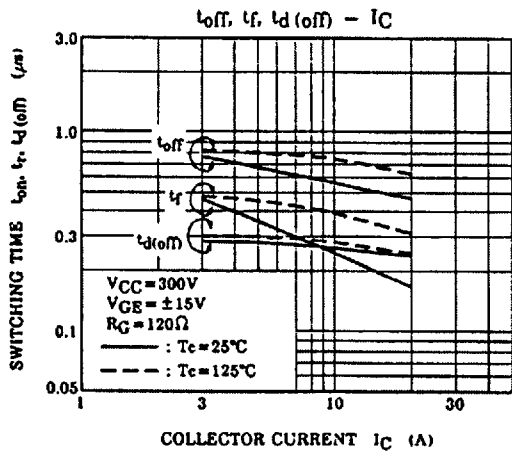
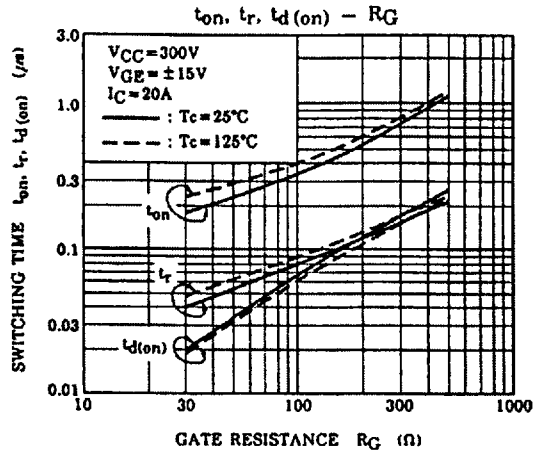
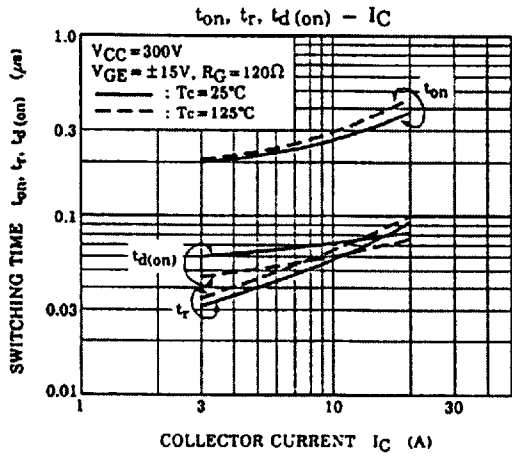

a. Inverter Stage

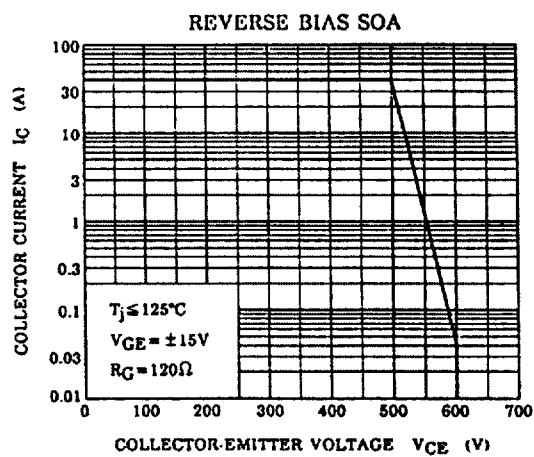
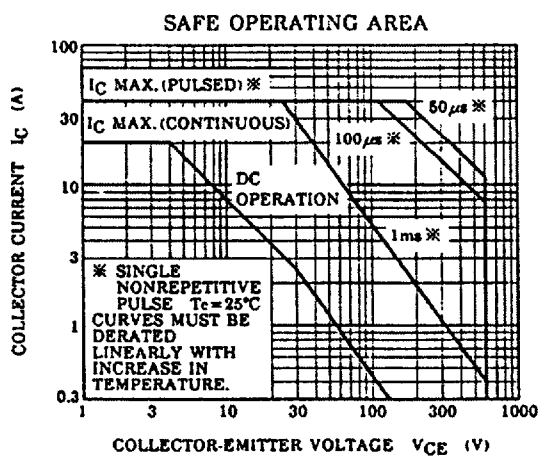
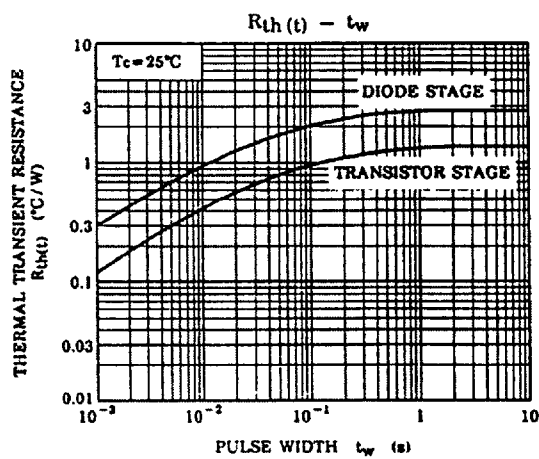
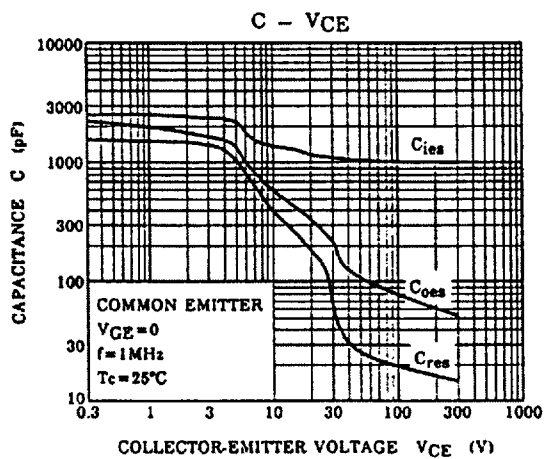

# MIG20J901H

## b. Converter Stage

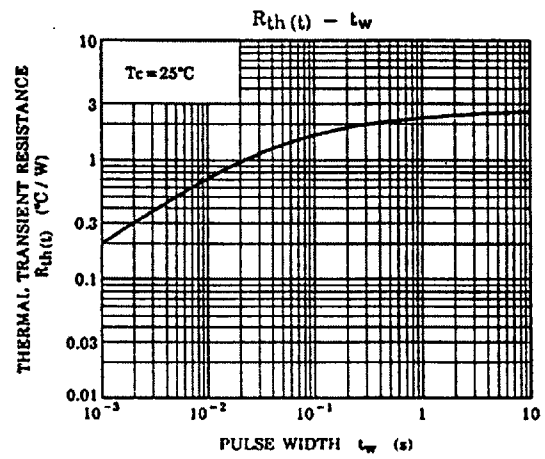
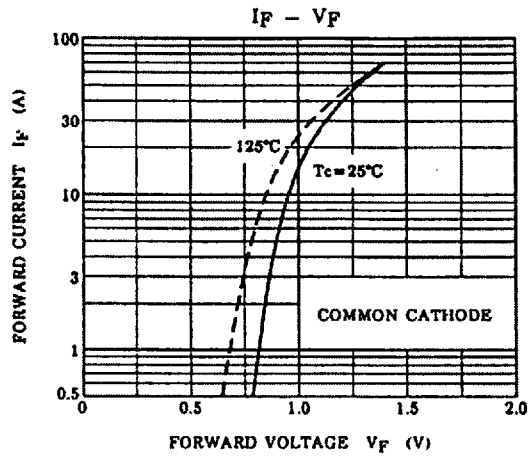



c. Brake Stage

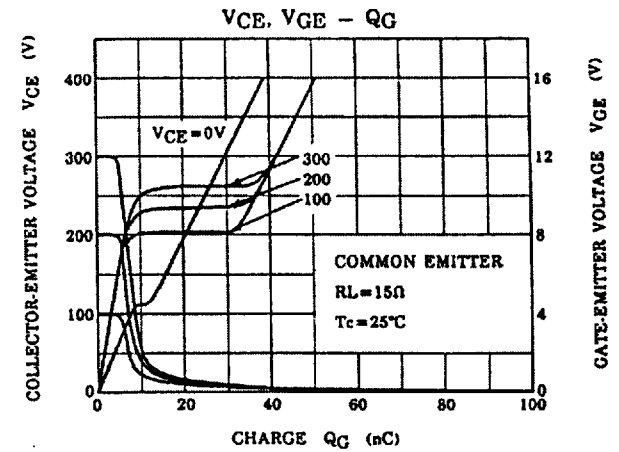
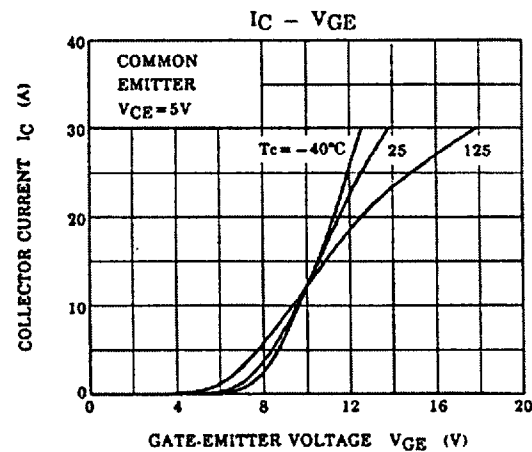
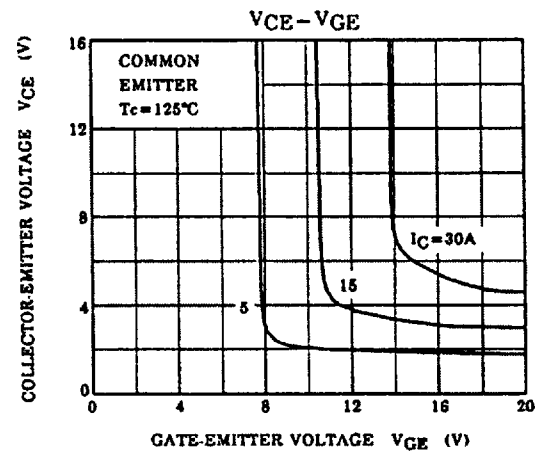
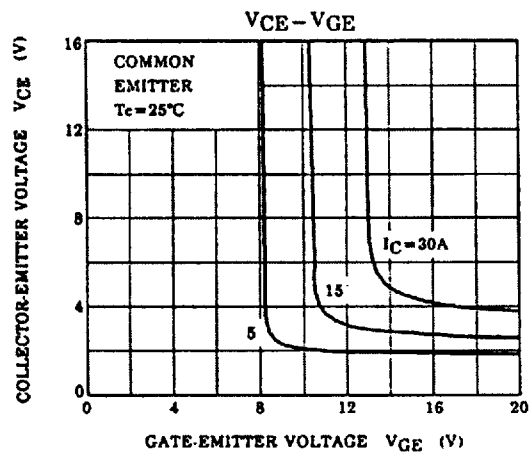
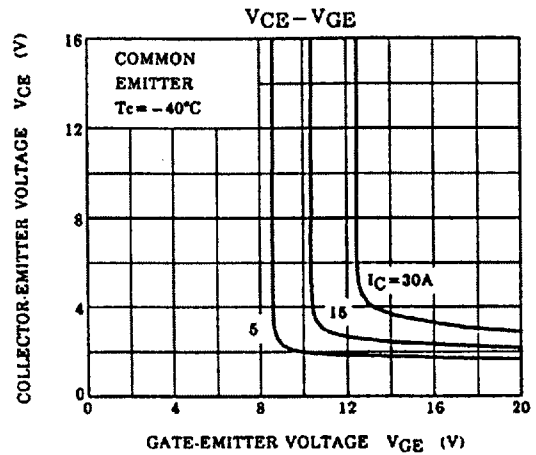
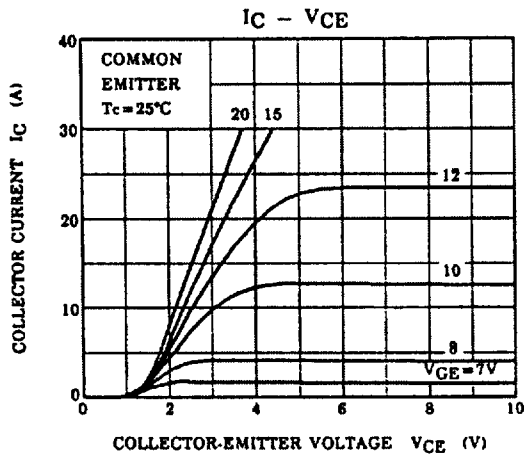

MIG20J901H

c. Brake Stage

(MIG20J901H)

c. Brake Stage

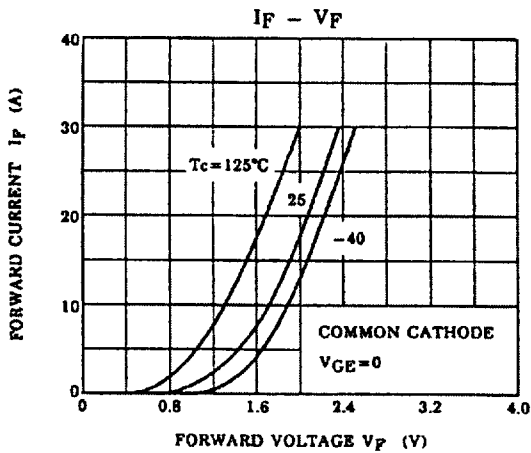
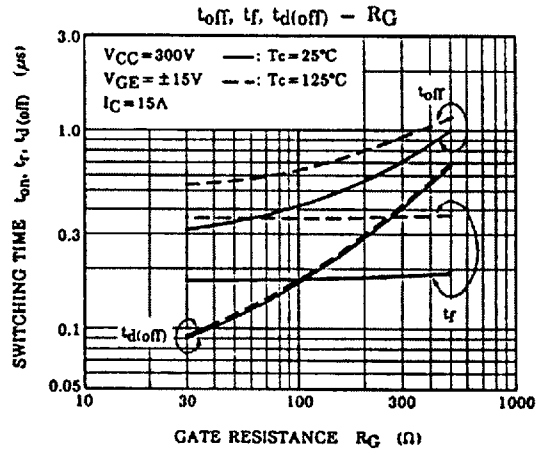
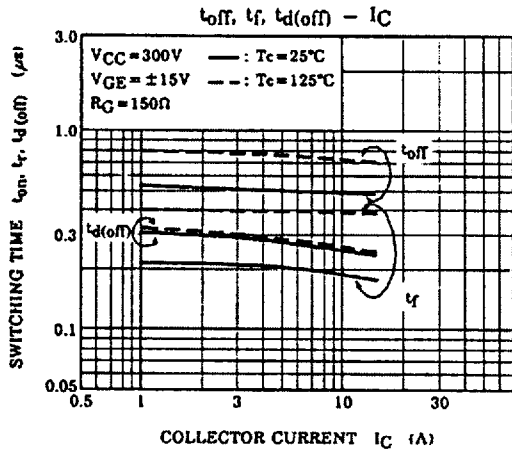
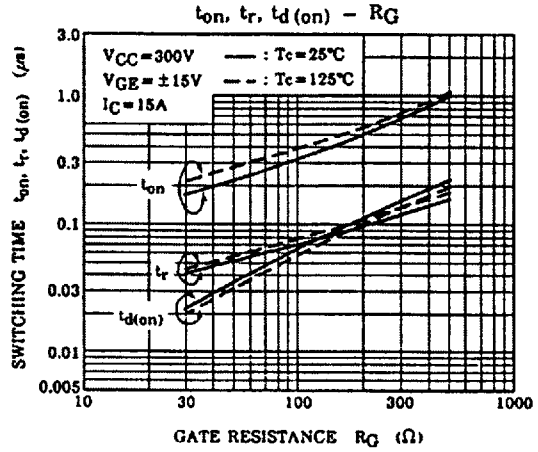
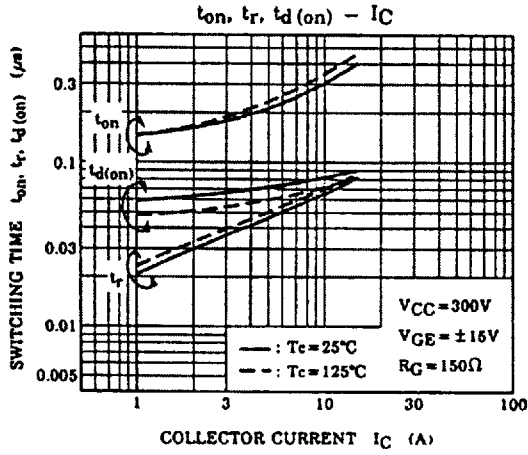

c. Brake Stage

