

MITSUBISHI LASER DIODES
ML1XX26 SERIES
 FOR OPTICAL INFORMATION SYSTEMS

**TYPE
NAME**

ML101J26

DESCRIPTION

ML1XX26 is a high-power, high-efficient AlGaInP semiconductor laser which provides a stable, single transverse mode oscillation with emission wavelength of 658nm and standard pulse light output of 300mW.

ML1XX26 has a real-index-waveguide which improves the slope efficiency (reduction of the operating current) and the astigmatic distance.

Also, ML1XX26 has a window-mirror-facet which improves the maximum output power. That leads to highly reliable and high-power operation at 75 °C.

FEATURES

- High Output Power: 300mW (Pulse)
- High Efficiency: 0.95W/A (typ.)
- Visible Light: 658nm (typ.)
- Low Aspect Ratio ($\theta_{\perp} / \theta_{//}$): 1.8 (typ.)
- Low Astigmatic Distance: 1 μ m (typ.)

APPLICATION

Portable High-Density Optical Disc Drives
 Re-Writable DVD Drives

ABSOLUTE MAXIMUM RATINGS (Note 1)

Symbol	Parameter	Conditions	Ratings	Unit
Po	Light output power	CW	100	mW
		Pulse(Note 2)	300	
VRL	Reverse voltage	-	2	V
Tc	Case temperature	-	-10 ~ +75	°C
Tstg	Storage temperature	-	-40 ~ +100	°C

Note1: The maximum rating means the limitation over which the laser should not be operated even instant time. This does not mean the guarantee of its lifetime. As for the reliability, please refer to the reliability report issued by Quality Assurance Section, HF & Optical Semiconductor Division, Mitsubishi Electric Corporation.

Note2: TARGET SPEC /Condition Duty Cycle: less than 35%, pulse width: less than 30ns

ELECTRICAL/OPTICAL CHARACTERISTICS (Tc=25° C)

Symbol	Parameter	Test conditions	Min.	Typ.	Max	Unit
I _{th}	Threshold current	CW	-	65	-	mA
I _{op}	Operating current	CW, Po=80mW	-	150	-	mA
V _{op}	Operating voltage	CW, Po=80mW	-	2.4	3.0	V
η	Slope efficiency	CW, Po=80mW	-	0.95	-	mW/mA
λ_p	Peak wavelength	CW, Po=80mW	654	658	662	nm
$\theta_{//}$	Beam divergence angle (parallel)	CW, Po=80mW	7	9.5	12	°
θ_{\perp}	Beam divergence angle (perpendicular)	CW, Po=80mW	14	17	20	°

MITSUBISHI LASER DIODES
ML1XX26 SERIES
 FOR OPTICAL INFORMATION SYSTEMS

OUTLINE DRAWINGS

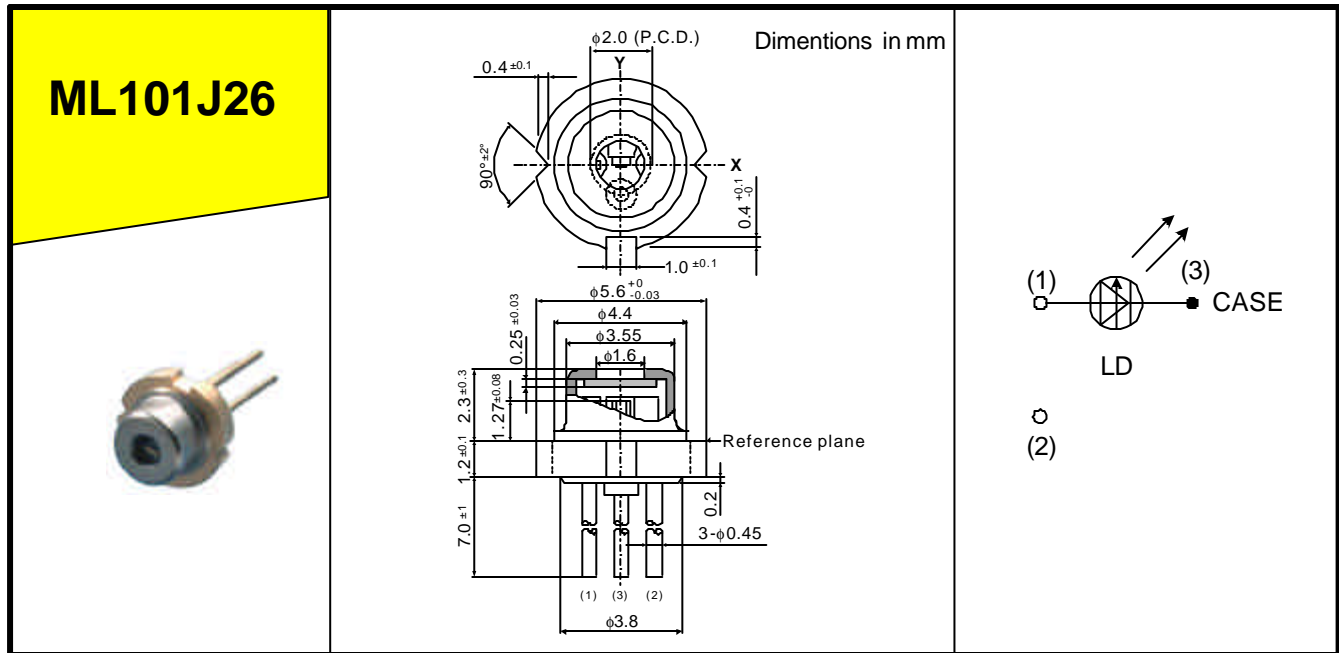

There is no model with a monitor photo diode in ML1XX26 series.

Requests Regarding Safety Designs

Mitsubishi Electric constantly strives to raise the level of its quality and reliability. Despite these concerted efforts, however, there will be occasions when our semiconductor products suffer breakdowns, malfunctions or other problems. In view of this reality, it is requested that every feasible precaution be taken in the pursuit of redundancy design, malfunction prevention design and other safety-related designs, to prevent breakdowns or malfunctions in our products from resulting in accidents involving people, fires, social losses or other problems, thereby upholding the highest levels of safety in the products when in use by customers.

Matters of Importance when Using these Materials

1. These materials are designed as reference materials to ensure that all customers purchase Mitsubishi Electric semiconductors best suited to their specific use applications. Please be aware, however, that the technical information contained in these materials does not comprise consent for the execution or use of intellectual property rights or other rights owned by Mitsubishi Electric Corporation.
2. Mitsubishi Electric does not assume responsibility for damages resulting from the use of product data, graphs, charts, programs, algorithms or other applied circuit examples described in these materials, or for the infringement of the rights of third-party owners resulting from such use.
3. The data, graphs, charts, programs, algorithms and all other information described in these materials were current at the issue of these materials, with Mitsubishi Electric reserving the right to make any necessary updates or changes in the products or specifications in these materials without prior notice. Before purchasing Mitsubishi Electric semiconductor products, therefore, please obtain the latest available information from Mitsubishi Electric directly or an authorized dealer.
4. Every possible effort has been made to ensure that the information described in these materials is fully accurate. However, Mitsubishi Electric assumes no responsibility for damages resulting from inaccuracies occurring within these materials.
5. When using the product data, technical contents indicated on the graphs, charts, programs or algorithms described in these materials, assessments should not be limited to only the technical contents, programs and algorithm units. Rather, it is requested that ample evaluations be made of each individual system as a whole, with the customer assuming full responsibility for decisions on the propriety of application. Mitsubishi Electric does not accept responsibility for the propriety of application.
6. The products described in these materials, with the exception of special mention concerning use and reliability, have been designed and manufactured with the purpose of use in general electronic machinery. Accordingly these products have not been designed and manufactured with the purpose of application in machinery or systems that will be used under conditions that can affect human life, or in machinery or systems used in social infrastructure that demand a particularly high degree of reliability. When considering the use of the products described in these materials in transportation machinery (automobiles, trains, vessels), for objectives related to medical treatment, aerospace, nuclear power control, submarine repeaters or systems or other specialized applications, please consult with Mitsubishi Electric directly or an authorized dealer.
7. When considering use of products for purposes other than the specific applications described in these materials, please inquire at Mitsubishi Electric or an authorized dealer.
8. The prior consent of Mitsubishi Electric in writing is required for any reprinting or reproduction of these materials.
9. Please direct any inquiries regarding further details of these materials, or any other comments or matters of attention, to Mitsubishi Electric or an authorized dealer.