

MITSUBISHI LASER DIODES
ML1XX18 SERIES
 FOR OPTICAL INFORMATION SYSTEMS

**TYPE
NAME**

ML101J18, ML120G18

DESCRIPTION

ML1XX18 is a high-power, high-efficient AlGaInP semiconductor laser which provides a stable, single transverse mode oscillation with emission wavelength of 658nm and standard pulse light output of 100mW.

ML1XX18 has a real-index-waveguide which improves the slope efficiency (reduction of the operating current) and the astigmatic distance.

Also, ML1XX18 has a window-mirror-facet which improves the maximum output power. That leads to highly reliable and high-power operation.

FEATURES

- High Output Power: 100mW (Pulse)
- High Efficiency: 1.0W/A (typ.)
- Visible Light: 658nm (typ.)
- Low Astigmatic Distance: 1 μ m (typ.)

APPLICATION

Portable High-Density Optical Disc Drives
 Re-Writable DVD Drives

ABSOLUTE MAXIMUM RATINGS (Note 1)

Symbol	Parameter	Conditions	Ratings	Unit
Po	Light output power	CW	60	mW
		Pulse(Note 2)	100	
VRL	Reverse voltage	-	2	V
Tc	Case temperature	-	-10 ~ +70	°C
Tstg	Storage temperature	-	-40 ~ +100	°C

Note1: The maximum rating means the limitation over which the laser should not be operated even instant time. This does not mean the guarantee of its lifetime. As for the reliability, please refer to the reliability report issued by Quality Assurance Section, HF & Optical Semiconductor Division, Mitsubishi Electric Corporation.

Note2: TARGET SPEC /Condition Duty Cycle: less than 50%, pulse width: less than 100ns

ELECTRICAL/OPTICAL CHARACTERISTICS (Tc=25°C)

Symbol	Parameter	Test conditions	Min.	Typ.	Max	Unit
Ith	Threshold current	CW	-	45	-	mA
Iop	Operating current	CW, Po=50mW	-	95	-	mA
Vop	Operating voltage	CW, Po=50mW	-	2.5	3.0	V
η	Slope efficiency	CW, Po=50mW	-	1.0	-	mW/mA
λ_p	Peak wavelength	CW, Po=50mW	654	658	662	nm
$\theta_{//}$	Beam divergence angle (parallel)	CW, Po=50mW	7	9	12	°
θ_{\perp}	Beam divergence angle (perpendicular)	CW, Po=50mW	17	19	22	°

MITSUBISHI LASER DIODES
ML1XX18 SERIES
 FOR OPTICAL INFORMATION SYSTEMS

OUTLINE DRAWINGS

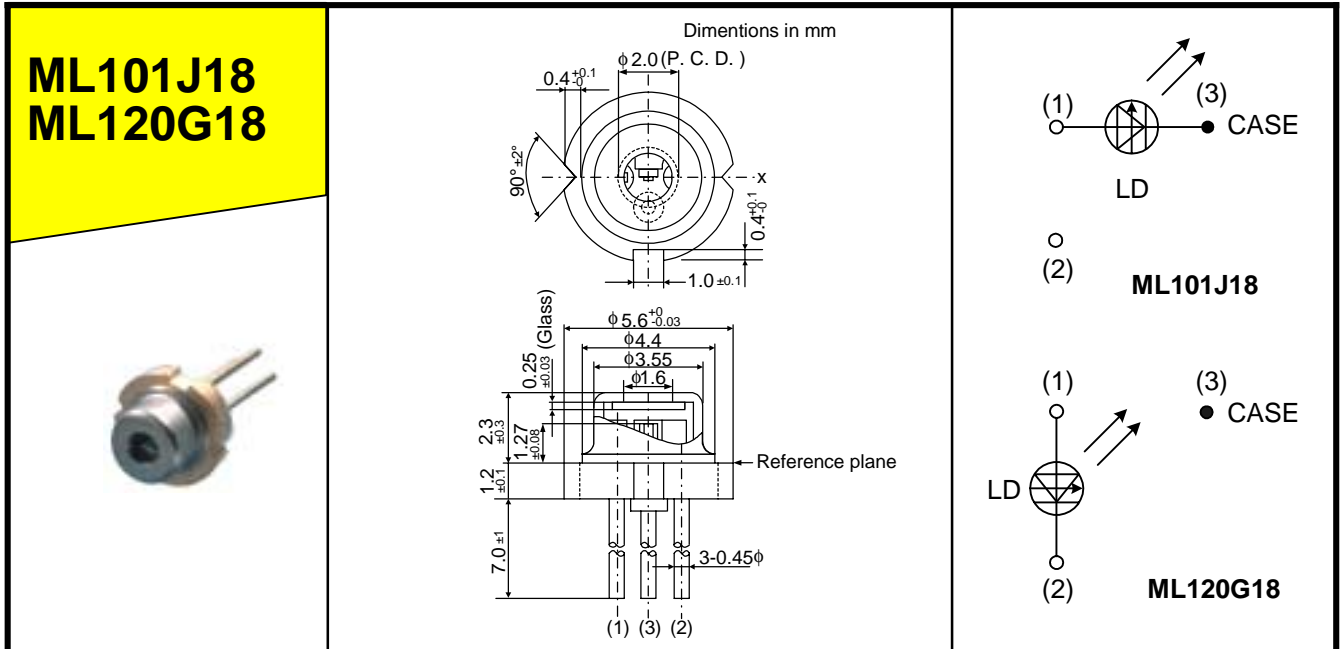

There is no model with a monitor photo diode in ML1XX18 series.

TENTATIVE CHARACTERISTICS (Reference Data)

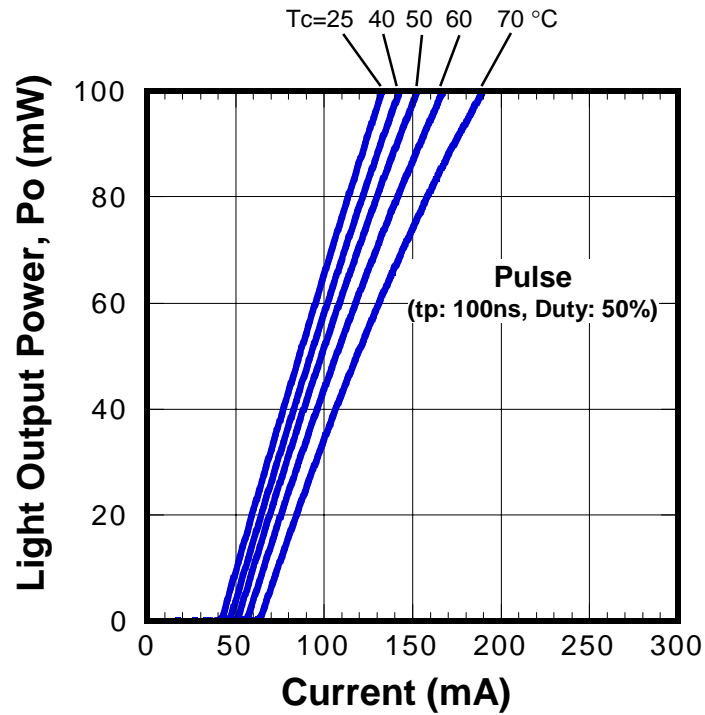

Light Output Power vs. Current (Pulse)

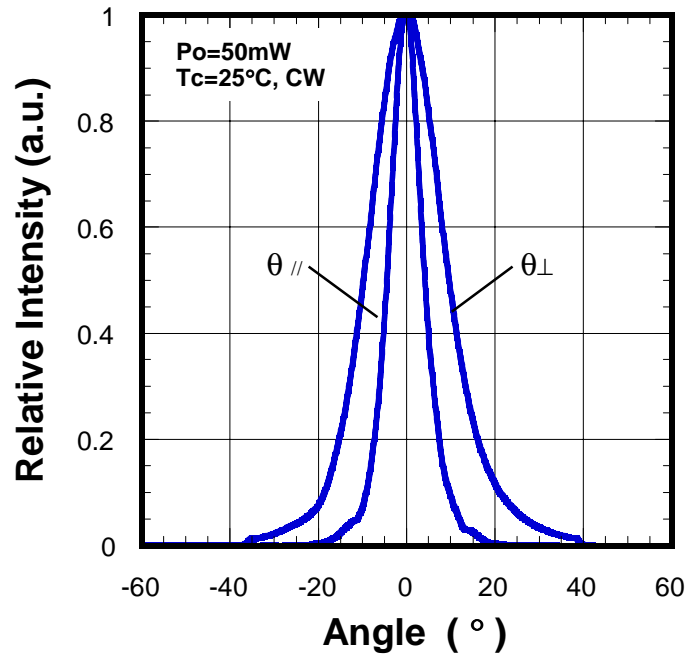

Far Field Patterns