

# Advance Information

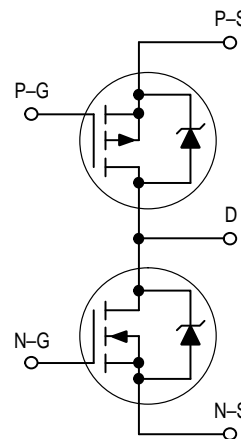
## Medium Power Surface Mount Products

### Complementary TMOS

### Field Effect Transistors

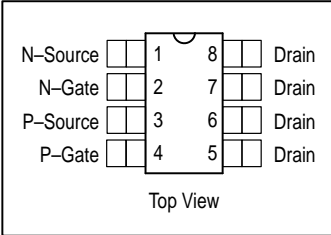
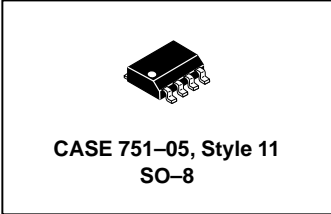
MiniMOS devices are an advanced series of power MOSFETs which utilize Motorola's High Cell Density HDTMOS process. These miniature surface mount MOSFETs feature ultra low  $R_{DS(on)}$  and true logic level performance. They are capable of withstanding high energy in the avalanche and commutation modes and the drain-to-source diode has a very low reverse recovery time. MiniMOS devices are designed for use in low voltage, high speed switching applications where power efficiency is important. Typical applications are dc-dc converters, and power management in portable and battery powered products such as computers, printers, cellular and cordless phones. They can also be used for low voltage motor controls in mass storage products such as disk drives and tape drives.

- Ultra Low  $R_{DS(on)}$  Provides Higher Efficiency and Extends Battery Life
- Logic Level Gate Drive — Can Be Driven by Logic ICs
- Miniature SO-8 Surface Mount Package — Saves Board Space
- Ideal for Synchronous Rectification
- Diode Exhibits High Speed, With Soft Recovery
- $I_{DSS}$  Specified at Elevated Temperature
- Mounting Information for SO-8 Package Provided



**MMDF4C03HD**  
Motorola Preferred Device

**COMPLEMENTARY**  
**DUAL TMOS POWER FET**  
**30 VOLTS**  
N-CH  $R_{DS(on)} = 50 \text{ m}\Omega$   
P-CH  $R_{DS(on)} = 85 \text{ m}\Omega$



**MAXIMUM RATINGS** ( $T_J = 25^\circ\text{C}$  unless otherwise noted)

Rating	Symbol	Polarity	Value	Unit
Drain-to-Source Voltage	$V_{DSS}$	—	30	Vdc
Gate-to-Source Voltage	$V_{GS}$	—	$\pm 20$	Vdc
Drain Current — Continuous	$I_D$	N-Channel	5.5	A dc
		P-Channel	4.4	
Drain Current — Pulsed	$I_{DM}$	N-Channel	25	A pk
		P-Channel	20	
Operating and Storage Temperature Range	$T_J, T_{stg}$	—	-55 to +150	$^\circ\text{C}$
Total Power Dissipation @ $T_A = 25^\circ\text{C}$ (1)	$P_D$		2.5	Watts
Single Pulse Drain-to-Source Avalanche Energy — Starting $T_J = 25^\circ\text{C}$ ( $V_{DD} = 30 \text{ Vdc}$ , $V_{GS} = 5.0 \text{ Vdc}$ , $I_L = 9.0 \text{ Apk}$ , $L = 10 \text{ mH}$ , $R_G = 25 \Omega$ ) ( $V_{DD} = 30 \text{ Vdc}$ , $V_{GS} = 5.0 \text{ Vdc}$ , $I_L = 9.0 \text{ Apk}$ , $L = 10 \text{ mH}$ , $R_G = 25 \Omega$ )	$E_{AS}$	N-Channel	325	mJ
		P-Channel	450	
Thermal Resistance — Junction-to-Ambient (1)	$R_{\theta JA}$		50	$^\circ\text{C/W}$
Maximum Lead Temperature for Soldering Purposes, 1/8" from Case for 10 sec.	$T_L$		260	$^\circ\text{C}$

**DEVICE MARKING**

D4C03

(1) Mounted on G10/FR4 glass epoxy board using minimum recommended footprint.

**ORDERING INFORMATION**

Device	Reel Size	Tape Width	Quantity
MMDF4C03HDR2	13"	12 mm embossed tape	2500

This document contains information on a new product. Specifications and information herein are subject to change without notice. HDTMOS and MiniMOS are trademarks of Motorola, Inc. TMOS is a registered trademark of Motorola, Inc. Thermal Clad is a trademark of the Bergquist Company.

Preferred devices are Motorola recommended choices for future use and best overall value.

REV 1

# M MDF4C03HD

## ELECTRICAL CHARACTERISTICS (T<sub>A</sub> = 25°C unless otherwise noted)

Characteristic	Symbol	Polarity	Min	Typ	Max	Unit
<b>OFF CHARACTERISTICS</b>						
Drain-to-Source Breakdown Voltage (V <sub>GS</sub> = 0 Vdc, I <sub>D</sub> = 0.25 mAdc)	V <sub>(BR)DSS</sub>	—	30	—	—	Vdc
Zero Gate Voltage Drain Current (V <sub>DS</sub> = 30 Vdc, V <sub>GS</sub> = 0 Vdc)	I <sub>DSS</sub>	(N) (P)	— —	— —	1.0 1.0	μAdc
Gate-Body Leakage Current (V <sub>GS</sub> = ±20 Vdc, V <sub>DS</sub> = 0)	I <sub>GSS</sub>	—	—	—	±100	nAdc

### ON CHARACTERISTICS(1)

Gate Threshold Voltage (V <sub>DS</sub> = V <sub>GS</sub> , I <sub>D</sub> = 250 μAdc) Threshold Temperature Coefficient (Negative)	V <sub>GS(th)</sub>	— —	1.0 —	— —	— —	Vdc mV/°C
Drain-to-Source On-Resistance (V <sub>GS</sub> = 10 Vdc, I <sub>D</sub> = 3.5 Adc) (V <sub>GS</sub> = 10 Vdc, I <sub>D</sub> = 3.5 Adc)	R <sub>DS(on)1</sub>	(N) (P)	— —	0.037 0.075	0.05 0.085	Ohms
Static Drain-to-Source On-Resistance (V <sub>GS</sub> = 4.5 Vdc, I <sub>D</sub> = 2.5 Adc) (V <sub>GS</sub> = 4.5 Vdc, I <sub>D</sub> = 2.0 Adc)	R <sub>DS(on)2</sub>	(N) (P)	— —	0.55 0.125	0.08 0.16	Ohms
Forward Transconductance (V <sub>DS</sub> = 15 Vdc, I <sub>D</sub> = 3.5 Adc)	g <sub>FS</sub>	(N) (P)	— —	9.0 6.0	— —	mhos

### DYNAMIC CHARACTERISTICS

Input Capacitance	(V <sub>DS</sub> = 24 Vdc, V <sub>GS</sub> = 0 Vdc, f = 1.0 MHz)	C <sub>iss</sub>	(N) (P)	— —	430 425	600 600	pF
Output Capacitance		C <sub>oss</sub>	(N) (P)	— —	217 209	300 300	
Transfer Capacitance		C <sub>rss</sub>	(N) (P)	— —	67.5 57.2	135 80	

### SWITCHING CHARACTERISTICS(2)

Turn-On Delay Time	(V <sub>DD</sub> = 15 Vdc, I <sub>D</sub> = 1.0 Adc, V <sub>GS</sub> = 10 Vdc, R <sub>G</sub> = 6.0 Ω)	t <sub>d(on)</sub>	(N) (P)	— —	8.2 11.7	16.4 23.4	ns
Rise Time		t <sub>r</sub>	(N) (P)	— —	8.48 15.8	16.9 31.6	
Turn-Off Delay Time		t <sub>d(off)</sub>	(N) (P)	— —	89.6 167.3	179 334.6	
Fall Time		t <sub>f</sub>	(N) (P)	— —	61.1 102.6	122 205.2	
Total Gate Charge (See Figure 8)	(V <sub>DS</sub> = 10 Vdc, I <sub>D</sub> = 3.5 Adc, V <sub>GS</sub> = 10 Vdc)	Q <sub>T</sub>	(N) (P)	— —	15.7 14.8	31.4 29.6	nC
		Q <sub>1</sub>	(N) (P)	— —	2.0 1.7	— —	
		Q <sub>2</sub>	(N) (P)	— —	4.6 4.7	— —	
		Q <sub>3</sub>	(N) (P)	— —	3.9 3.4	— —	

### SOURCE-DRAIN DIODE CHARACTERISTICS

Forward On-Voltage(2)	(I <sub>S</sub> = 1.7 Adc, V <sub>GS</sub> = 0 Vdc) (I <sub>S</sub> = -1.7 Adc, V <sub>GS</sub> = 0 Vdc)	V <sub>SD</sub>	(N) (P)	— —	0.77 0.90	1.2 1.2	Vdc
Reverse Recovery Time	(N) (I <sub>D</sub> = 3.5 Adc, V <sub>GS</sub> = 0 Vdc dI <sub>S</sub> /dt = 100 A/μs)	t <sub>rr</sub>	(N) (P)	— —	54.5 77.4	— —	ns
		t <sub>a</sub>	(N) (P)	— —	14.8 19.9	— —	
		t <sub>b</sub>	(N) (P)	— —	39.7 57.5	— —	
Reverse Recovery Stored Charge	(P) (I <sub>D</sub> = 3.5 Adc, V <sub>GS</sub> = 0 Vdc dI <sub>S</sub> /dt = 100 A/μs)	Q <sub>RR</sub>	(N) (P)	— —	0.048 0.088	— —	μC

(1) Pulse Test: Pulse Width ≤ 300 μs, Duty Cycle ≤ 2%.

(2) Switching characteristics are independent of operating junction temperature.

TYPICAL ELECTRICAL CHARACTERISTICS

N-Channel

P-Channel

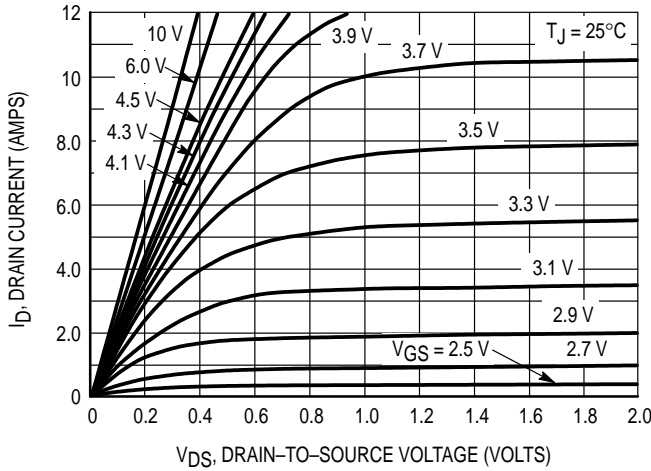


Figure 1. On-Region Characteristics

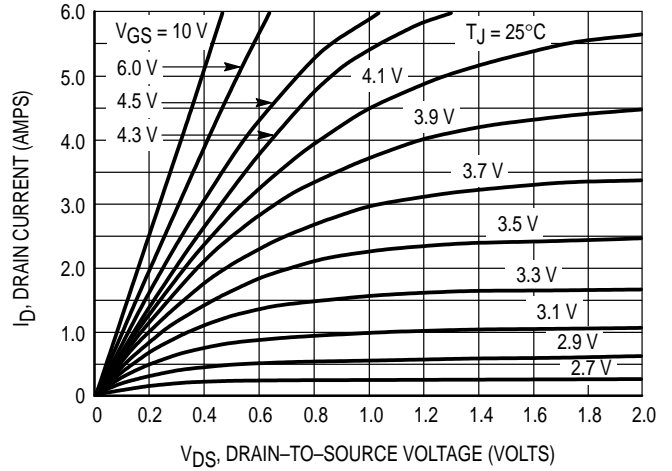


Figure 1. On-Region Characteristics

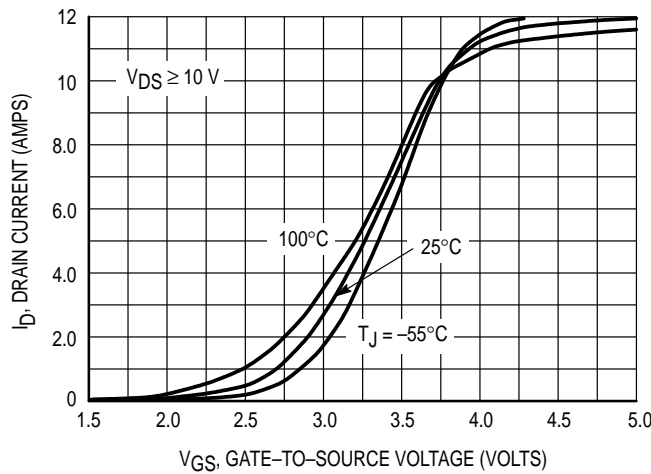


Figure 2. Transfer Characteristics

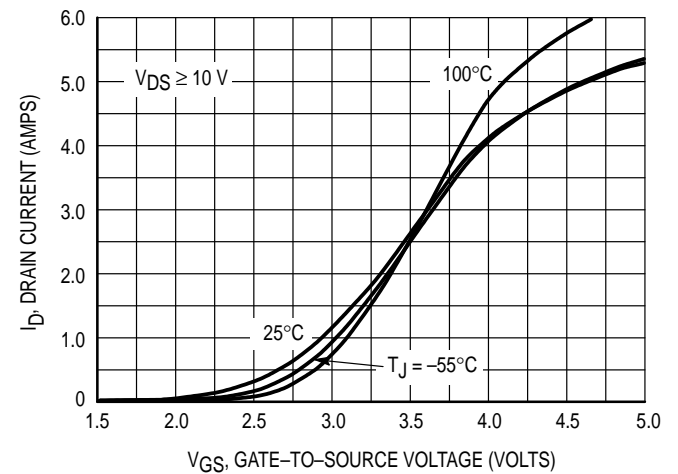


Figure 2. Transfer Characteristics

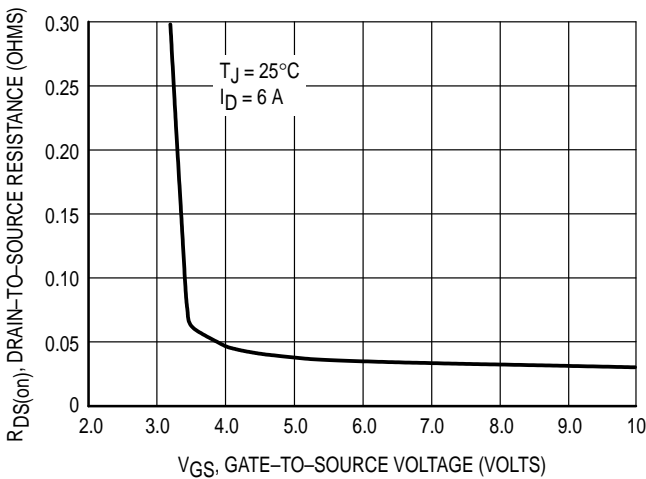


Figure 3. On-Resistance versus Gate-to-Source Voltage

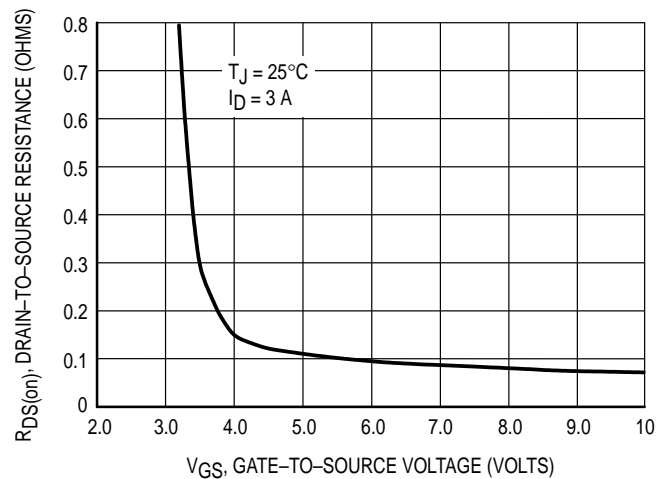


Figure 3. On-Resistance versus Gate-to-Source Voltage

TYPICAL ELECTRICAL CHARACTERISTICS

N-Channel

P-Channel

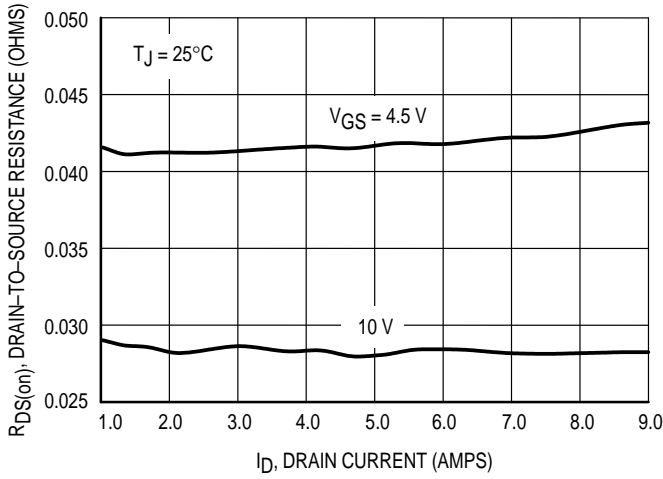


Figure 4. On-Resistance versus Drain Current and Gate Voltage

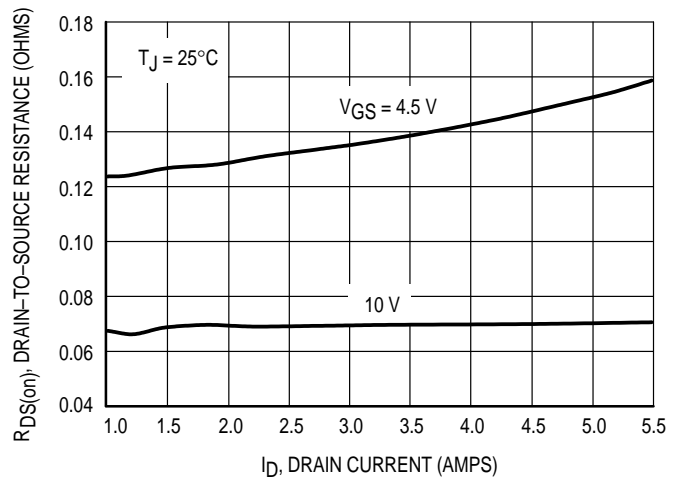


Figure 4. On-Resistance versus Drain Current and Gate Voltage

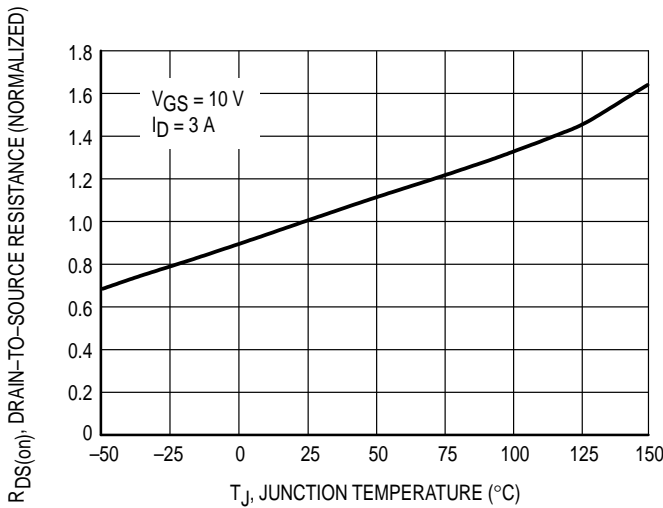


Figure 5. On-Resistance Variation with Temperature

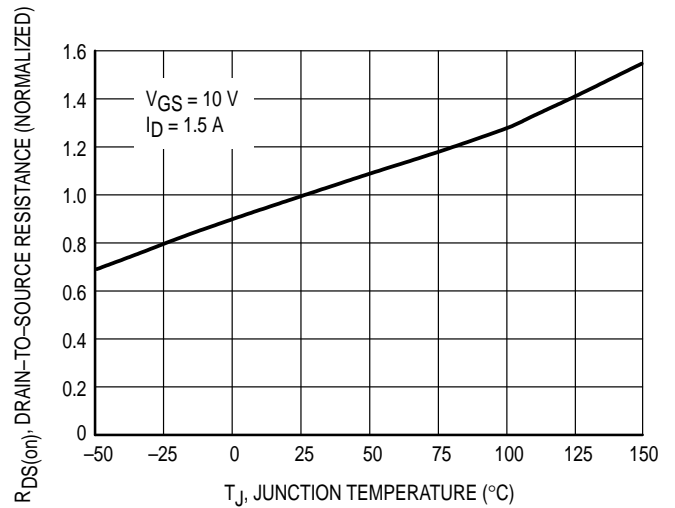


Figure 5. On-Resistance Variation with Temperature

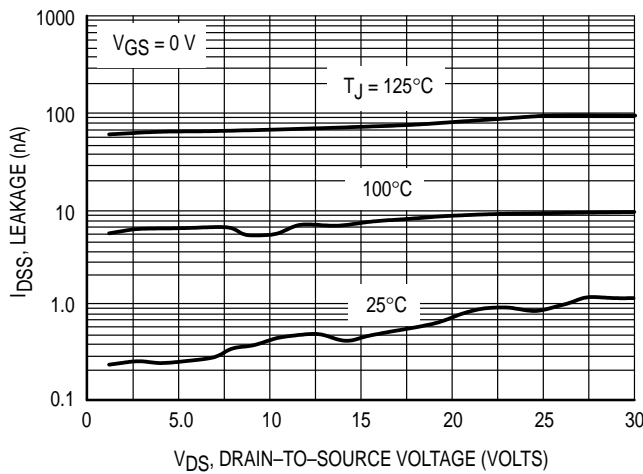


Figure 6. Drain-To-Source Leakage Current versus Voltage

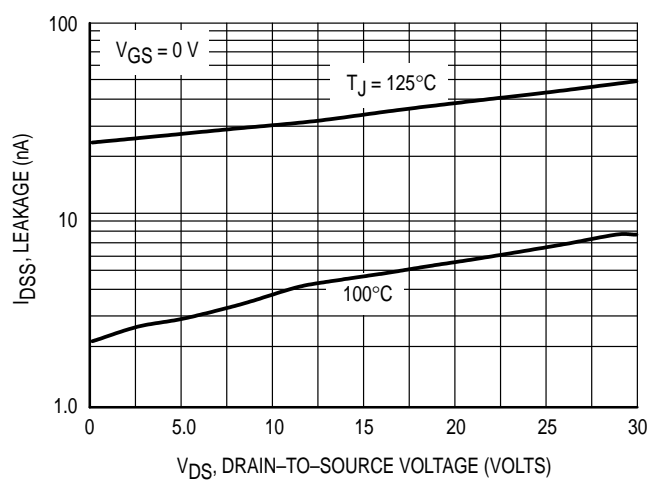


Figure 6. Drain-To-Source Leakage Current versus Voltage

**POWER MOSFET SWITCHING**

Switching behavior is most easily modeled and predicted by recognizing that the power MOSFET is charge controlled. The lengths of various switching intervals ( $\Delta t$ ) are determined by how fast the FET input capacitance can be charged by current from the generator.

The published capacitance data is difficult to use for calculating rise and fall because drain–gate capacitance varies greatly with applied voltage. Accordingly, gate charge data is used. In most cases, a satisfactory estimate of average input current ( $I_{G(AV)}$ ) can be made from a rudimentary analysis of the drive circuit so that

$$t = Q/I_{G(AV)}$$

During the rise and fall time interval when switching a resistive load,  $V_{GS}$  remains virtually constant at a level known as the plateau voltage,  $V_{SGP}$ . Therefore, rise and fall times may be approximated by the following:

$$t_r = Q_2 \times R_G / (V_{GG} - V_{SGP})$$

$$t_f = Q_2 \times R_G / V_{SGP}$$

where

$V_{GG}$  = the gate drive voltage, which varies from zero to  $V_{GG}$

$R_G$  = the gate drive resistance

and  $Q_2$  and  $V_{SGP}$  are read from the gate charge curve.

During the turn–on and turn–off delay times, gate current is not constant. The simplest calculation uses appropriate values from the capacitance curves in a standard equation for voltage change in an RC network. The equations are:

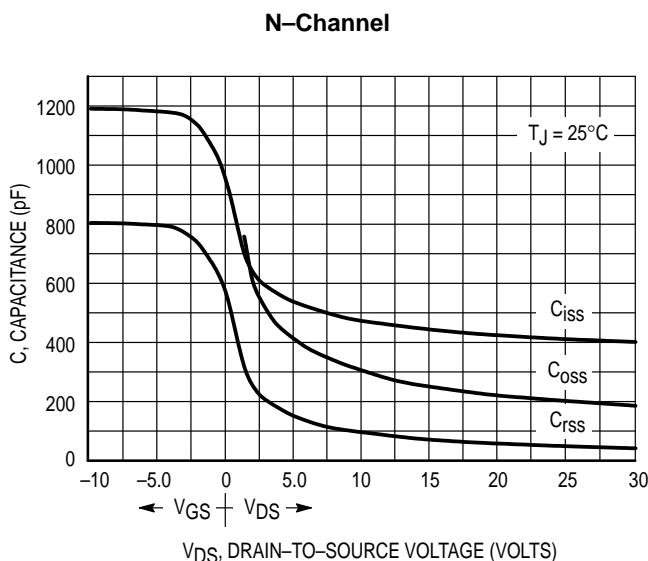
$$t_{d(on)} = R_G C_{iss} \ln [V_{GG} / (V_{GG} - V_{SGP})]$$

$$t_{d(off)} = R_G C_{iss} \ln (V_{GG} / V_{SGP})$$

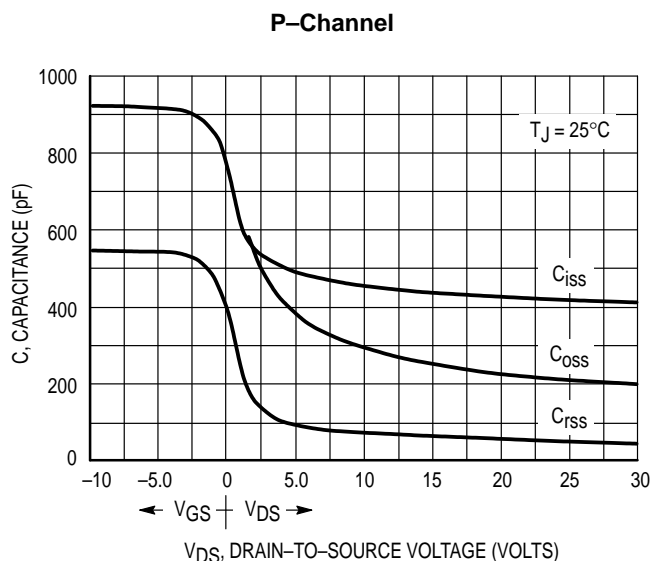
The capacitance ( $C_{iss}$ ) is read from the capacitance curve at a voltage corresponding to the off–state condition when calculating  $t_{d(on)}$  and is read at a voltage corresponding to the on–state when calculating  $t_{d(off)}$ .

At high switching speeds, parasitic circuit elements complicate the analysis. The inductance of the MOSFET source lead, inside the package and in the circuit wiring which is common to both the drain and gate current paths, produces a voltage at the source which reduces the gate drive current. The voltage is determined by  $L di/dt$ , but since  $di/dt$  is a function of drain current, the mathematical solution is complex. The MOSFET output capacitance also complicates the mathematics. And finally, MOSFETs have finite internal gate resistance which effectively adds to the resistance of the driving source, but the internal resistance is difficult to measure and, consequently, is not specified.

The resistive switching time variation versus gate resistance (Figure 9) shows how typical switching performance is affected by the parasitic circuit elements. If the parasitics were not present, the slope of the curves would maintain a value of unity regardless of the switching speed. The circuit used to obtain the data is constructed to minimize common inductance in the drain and gate circuit loops and is believed readily achievable with board mounted components. Most power electronic loads are inductive; the data in the figure is taken with a resistive load, which approximates an optimally snubbed inductive load. Power MOSFETs may be safely operated into an inductive load; however, snubbing reduces switching losses.

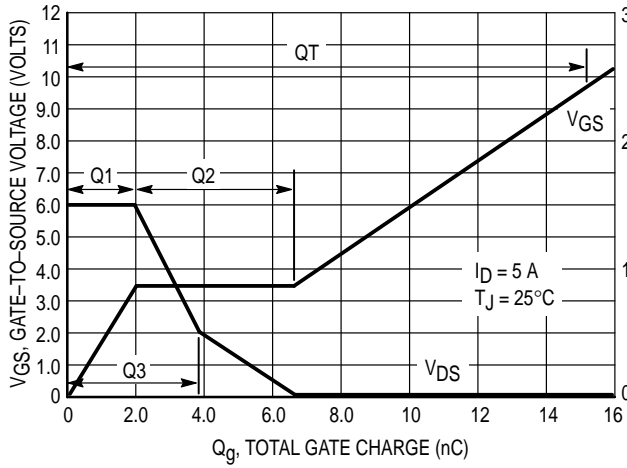


**Figure 7. Capacitance Variation**

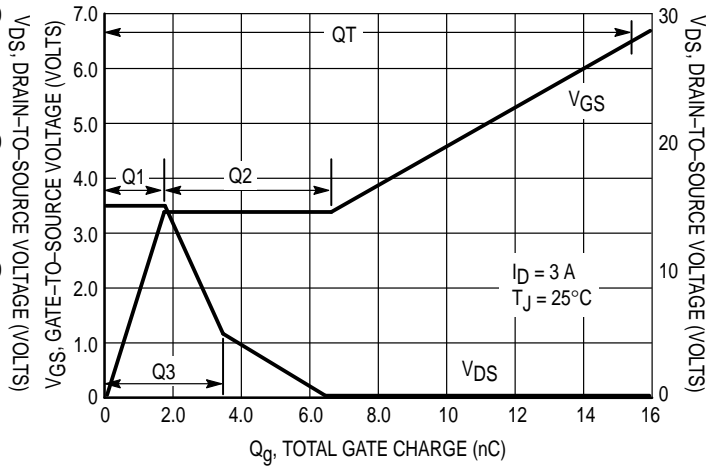


**Figure 7. Capacitance Variation**

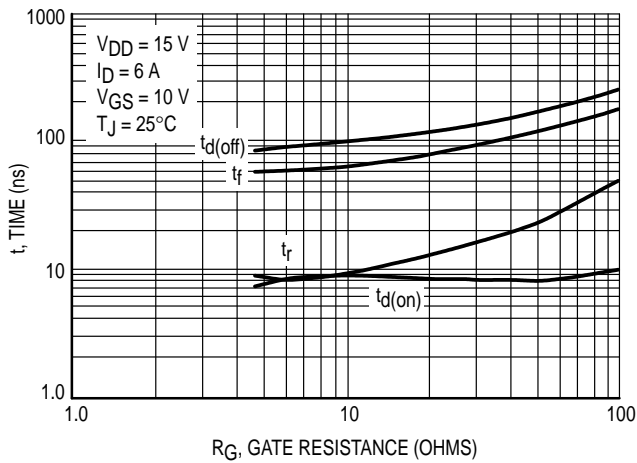
# M MDF4C03HD



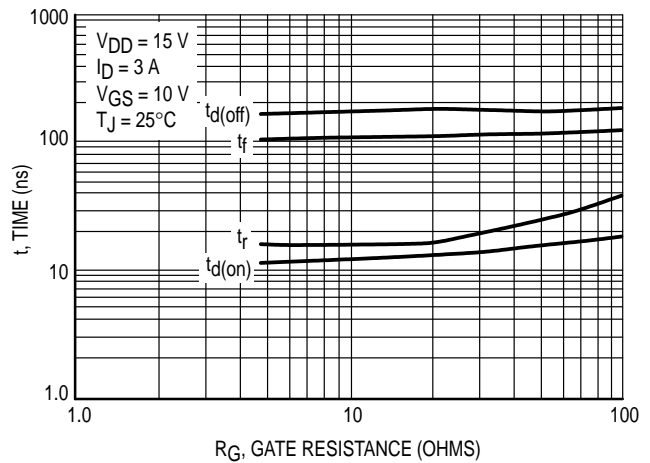
**Figure 8. Gate-To-Source and Drain-To-Source Voltage versus Total Charge**



**Figure 8. Gate-To-Source and Drain-To-Source Voltage versus Total Charge**



**Figure 9. Resistive Switching Time Variation versus Gate Resistance**



**Figure 9. Resistive Switching Time Variation versus Gate Resistance**

### DRAIN-TO-SOURCE DIODE CHARACTERISTICS

The switching characteristics of a MOSFET body diode are very important in systems using it as a freewheeling or commutating diode. Of particular interest are the reverse recovery characteristics which play a major role in determining switching losses, radiated noise, EMI and RFI.

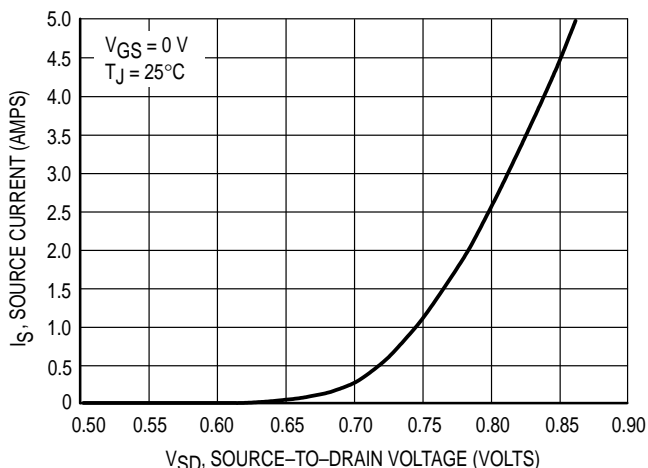
System switching losses are largely due to the nature of the body diode itself. The body diode is a minority carrier device, therefore it has a finite reverse recovery time,  $t_{rr}$ , due to the storage of minority carrier charge,  $Q_{RR}$ , as shown in the typical reverse recovery wave form of Figure 15. It is this stored charge that, when cleared from the diode, passes through a potential and defines an energy loss. Obviously, repeatedly forcing the diode through reverse recovery further increases switching losses. Therefore, one would like a diode with short  $t_{rr}$  and low  $Q_{RR}$  specifications to minimize these losses.

The abruptness of diode reverse recovery effects the amount of radiated noise, voltage spikes, and current ringing. The mechanisms at work are finite irremovable circuit parasitic inductances and capacitances acted upon by high

$di/dt$ s. The diode's negative  $di/dt$  during  $t_a$  is directly controlled by the device clearing the stored charge. However, the positive  $di/dt$  during  $t_b$  is an uncontrollable diode characteristic and is usually the culprit that induces current ringing. Therefore, when comparing diodes, the ratio of  $t_b/t_a$  serves as a good indicator of recovery abruptness and thus gives a comparative estimate of probable noise generated. A ratio of 1 is considered ideal and values less than 0.5 are considered snappy.

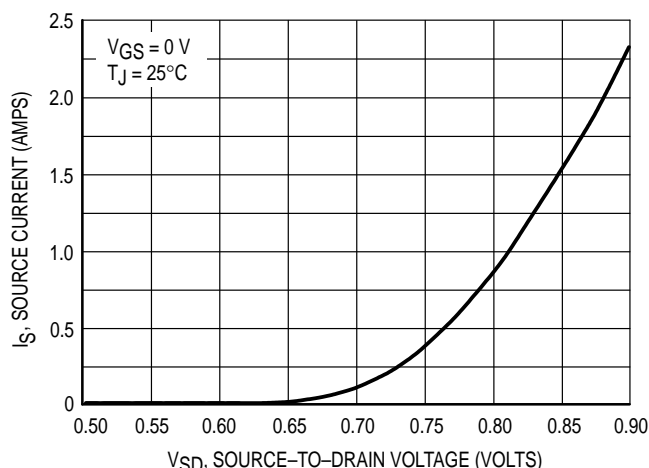
Compared to Motorola standard cell density low voltage MOSFETs, high cell density MOSFET diodes are faster (shorter  $t_{rr}$ ), have less stored charge and a softer reverse recovery characteristic. The softness advantage of the high cell density diode means they can be forced through reverse recovery at a higher  $di/dt$  than a standard cell MOSFET diode without increasing the current ringing or the noise generated. In addition, power dissipation incurred from switching the diode will be less due to the shorter recovery time and lower switching losses.

**N-Channel**



**Figure 10. Diode Forward Voltage versus Current**

**P-Channel**



**Figure 10. Diode Forward Voltage versus Current**

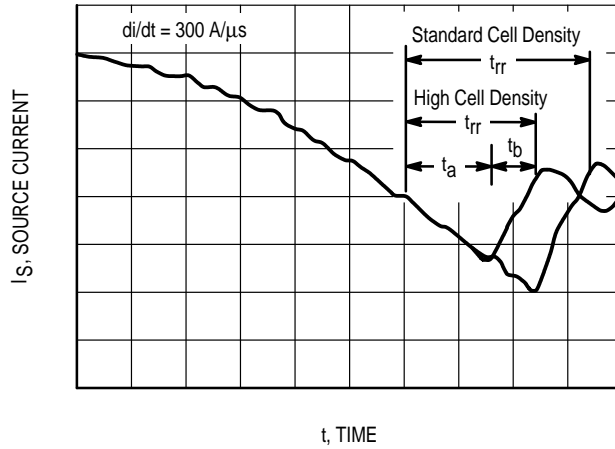


Figure 11. Reverse Recovery Time ( $t_{rr}$ )

**SAFE OPERATING AREA**

The Forward Biased Safe Operating Area curves define the maximum simultaneous drain-to-source voltage and drain current that a transistor can handle safely when it is forward biased. Curves are based upon maximum peak junction temperature and a case temperature ( $T_C$ ) of  $25^\circ\text{C}$ . Peak repetitive pulsed power limits are determined by using the thermal response data in conjunction with the procedures discussed in AN569, "Transient Thermal Resistance – General Data and Its Use."

Switching between the off-state and the on-state may traverse any load line provided neither rated peak current ( $I_{DM}$ ) nor rated voltage ( $V_{DSS}$ ) is exceeded, and that the transition time ( $t_r$ ,  $t_f$ ) does not exceed  $10 \mu\text{s}$ . In addition the total power averaged over a complete switching cycle must not exceed  $(T_{J(\text{MAX})} - T_C)/(R_{\theta\text{JC}})$ .

A power MOSFET designated E-FET can be safely used in switching circuits with unclamped inductive loads. For reli-

able operation, the stored energy from circuit inductance dissipated in the transistor while in avalanche must be less than the rated limit and must be adjusted for operating conditions differing from those specified. Although industry practice is to rate in terms of energy, avalanche energy capability is not a constant. The energy rating decreases non-linearly with an increase of peak current in avalanche and peak junction temperature.

Although many E-FETs can withstand the stress of drain-to-source avalanche at currents up to rated pulsed current ( $I_{DM}$ ), the energy rating is specified at rated continuous current ( $I_D$ ), in accordance with industry custom. The energy rating must be derated for temperature as shown in the accompanying graph (Figure 13). Maximum energy at currents below rated continuous  $I_D$  can safely be assumed to equal the values indicated.

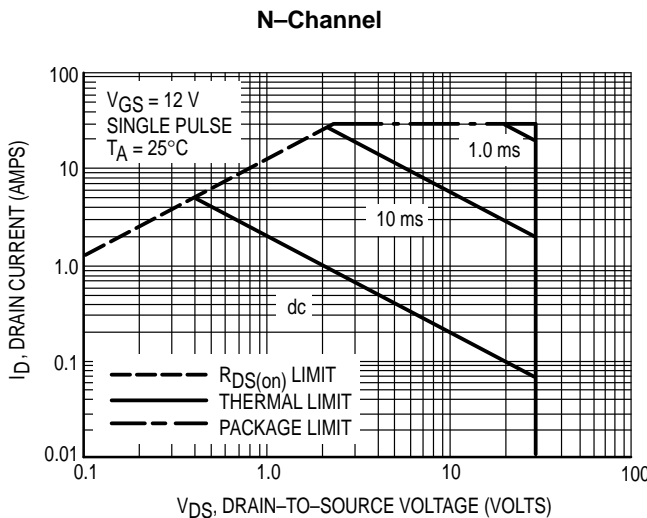


Figure 12. Maximum Rated Forward Biased Safe Operating Area

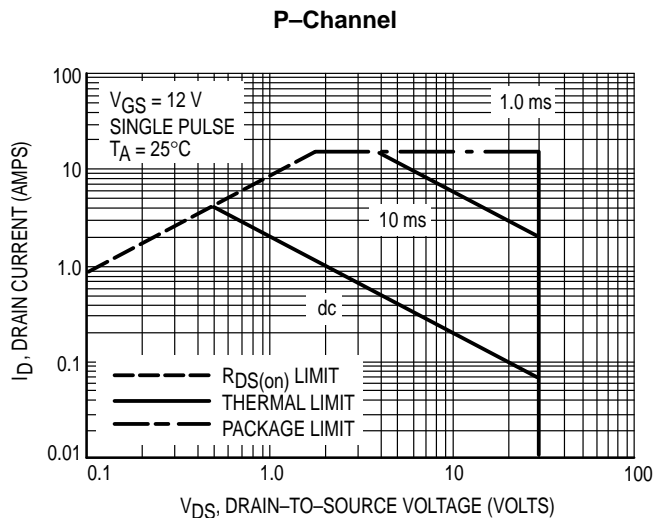


Figure 12. Maximum Rated Forward Biased Safe Operating Area



N-Channel

P-Channel

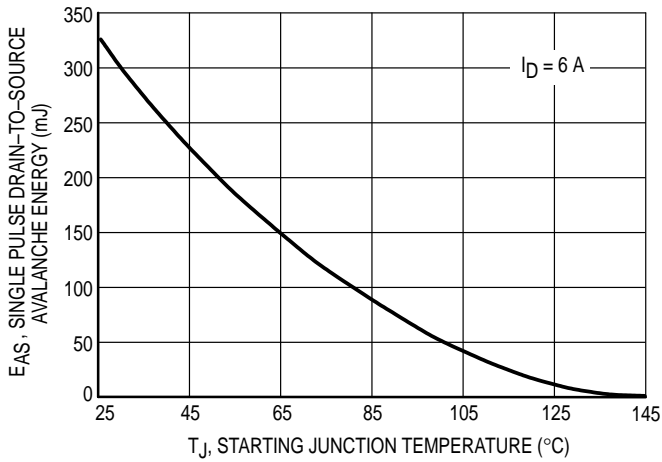


Figure 13. Maximum Avalanche Energy versus Starting Junction Temperature

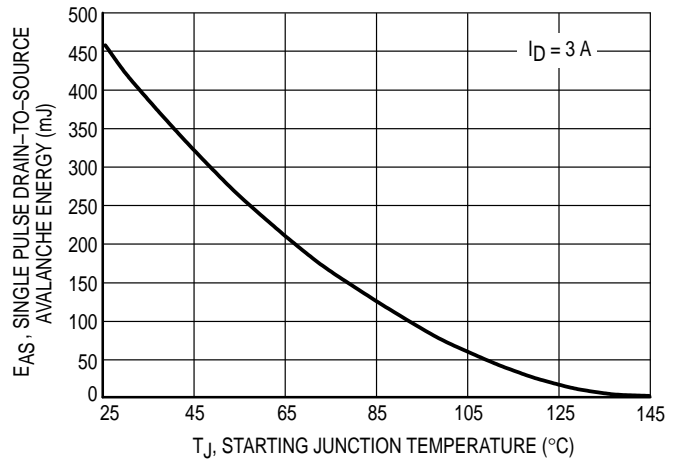


Figure 13. Maximum Avalanche Energy versus Starting Junction Temperature

TYPICAL ELECTRICAL CHARACTERISTICS

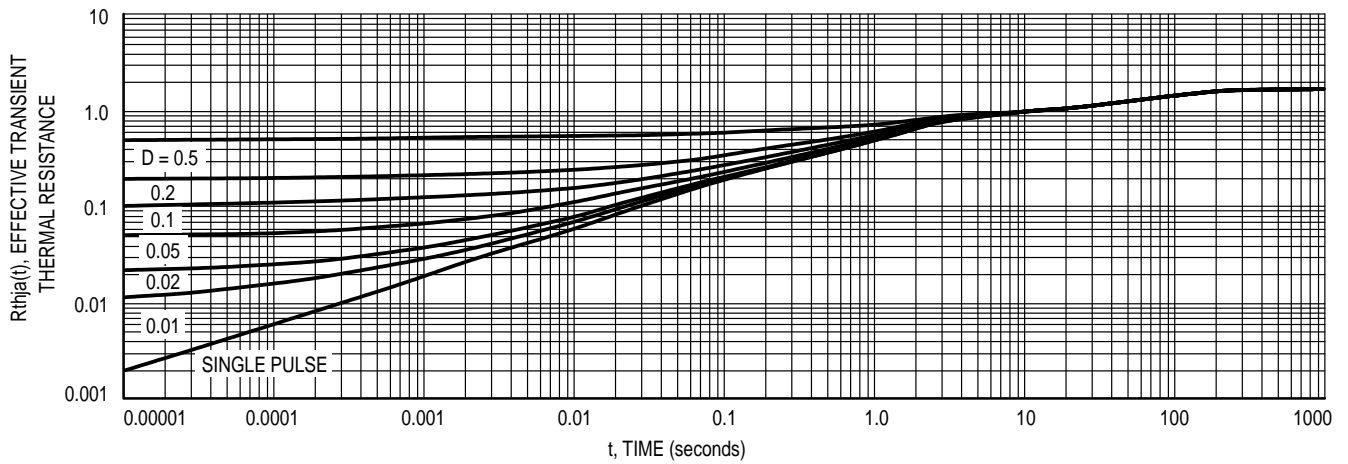


Figure 14. Thermal Response

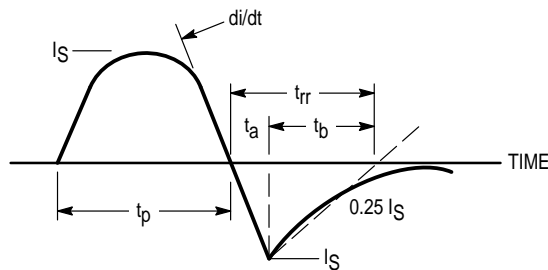


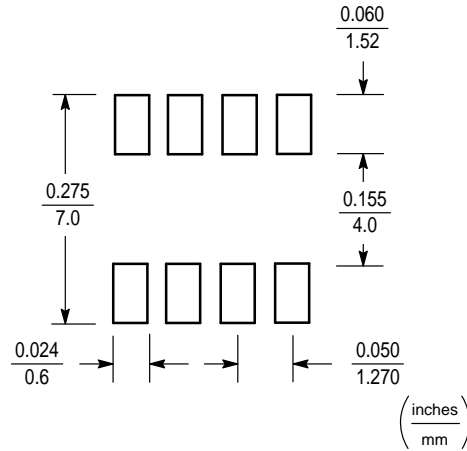
Figure 15. Diode Reverse Recovery Waveform

**INFORMATION FOR USING THE SO-8 SURFACE MOUNT PACKAGE**

**MINIMUM RECOMMENDED FOOTPRINT FOR SURFACE MOUNTED APPLICATIONS**

Surface mount board layout is a critical portion of the total design. The footprint for the semiconductor packages must be the correct size to ensure proper solder connection interface

between the board and the package. With the correct pad geometry, the packages will self-align when subjected to a solder reflow process.



**SO-8 POWER DISSIPATION**

The power dissipation of the SO-8 is a function of the input pad size. This can vary from the minimum pad size for soldering to the pad size given for maximum power dissipation. Power dissipation for a surface mount device is determined by  $T_{J(max)}$ , the maximum rated junction temperature of the die,  $R_{\theta JA}$ , the thermal resistance from the device junction to ambient; and the operating temperature,  $T_A$ . Using the values provided on the data sheet for the SO-8 package,  $P_D$  can be calculated as follows:

the equation for an ambient temperature  $T_A$  of 25°C, one can calculate the power dissipation of the device which in this case is 2.0 Watts.

$$P_D = \frac{T_{J(max)} - T_A}{R_{\theta JA}}$$

$$P_D = \frac{150^\circ\text{C} - 25^\circ\text{C}}{62.5^\circ\text{C/W}} = 2.0 \text{ Watts}$$

The values for the equation are found in the maximum ratings table on the data sheet. Substituting these values into

The 62.5°C/W for the SO-8 package assumes the recommended footprint on a glass epoxy printed circuit board to achieve a power dissipation of 2.0 Watts using the footprint shown. Another alternative would be to use a ceramic substrate or an aluminum core board such as Thermal Clad™. Using board material such as Thermal Clad, the power dissipation can be doubled using the same footprint.

**SOLDERING PRECAUTIONS**

The melting temperature of solder is higher than the rated temperature of the device. When the entire device is heated to a high temperature, failure to complete soldering within a short time could result in device failure. Therefore, the following items should always be observed in order to minimize the thermal stress to which the devices are subjected.

- The soldering temperature and time shall not exceed 260°C for more than 10 seconds.
- When shifting from preheating to soldering, the maximum temperature gradient shall be 5°C or less.
- After soldering has been completed, the device should be allowed to cool naturally for at least three minutes. Gradual cooling should be used as the use of forced cooling will increase the temperature gradient and result in latent failure due to mechanical stress.
- Mechanical stress or shock should not be applied during cooling.

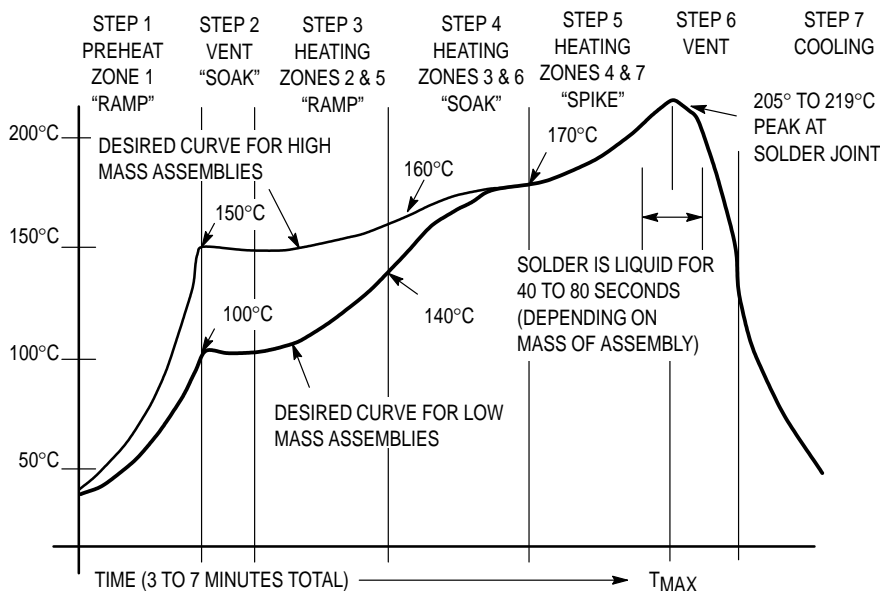
- Always preheat the device.
- The delta temperature between the preheat and soldering should be 100°C or less.\*
- When preheating and soldering, the temperature of the leads and the case must not exceed the maximum temperature ratings as shown on the data sheet. When using infrared heating with the reflow soldering method, the difference shall be a maximum of 10°C.

\* Soldering a device without preheating can cause excessive thermal shock and stress which can result in damage to the device.

**TYPICAL SOLDER HEATING PROFILE**

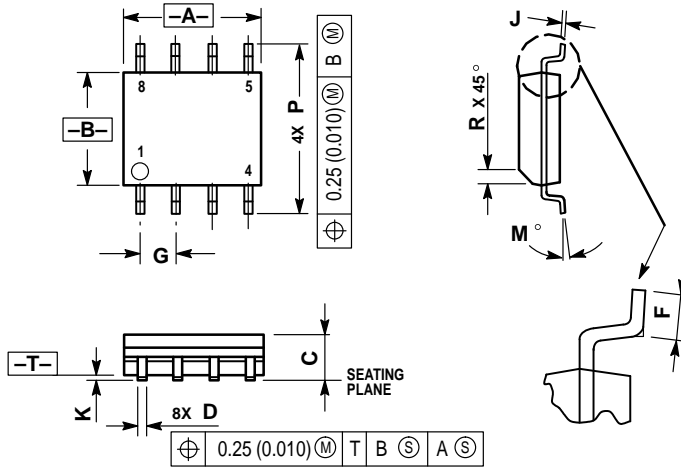
For any given circuit board, there will be a group of control settings that will give the desired heat pattern. The operator must set temperatures for several heating zones and a figure for belt speed. Taken together, these control settings make up a heating "profile" for that particular circuit board. On machines controlled by a computer, the computer remembers these profiles from one operating session to the next. Figure 16 shows a typical heating profile for use when soldering a surface mount device to a printed circuit board. This profile will vary among soldering systems, but it is a good starting point. Factors that can affect the profile include the type of soldering system in use, density and types of components on the board, type of solder used, and the type of board or substrate material being used. This profile shows temperature versus time. The

line on the graph shows the actual temperature that might be experienced on the surface of a test board at or near a central solder joint. The two profiles are based on a high density and a low density board. The Vitronics SMD310 convection/infrared reflow soldering system was used to generate this profile. The type of solder used was 62/36/2 Tin Lead Silver with a melting point between 177–189°C. When this type of furnace is used for solder reflow work, the circuit boards and solder joints tend to heat first. The components on the board are then heated by conduction. The circuit board, because it has a large surface area, absorbs the thermal energy more efficiently, then distributes this energy to the components. Because of this effect, the main body of a component may be up to 30 degrees cooler than the adjacent solder joints.



**Figure 16. Typical Solder Heating Profile**

**PACKAGE DIMENSIONS**



- NOTES:
1. DIMENSIONS A AND B ARE DATUMS AND T IS A DATUM SURFACE.
  2. DIMENSIONING AND TOLERANCING PER ANSI Y14.5M, 1982.
  3. DIMENSIONS ARE IN MILLIMETER.
  4. DIMENSION A AND B DO NOT INCLUDE MOLD PROTRUSION.
  5. MAXIMUM MOLD PROTRUSION 0.15 PER SIDE.
  6. DIMENSION D DOES NOT INCLUDE MOLD PROTRUSION. ALLOWABLE DAMBAR PROTRUSION SHALL BE 0.127 TOTAL IN EXCESS OF THE D DIMENSION AT MAXIMUM MATERIAL CONDITION.

DIM	MILLIMETERS	
	MIN	MAX
A	4.80	5.00
B	3.80	4.00
C	1.35	1.75
D	0.35	0.49
F	0.40	1.25
G	1.27 BSC	
J	0.18	0.25
K	0.10	0.25
M	0°	7°
P	5.80	6.20
R	0.25	0.50

- STYLE 14:
- PIN 1. N-SOURCE
  - 2. N-GATE
  - 3. P-SOURCE
  - 4. P-GATE
  - 5. P-DRAIN
  - 6. P-DRAIN
  - 7. N-DRAIN
  - 8. N-DRAIN

**CASE 751-05  
SO-8  
ISSUE P**

Motorola reserves the right to make changes without further notice to any products herein. Motorola makes no warranty, representation or guarantee regarding the suitability of its products for any particular purpose, nor does Motorola assume any liability arising out of the application or use of any product or circuit, and specifically disclaims any and all liability, including without limitation consequential or incidental damages. "Typical" parameters which may be provided in Motorola data sheets and/or specifications can and do vary in different applications and actual performance may vary over time. All operating parameters, including "Typicals" must be validated for each customer application by customer's technical experts. Motorola does not convey any license under its patent rights nor the rights of others. Motorola products are not designed, intended, or authorized for use as components in systems intended for surgical implant into the body, or other applications intended to support or sustain life, or for any other application in which the failure of the Motorola product could create a situation where personal injury or death may occur. Should Buyer purchase or use Motorola products for any such unintended or unauthorized application, Buyer shall indemnify and hold Motorola and its officers, employees, subsidiaries, affiliates, and distributors harmless against all claims, costs, damages, and expenses, and reasonable attorney fees arising out of, directly or indirectly, any claim of personal injury or death associated with such unintended or unauthorized use, even if such claim alleges that Motorola was negligent regarding the design or manufacture of the part. Motorola and are registered trademarks of Motorola, Inc. Motorola, Inc. is an Equal Opportunity/Affirmative Action Employer.

Mfax is a trademark of Motorola, Inc.

**How to reach us:**

**USA/EUROPE/Locations Not Listed:** Motorola Literature Distribution; P.O. Box 5405, Denver, Colorado 80217. 303-675-2140 or 1-800-441-2447

**JAPAN:** Nippon Motorola Ltd.; Tatsumi-SPD-JLDC, 6F Seibu-Butsuryu-Center, 3-14-2 Tatsumi Koto-Ku, Tokyo 135, Japan. 81-3-3521-8315

**Mfax™:** RMFAX0@email.sps.mot.com – TOUCHTONE 602-244-6609  
– US & Canada ONLY 1-800-774-1848

**ASIA/PACIFIC:** Motorola Semiconductors H.K. Ltd.; 8B Tai Ping Industrial Park, 51 Ting Kok Road, Tai Po, N.T., Hong Kong. 852-26629298

**INTERNET:** <http://motorola.com/sps>

