



RF Power Field Effect Transistors

N-Channel Enhancement-Mode Lateral MOSFETs

Designed for CDMA base station applications with frequencies from 2110 to 2170 MHz. Suitable for CDMA and multicarrier amplifier applications. To be used in Class AB and Class C for PCN - PCS/cellular radio and WLL applications.

- Typical Single-Carrier W-CDMA Performance: $V_{DD} = 28$ Volts, $I_{DQ} = 1400$ mA, $P_{out} = 50$ Watts Avg., Full Frequency Band, 3GPP Test Model 1, 64 DPCH with 50% Clipping, Channel Bandwidth = 3.84 MHz, Input Signal PAR = 7.5 dB @ 0.01% Probability on CCDF.
 Power Gain — 16 dB
 Drain Efficiency — 31%
 Device Output Signal PAR — 6.1 dB @ 0.01% Probability on CCDF
 ACPR @ 5 MHz Offset — -37 dBc in 3.84 MHz Channel Bandwidth
- Capable of Handling 5:1 VSWR, @ 32 Vdc, 2140 MHz, 170 Watts CW Peak Tuned Output Power
- P_{out} @ 1 dB Compression Point ≥ 170 Watts CW

Features

- 100% PAR Tested for Guaranteed Output Power Capability
- Characterized with Series Equivalent Large-Signal Impedance Parameters
- Internally Matched for Ease of Use
- Integrated ESD Protection
- Greater Negative Gate-Source Voltage Range for Improved Class C Operation
- Designed for Digital Predistortion Error Correction Systems
- RoHS Compliant
- In Tape and Reel. R3 Suffix = 250 Units per 56 mm, 13 inch Reel.

MRF7S21170HR3
MRF7S21170HSR3

2110-2170 MHz, 50 W AVG., 28 V
SINGLE W-CDMA
LATERAL N-CHANNEL
RF POWER MOSFETs

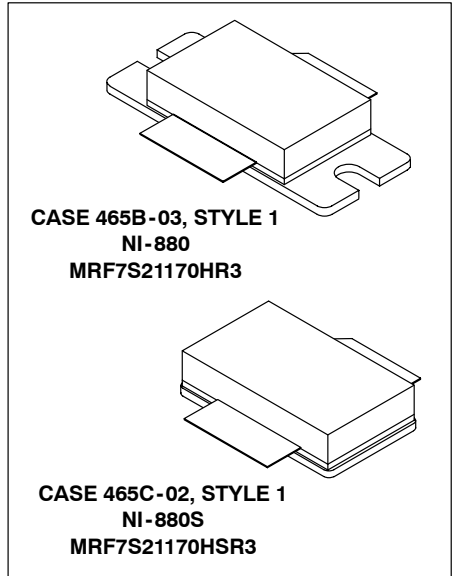

Table 1. Maximum Ratings

Rating	Symbol	Value	Unit
Drain-Source Voltage	V_{DSS}	-0.5, +65	Vdc
Gate-Source Voltage	V_{GS}	-6.0, +10	Vdc
Operating Voltage	V_{DD}	32, +0	Vdc
Storage Temperature Range	T_{stg}	- 65 to +150	°C
Case Operating Temperature	T_C	150	°C
Operating Junction Temperature	T_J	200	°C

Table 2. Thermal Characteristics

Characteristic	Symbol	Value (1,2)	Unit
Thermal Resistance, Junction to Case	$R_{\theta JC}$		°C/W
Case Temperature 80°C, 170 W CW		0.31	
Case Temperature 73°C, 25 W CW		0.36	

1. MTTF calculator available at <http://www.freescale.com/rf>. Select Tools/Software/Application Software/Calculators to access the MTTF calculators by product.
2. Refer to AN1955, *Thermal Measurement Methodology of RF Power Amplifiers*. Go to <http://www.freescale.com/rf>. Select Documentation/Application Notes - AN1955.

Table 3. ESD Protection Characteristics

Test Methodology	Class
Human Body Model (per JESD22-A114)	1A (Minimum)
Machine Model (per EIA/JESD22-A115)	B (Minimum)
Charge Device Model (per JESD22-C101)	IV (Minimum)

Table 4. Electrical Characteristics ($T_C = 25^\circ\text{C}$ unless otherwise noted)

Characteristic	Symbol	Min	Typ	Max	Unit
----------------	--------	-----	-----	-----	------

Off Characteristics

Zero Gate Voltage Drain Leakage Current ($V_{DS} = 65\text{ Vdc}$, $V_{GS} = 0\text{ Vdc}$)	I_{DSS}	—	—	10	μAdc
Zero Gate Voltage Drain Leakage Current ($V_{DS} = 28\text{ Vdc}$, $V_{GS} = 0\text{ Vdc}$)	I_{DSS}	—	—	1	μAdc
Gate-Source Leakage Current ($V_{GS} = 5\text{ Vdc}$, $V_{DS} = 0\text{ Vdc}$)	I_{GSS}	—	—	500	nAdc

On Characteristics

Gate Threshold Voltage ($V_{DS} = 10\text{ Vdc}$, $I_D = 270\ \mu\text{Adc}$)	$V_{GS(th)}$	1	2	3	Vdc
Gate Quiescent Voltage (1) ($V_{DS} = 28\text{ Vdc}$, $I_D = 1400\text{ mAdc}$, Measured in Functional Test)	$V_{GS(Q)}$	2	2.8	4	Vdc
Drain-Source On-Voltage ($V_{GS} = 10\text{ Vdc}$, $I_D = 2.7\text{ Adc}$)	$V_{DS(on)}$	0.1	0.15	0.3	Vdc

Dynamic Characteristics (2)

Reverse Transfer Capacitance ($V_{DS} = 28\text{ Vdc} \pm 30\text{ mV(rms)ac}$ @ 1 MHz, $V_{GS} = 0\text{ Vdc}$)	C_{rss}	—	0.9	—	pF
Output Capacitance ($V_{DS} = 28\text{ Vdc} \pm 30\text{ mV(rms)ac}$ @ 1 MHz, $V_{GS} = 0\text{ Vdc}$)	C_{oss}	—	703	—	pF

Functional Tests (In Freescale Test Fixture, 50 ohm system) $V_{DD} = 28\text{ Vdc}$, $I_{DQ} = 1400\text{ mA}$, $P_{out} = 50\text{ W Avg.}$, $f = 2112.5\text{ MHz}$ and $f = 2167.5\text{ MHz}$, Single-Carrier W-CDMA, 3GPP Test Model 1, 64 DPCH, 50% Clipping, PAR = 7.5 dB @ 0.01% Probability on CCDF. ACPR measured in 3.84 MHz Channel Bandwidth @ $\pm 5\text{ MHz}$ Offset.

Power Gain	G_{ps}	15	16	18	dB
Drain Efficiency	η_D	29	31	—	%
Output Peak-to-Average Ratio @ 0.01% Probability on CCDF	PAR	5.7	6.1	—	dB
Adjacent Channel Power Ratio	ACPR	—	-37	-35	dBc
Input Return Loss	IRL	—	-15	-9	dB

Typical Performances (In Freescale Test Fixture, 50 ohm system) $V_{DD} = 28\text{ Vdc}$, $I_{DQ} = 1400\text{ mA}$, 2110-2170 MHz Bandwidth

Video Bandwidth (Tone Spacing from 100 kHz to VBW) $\Delta\text{IMD3} = \text{IMD3 @ VBW frequency} - \text{IMD3 @ } 100\text{ kHz} < 1\text{ dBc}$ (both sidebands)	VBW	—	25	—	MHz
Gain Flatness in 60 MHz Bandwidth @ $P_{out} = 170\text{ W CW}$	G_F	—	0.4	—	dB
Deviation from Linear Phase in 60 MHz Bandwidth @ $P_{out} = 170\text{ W CW}$	Φ	—	1.95	—	$^\circ$
Group Delay @ $P_{out} = 170\text{ W CW}$, $f = 2140\text{ MHz}$	Delay	—	1.7	—	ns
Part-to-Part Insertion Phase Variation @ $P_{out} = 170\text{ W CW}$	$\Delta\Phi$	—	18	—	$^\circ$
Gain Variation over Temperature	ΔG	—	0.015	—	dB/ $^\circ\text{C}$
Output Power Variation over Temperature	ΔP_{1dB}	—	0.01	—	dBm/ $^\circ\text{C}$

1. $V_{GG} = 2 \times V_{GS(Q)}$. Parameter measured on Freescale Test Fixture, due to resistive divider network on the board. Refer to Test Circuit schematic.
2. Part internally matched both on input and output.

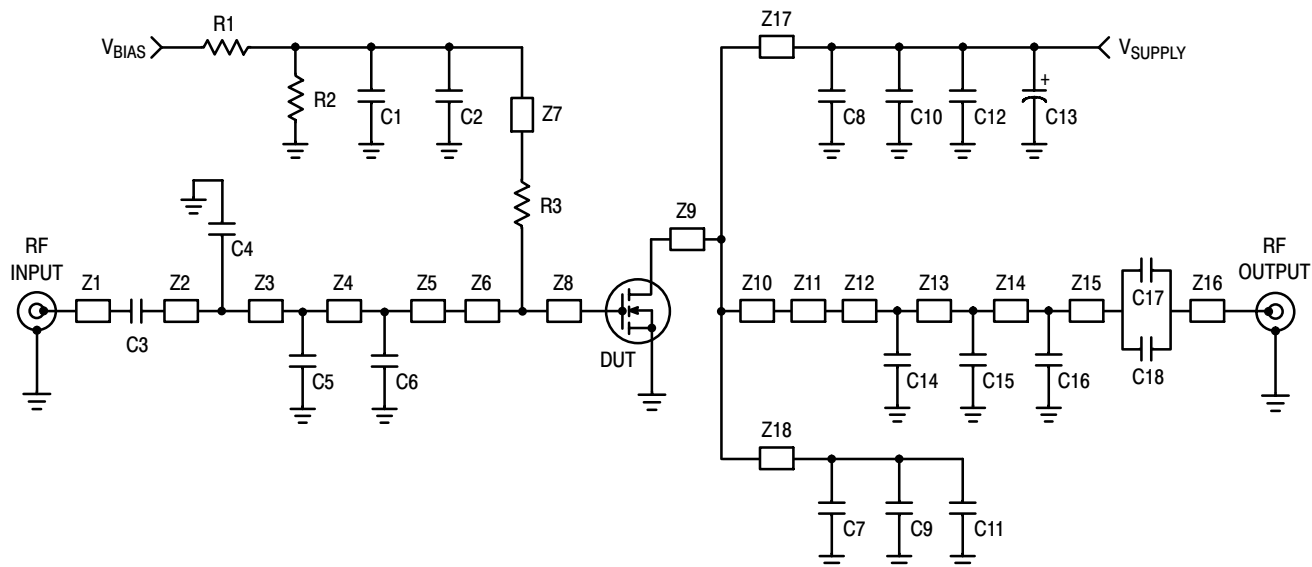

Z1	0.250" x 0.083" Microstrip	Z11	0.060" x 0.760" Microstrip
Z2*	0.090" x 0.083" Microstrip	Z12*	0.129" x 0.083" Microstrip
Z3*	0.842" x 0.083" Microstrip	Z13*	0.436" x 0.083" Microstrip
Z4*	0.379" x 0.083" Microstrip	Z14*	0.490" x 0.083" Microstrip
Z5*	0.307" x 0.083" Microstrip	Z15*	0.275" x 0.083" Microstrip
Z6	0.156" x 0.787" Microstrip	Z16	0.230" x 0.083" Microstrip
Z7	1.160" x 0.080" Microstrip	Z17, Z18	0.900" x 0.080" Microstrip
Z8	0.119" x 0.787" Microstrip	PCB	Taconix TLX8-0300, 0.030", $\epsilon_r = 2.55$
Z9	0.077" x 0.880" Microstrip		
Z10	0.459" x 1.000" Microstrip		

* Variable for tuning

Figure 1. MRF7S21170HR3(HSR3) Test Circuit Schematic

Table 5. MRF7S21170HR3(HSR3) Test Circuit Component Designations and Values

Part	Description	Part Number	Manufacturer
C1	100 pF 100B Chip Capacitor	100B101JW500XT	ATC
C2, C3, C7, C8, C17, C18	6.8 pF 600B Chip Capacitors	600B6R8BT500XT	ATC
C4, C15	0.3 pF 700B Chip Capacitors	700B0R3BW500XT	ATC
C5	0.8 pF 600B Chip Capacitor	600B0R8BT500XT	ATC
C6	0.2 pF 700B Chip Capacitor	700B0R2BW500XT	ATC
C9, C10, C11, C12	10 μ F Chip Capacitors	C5750X5R1H106MT	TDK
C13	470 μ F, 63 V Electrolytic Capacitor, Radial	13661471	Philips
C14	0.4 pF 700B Chip Capacitor	700B0R4BW500XT	ATC
C16	0.1 pF 700B Chip Capacitor	700B0R1BW500XT	ATC
R1, R2	10 k Ω , 1/4 W Chip Resistors	CRCW12061001FKTA	Vishay
R3	10 Ω , 1/4 W Chip Resistor	CRCW120610R0FKTA	Vishay

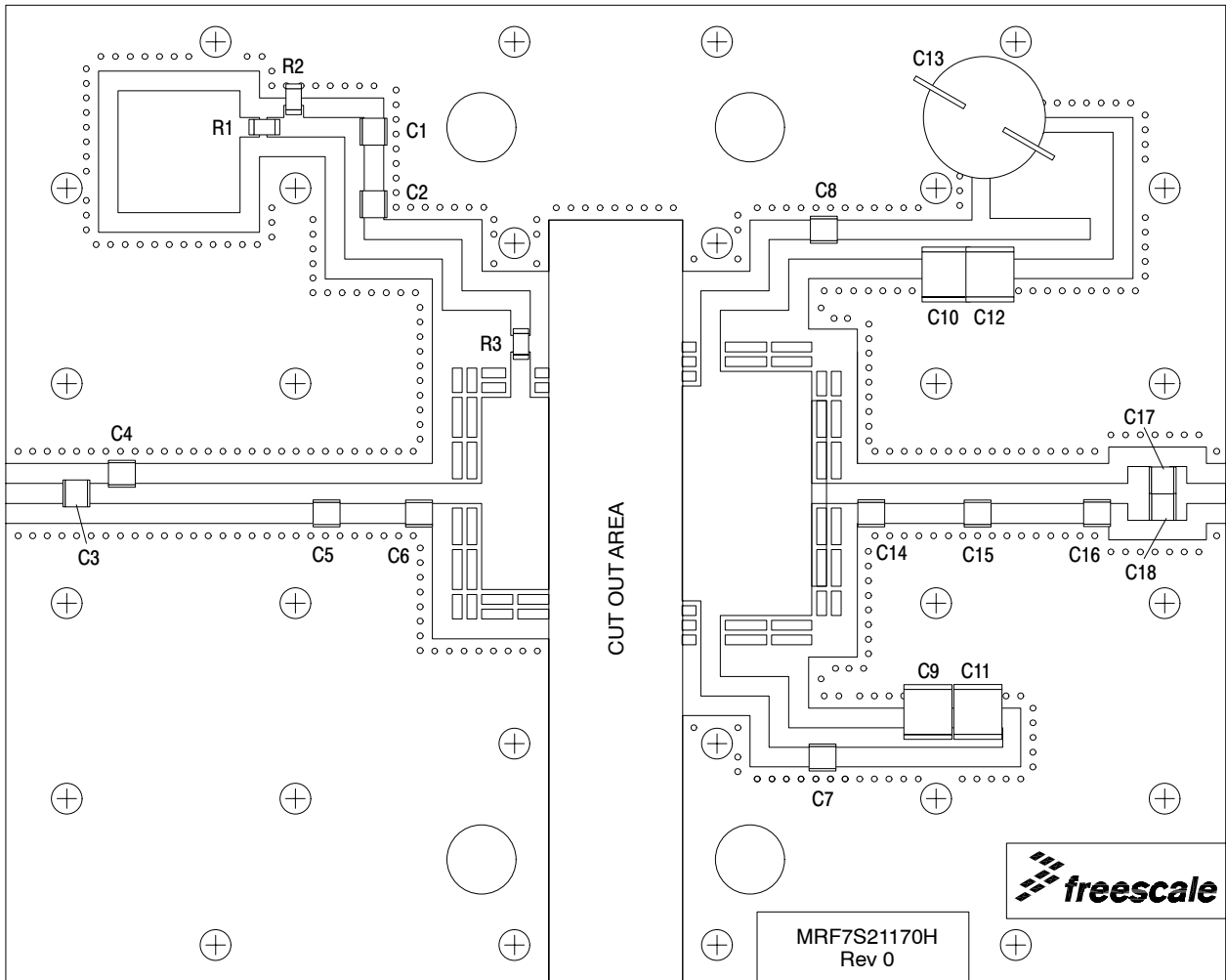

Figure 2. MRF7S21170HR3(HSR3) Test Circuit Component Layout

TYPICAL CHARACTERISTICS

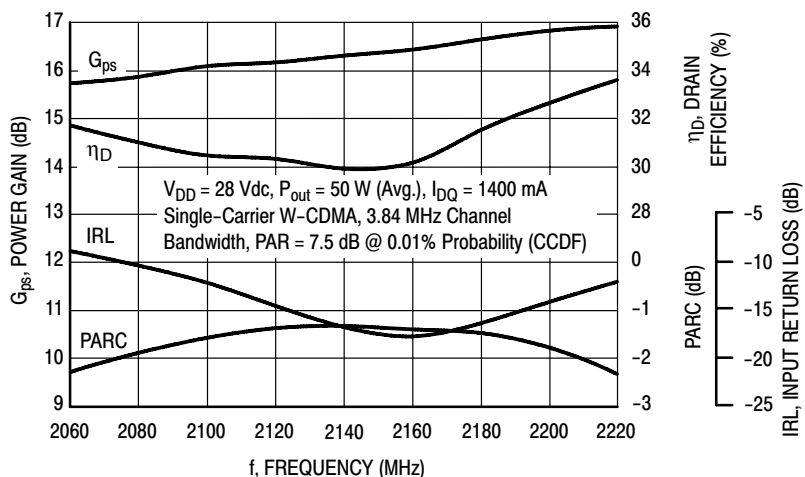

Figure 3. Output Peak-to-Average Ratio Compression (PARC) Broadband Performance @ $P_{out} = 50$ Watts Avg.

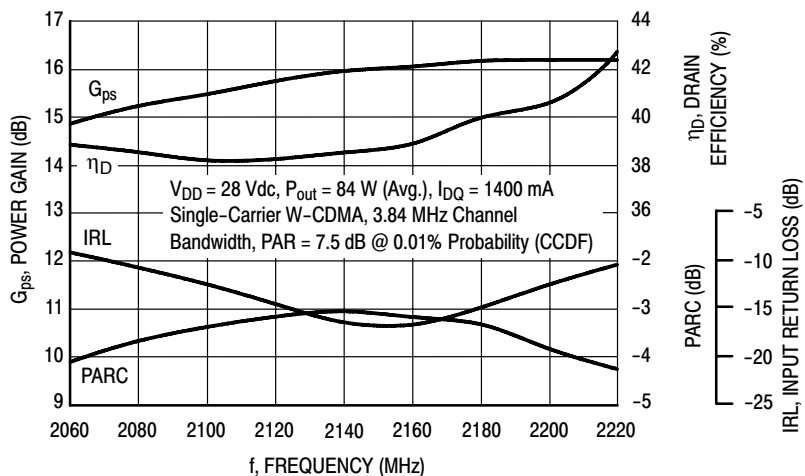

Figure 4. Output Peak-to-Average Ratio Compression (PARC) Broadband Performance @ $P_{out} = 84$ Watts Avg.

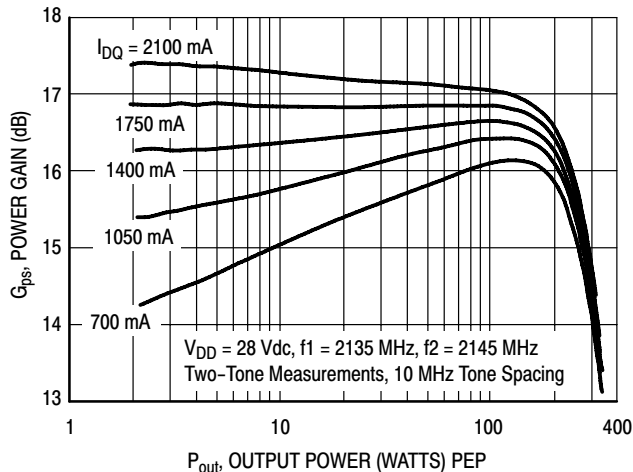

Figure 5. Two-Tone Power Gain versus Output Power

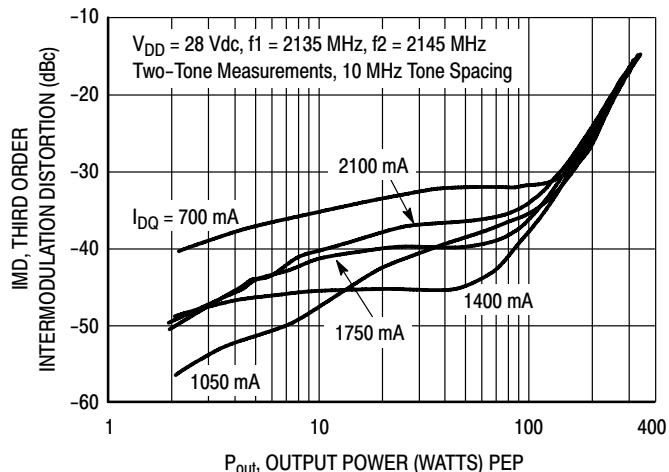

Figure 6. Third Order Intermodulation Distortion versus Output Power

TYPICAL CHARACTERISTICS

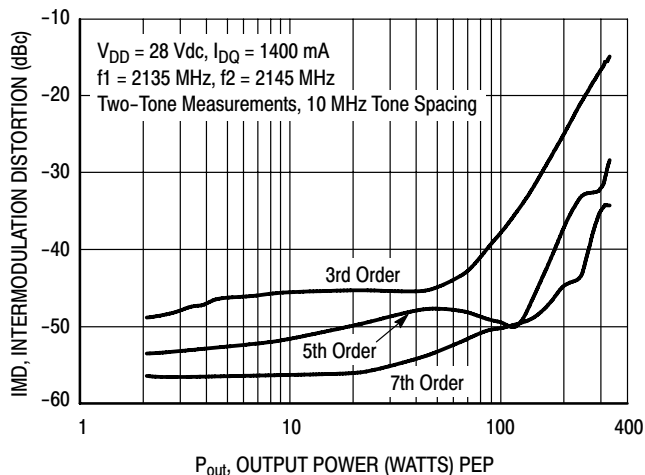

Figure 7. Intermodulation Distortion Products versus Output Power

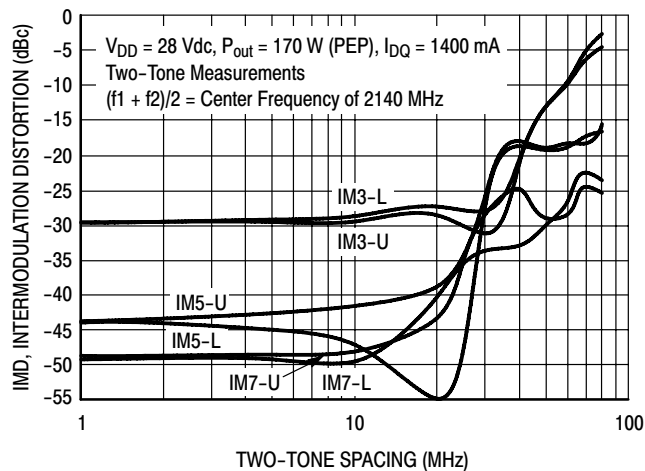

Figure 8. Intermodulation Distortion Products versus Tone Spacing

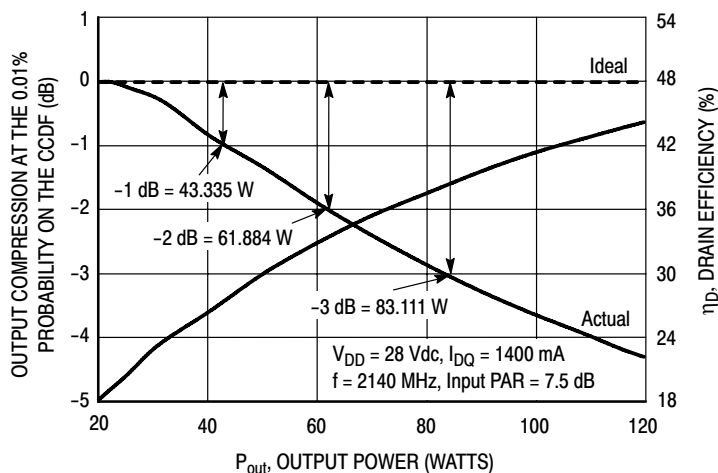

Figure 9. Output Peak-to-Average Ratio Compression (PARC) versus Output Power

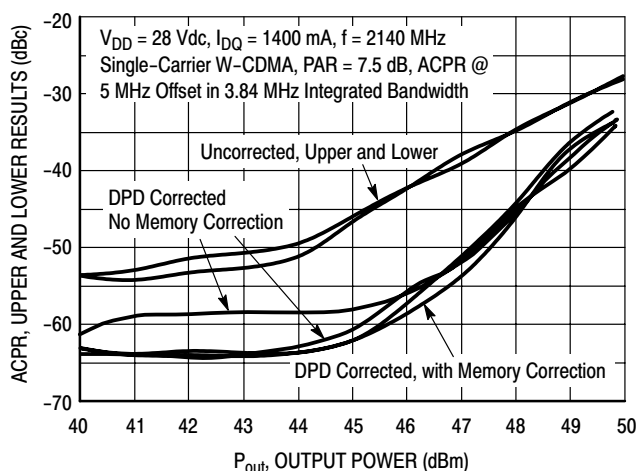

Figure 10. Digital Predistortion Correction versus ACPR and Output Power

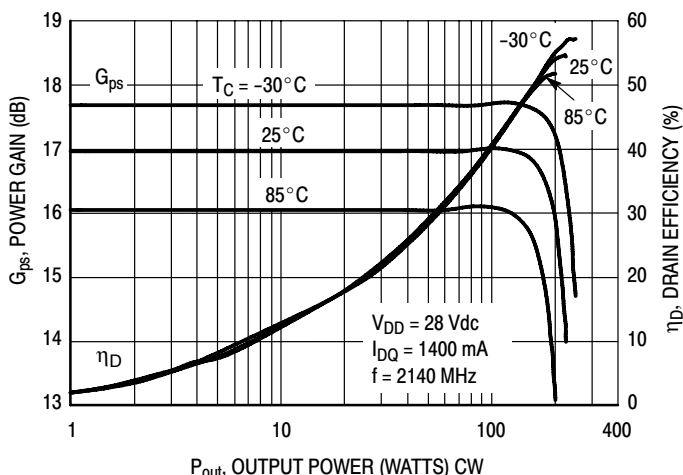

Figure 11. Power Gain and Drain Efficiency versus CW Output Power

TYPICAL CHARACTERISTICS

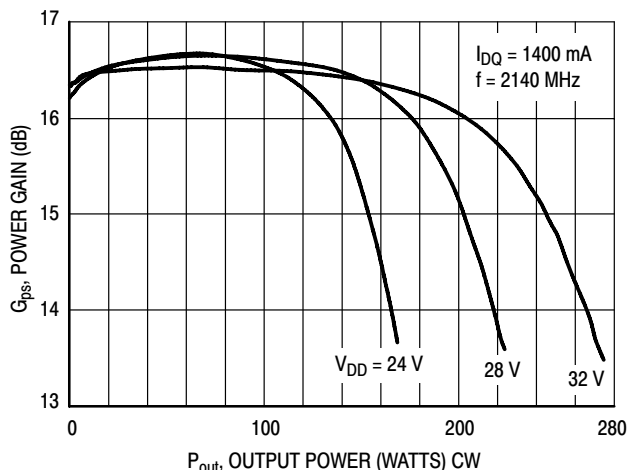
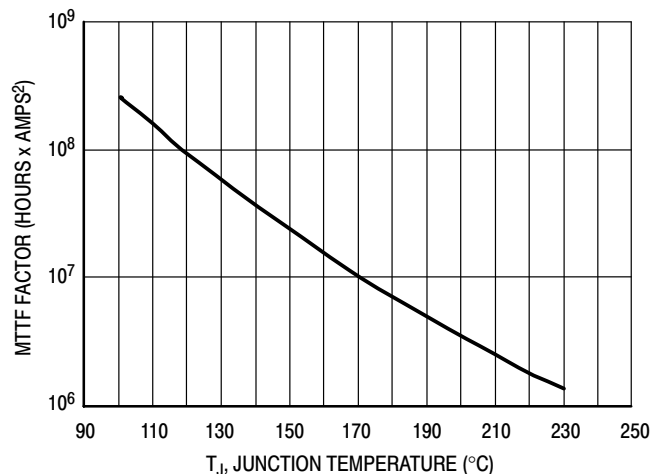

Figure 12. Power Gain versus Output Power



This above graph displays calculated MTTF in hours x ampere² drain current. Life tests at elevated temperatures have correlated to better than $\pm 10\%$ of the theoretical prediction for metal failure. Divide MTTF factor by I_D^2 for MTTF in a particular application.

Figure 13. MTTF Factor versus Junction Temperature

W-CDMA TEST SIGNAL

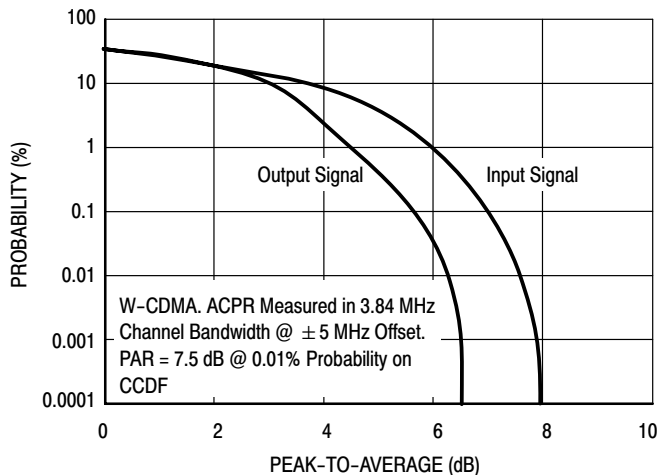

Figure 14. CCDF W-CDMA 3GPP, Test Model 1, 64 DPCH, 50% Clipping, Single-Carrier Test Signal

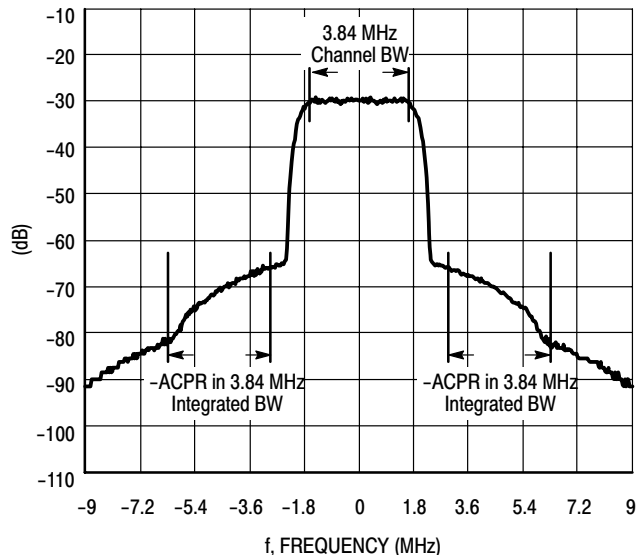
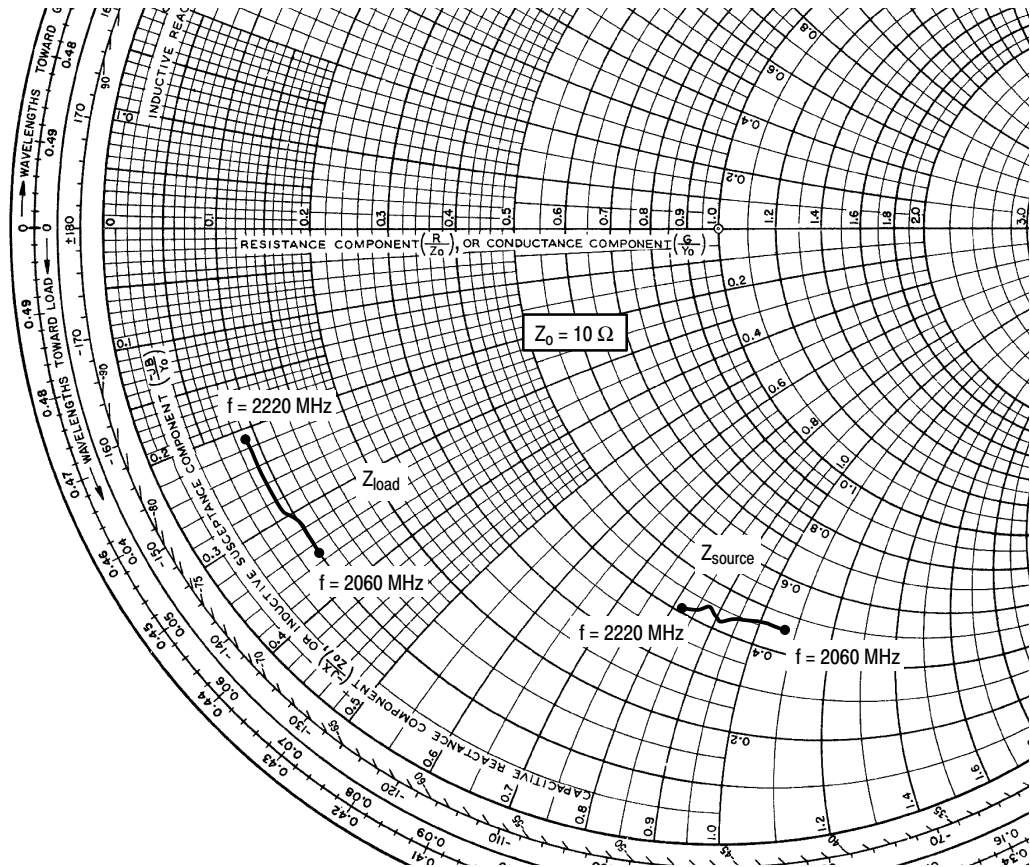

Figure 15. Single-Carrier W-CDMA Spectrum



$V_{DD} = 28 \text{ Vdc}$, $I_{DQ} = 1400 \text{ mA}$, $P_{out} = 50 \text{ W Avg.}$

f MHz	Z_{source} Ω	Z_{load} Ω
2060	$4.57 - j10.70$	$1.02 - j3.54$
2080	$4.57 - j10.38$	$0.99 - j3.34$
2100	$4.57 - j10.06$	$0.96 - j3.14$
2120	$4.52 - j9.72$	$0.93 - j2.94$
2140	$4.40 - j9.42$	$0.92 - j2.76$
2160	$4.15 - j9.12$	$0.91 - j2.59$
2180	$4.44 - j8.82$	$0.89 - j2.42$
2200	$4.19 - j8.53$	$0.88 - j2.25$
2220	$4.12 - j8.23$	$0.88 - j2.09$

Z_{source} = Test circuit impedance as measured from gate to ground.

Z_{load} = Test circuit impedance as measured from drain to ground.

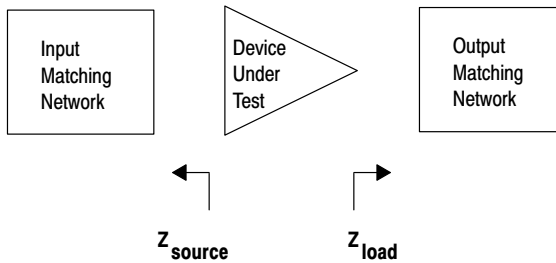
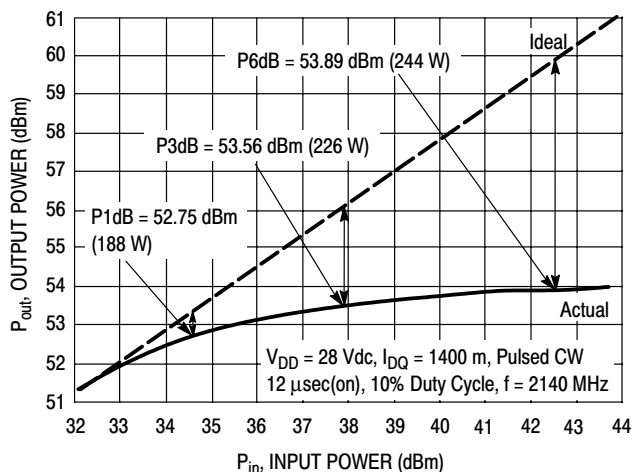

Figure 16. Series Equivalent Source and Load Impedance

ALTERNATIVE PEAK TUNE LOAD PULL CHARACTERISTICS



NOTE: Measured in a Peak Tuned Load Pull Fixture

Test Impedances per Compression Level

	Z_{source} Ω	Z_{load} Ω
P3dB	4.43 - j11.85	0.81 - j2.87

Figure 17. Pulsed CW Output Power versus Input Power

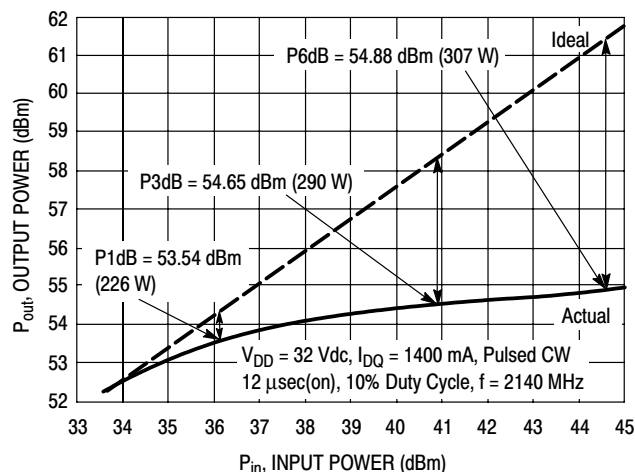

NOTE: Measured in a Peak Tuned Load Pull Fixture

Test Impedances per Compression Level

	Z_{source} Ω	Z_{load} Ω
P3dB	4.43 - j11.85	0.72 - j2.87

Figure 18. Pulsed CW Output Power versus Input Power

PACKAGE DIMENSIONS

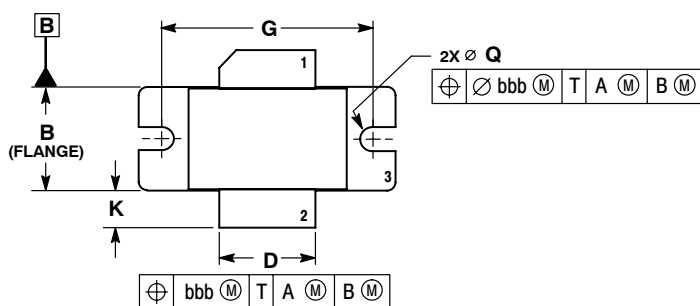

- NOTES:
1. DIMENSIONING AND TOLERANCING PER ANSI Y14.5M-1994.
 2. CONTROLLING DIMENSION: INCH.
 3. DIMENSION H IS MEASURED 0.030 (0.762) AWAY FROM PACKAGE BODY.
 4. DELETED

DIM	INCHES		MILLIMETERS	
	MIN	MAX	MIN	MAX
A	1.335	1.345	33.91	34.16
B	0.535	0.545	13.6	13.8
C	0.147	0.200	3.73	5.08
D	0.495	0.505	12.57	12.83
E	0.035	0.045	0.89	1.14
F	0.003	0.006	0.08	0.15
G	1.100 BSC		27.94 BSC	
H	0.057	0.067	1.45	1.70
K	0.170	0.210	4.32	5.33
M	0.872	0.888	22.15	22.55
N	0.871	0.889	19.30	22.60
Q	∅ .118	∅ .138	∅ 3.00	∅ 3.51
R	0.515	0.525	13.10	13.30
S	0.515	0.525	13.10	13.30
aaa	0.007 REF		0.178 REF	
bbb	0.010 REF		0.254 REF	
ccc	0.015 REF		0.381 REF	

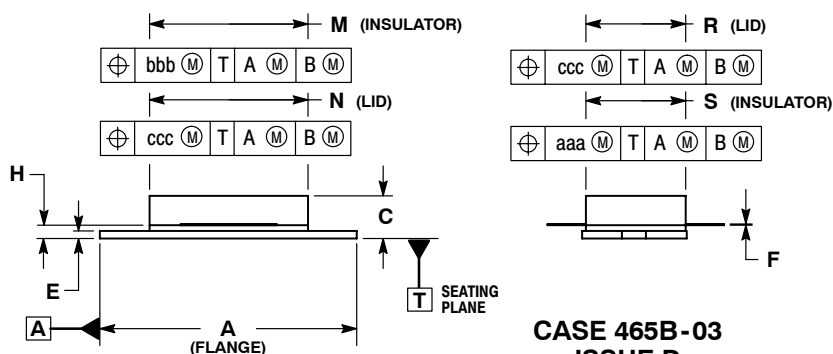

**CASE 465B-03
ISSUE D
NI-880
MRF7S21170HR3**

- STYLE 1:
PIN 1. DRAIN
2. GATE
3. SOURCE

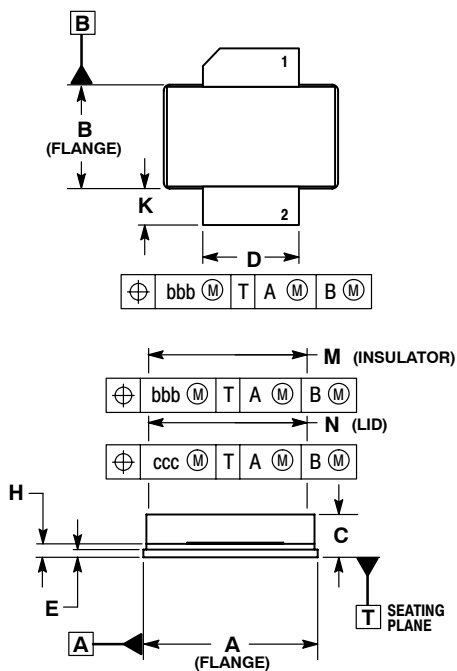

- NOTES:
1. DIMENSIONING AND TOLERANCING PER ANSI Y14.5M-1994.
 2. CONTROLLING DIMENSION: INCH.
 3. DIMENSION H IS MEASURED 0.030 (0.762) AWAY FROM PACKAGE BODY.

DIM	INCHES		MILLIMETERS	
	MIN	MAX	MIN	MAX
A	0.905	0.915	22.99	23.24
B	0.535	0.545	13.60	13.80
C	0.147	0.200	3.73	5.08
D	0.495	0.505	12.57	12.83
E	0.035	0.045	0.89	1.14
F	0.003	0.006	0.08	0.15
H	0.057	0.067	1.45	1.70
K	0.170	0.210	4.32	5.33
M	0.872	0.888	22.15	22.55
N	0.871	0.889	19.30	22.60
R	0.515	0.525	13.10	13.30
S	0.515	0.525	13.10	13.30
aaa	0.007 REF		0.178 REF	
bbb	0.010 REF		0.254 REF	
ccc	0.015 REF		0.381 REF	

- STYLE 1:
PIN 1. DRAIN
2. GATE
3. SOURCE

**CASE 465C-02
ISSUE D
NI-880S
MRF7S21170HSR3R3**

PRODUCT DOCUMENTATION

Refer to the following documents to aid your design process.

Application Notes

- AN1955: Thermal Measurement Methodology of RF Power Amplifiers

Engineering Bulletins

- EB212: Using Data Sheet Impedances for RF LDMOS Devices

REVISION HISTORY

The following table summarizes revisions to this document.

Date	Revision Number	Description
May 2006	0	<ul style="list-style-type: none">• Initial Release of Data Sheet
June 2006	1	<ul style="list-style-type: none">• Added Class C to description of parts, pg. 1• Changed "≥" to "-" in the Device Output Signal Par bullet, pg. 1• Changed typ value from ±9 to 18 in Part-to-Part Phase Variation characteristic description in Table 4, Typical Performances• Expanded the characterization range in the MTTF Factor graph from 200°C to 230°C, Fig. 12
Aug. 2006	2	<ul style="list-style-type: none">• Added Greater Negative Source bullet to Features section• Corrected Fig. 14, Single-Carrier W-CDMA Spectrum, to 3.84 MHz
Sept. 2006	3	<ul style="list-style-type: none">• Changed "Capable of Handling" bullet from 10:1 VSWR @ 28 Vdc to 5:1 VSWR @ 32 Vdc, pg. 1• Added "Insertion" to Part-to-Part Phase Variation characteristic description in Table 4, Typical Performances• Added Gain Flatness, Group Delay and Deviation from Linear Phase characteristics to Table 4, Typical Performances• Corrected Z6 value from "0.119" to "0.156", corrected Z8 value from "0.156" to "0.119", corrected Z9 value from "0.770" to "0.077", corrected Z11 value from "0.076" to "0.760", Fig. 1, Test Circuit Schematic• Added Part Number and Manufacturer for R1, R2 and R3 in Table 5, Test Circuit Component Designations and Values• Added Figure 10, Digital Predistortion Correction• Corrected Fig. 15, Single-Carrier W-CDMA Spectrum, to correctly reflect integrated bandwidth offsets• Added Figure 17, Pulsed CW Output Power versus Input Power @ 28 Vdc• Added Figure 18, Pulsed CW Output Power versus Input Power @ 32 Vdc

How to Reach Us:

Home Page:

www.freescale.com

E-mail:

support@freescale.com

USA/Europe or Locations Not Listed:

Freescale Semiconductor
Technical Information Center, CH370
1300 N. Alma School Road
Chandler, Arizona 85224
+1-800-521-6274 or +1-480-768-2130
support@freescale.com

Europe, Middle East, and Africa:

Freescale Halbleiter Deutschland GmbH
Technical Information Center
Schatzbogen 7
81829 Muenchen, Germany
+44 1296 380 456 (English)
+46 8 52200080 (English)
+49 89 92103 559 (German)
+33 1 69 35 48 48 (French)
support@freescale.com

Japan:

Freescale Semiconductor Japan Ltd.
Headquarters
ARCO Tower 15F
1-8-1, Shimo-Meguro, Meguro-ku,
Tokyo 153-0064
Japan
0120 191014 or +81 3 5437 9125
support.japan@freescale.com

Asia/Pacific:

Freescale Semiconductor Hong Kong Ltd.
Technical Information Center
2 Dai King Street
Tai Po Industrial Estate
Tai Po, N.T., Hong Kong
+800 2666 8080
support.asia@freescale.com

For Literature Requests Only:

Freescale Semiconductor Literature Distribution Center
P.O. Box 5405
Denver, Colorado 80217
1-800-441-2447 or 303-675-2140
Fax: 303-675-2150
LDCForFreescaleSemiconductor@hibbertgroup.com

Information in this document is provided solely to enable system and software implementers to use Freescale Semiconductor products. There are no express or implied copyright licenses granted hereunder to design or fabricate any integrated circuits or integrated circuits based on the information in this document.

Freescale Semiconductor reserves the right to make changes without further notice to any products herein. Freescale Semiconductor makes no warranty, representation or guarantee regarding the suitability of its products for any particular purpose, nor does Freescale Semiconductor assume any liability arising out of the application or use of any product or circuit, and specifically disclaims any and all liability, including without limitation consequential or incidental damages. "Typical" parameters that may be provided in Freescale Semiconductor data sheets and/or specifications can and do vary in different applications and actual performance may vary over time. All operating parameters, including "Typicals", must be validated for each customer application by customer's technical experts. Freescale Semiconductor does not convey any license under its patent rights nor the rights of others. Freescale Semiconductor products are not designed, intended, or authorized for use as components in systems intended for surgical implant into the body, or other applications intended to support or sustain life, or for any other application in which the failure of the Freescale Semiconductor product could create a situation where personal injury or death may occur. Should Buyer purchase or use Freescale Semiconductor products for any such unintended or unauthorized application, Buyer shall indemnify and hold Freescale Semiconductor and its officers, employees, subsidiaries, affiliates, and distributors harmless against all claims, costs, damages, and expenses, and reasonable attorney fees arising out of, directly or indirectly, any claim of personal injury or death associated with such unintended or unauthorized use, even if such claim alleges that Freescale Semiconductor was negligent regarding the design or manufacture of the part.

Freescale™ and the Freescale logo are trademarks of Freescale Semiconductor, Inc. All other product or service names are the property of their respective owners.
© Freescale Semiconductor, Inc. 2006. All rights reserved.

