

74LCXH16245

Low Voltage 16-Bit Bidirectional Transceiver with Bushold

General Description

The LCXH16245 contains sixteen non-inverting bidirectional buffers with 3-STATE outputs and is intended for bus oriented applications. The device is designed for low voltage (2.5V or 3.3V) V_{CC} applications with capability of interfacing to a 5V signal environment. The device is byte controlled. Each byte has separate control inputs which could be shorted together for full 16-bit operation. The T/R inputs determine the direction of data flow through the device. The OE inputs disable both the A and B Ports by placing them in a high impedance state.

The LCXH16245 data inputs include active bushold circuitry, eliminating the need for external pull-up resistors to hold unused or floating data inputs at a valid logic level.

The LCXH16245 is fabricated with an advanced CMOS technology to achieve high speed operation while maintaining CMOS low power dissipation.

Features

- 2.3V–3.6V V_{CC} specifications provided
- 4.5 ns t_{PD} max ($V_{CC} = 3.3V$), 20 μA I_{CC} max
- Power-down high impedance outputs
- Bushold on inputs eliminates the need for external pull-up/pull-down resistors
- ± 24 mA output drive ($V_{CC} = 3.0V$)
- Implements patented noise/EMI reduction circuitry
- Latch-up performance conforms to the requirements of JESD78
- ESD performance:
 - Human body model > 2000V
 - Machine model > 200V
- Also packaged in plastic Fine-Pitch Ball Grid Array (FBGA)

Ordering Code:

Order Number	Package Number	Package Description
74LCXH16245G (Note 1) (Note 2)	BGA54A	54-Ball Fine-Pitch Ball Grid Array (FBGA), JEDEC MO-205, 5.5mm Wide
74LCXH16245MTD (Note 2)	MTD48	48-Lead Thin Shrink Small Outline Package (TSSOP), JEDEC MO-153, 6.1mm Wide

Note 1: Ordering Code "G" indicates Trays.

Note 2: Devices also available in Tape and Reel. Specify by appending the suffix letter "X" to the ordering code.

Logic Symbol

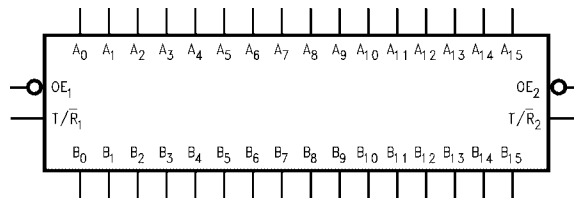

Connection Diagrams

Pin Assignment for SSOP and TSSOP

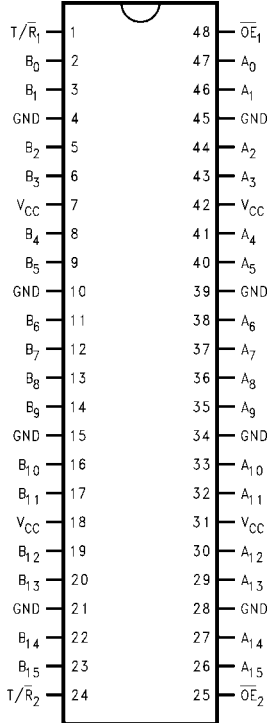

Pin Assignment for FBGA

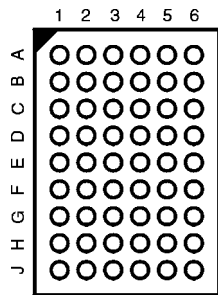

(Top Thru View)

Pin Descriptions

Pin Names	Description
\overline{OE}_n	Output Enable Input
T/\overline{R}_n	Transmit/Receive Input
A_0-A_{15}	Side A Inputs or 3-STATE Outputs (Bushold)
B_0-B_{15}	Side B Inputs or 3-STATE Outputs (Bushold)

FBGA Pin Assignments

	1	2	3	4	5	6
A	B_0	NC	T/\overline{R}_1	\overline{OE}_1	NC	A_0
B	B_2	B_1	NC	NC	A_1	A_2
C	B_4	B_3	V_{CC}	V_{CC}	A_3	A_4
D	B_6	B_5	GND	GND	A_5	A_6
E	B_8	B_7	GND	GND	A_7	A_8
F	B_{10}	B_9	GND	GND	A_9	A_{10}
G	B_{12}	B_{11}	V_{CC}	V_{CC}	A_{11}	A_{12}
H	B_{14}	B_{13}	NC	NC	A_{13}	A_{14}
J	B_{15}	NC	T/\overline{R}_2	\overline{OE}_2	NC	A_{15}

Truth Tables

Inputs		Outputs
\overline{OE}_1	T/\overline{R}_1	
L	L	Bus B_0-B_7 Data to Bus A_0-A_7
L	H	Bus A_0-A_7 Data to Bus B_0-B_7
H	X	HIGH Z State on A_0-A_7, B_0-B_7

Inputs		Outputs
\overline{OE}_2	T/\overline{R}_2	
L	L	Bus B_8-B_{15} Data to Bus A_8-A_{15}
L	H	Bus A_8-A_{15} Data to Bus B_8-B_{15}
H	X	HIGH Z State on A_8-A_{15}, B_8-B_{15}

H = HIGH Voltage Level
 L = LOW Voltage Level
 X = Immaterial
 Z = High Impedance

Logic Diagram

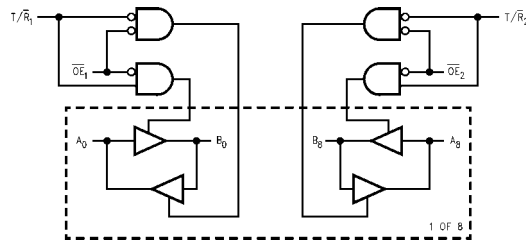

Absolute Maximum Ratings ^(Note 3)						
Symbol	Parameter	Value	Conditions	Units		
V _{CC}	Supply Voltage	-0.5 to +7.0		V		
V _I	DC Input Voltage	-0.5 to V _{CC} + 0.5		V		
V _O	DC Output Voltage	-0.5 to +7.0 -0.5 to V _{CC} + 0.5	Output in 3-STATE Output in HIGH or LOW State (Note 4)	V		
I _{IK}	DC Input Diode Current	-50	V _I < GND	mA		
I _{OK}	DC Output Diode Current	-50 +50	V _O < GND V _O > V _{CC}	mA		
I _O	DC Output Source/Sink Current	±50		mA		
I _{CC}	DC Supply Current per Supply Pin	±100		mA		
I _{GND}	DC Ground Current per Ground Pin	±100		mA		
T _{STG}	Storage Temperature	-65 to +150		°C		
Recommended Operating Conditions (Note 5)						
Symbol	Parameter	Min	Max	Units		
V _{CC}	Supply Voltage	Operating	2.0	3.6	V	
		Data Retention	1.5	3.6		
V _I	Input Voltage	0	V _{CC}	V		
V _O	Output Voltage	HIGH or LOW State	0	V _{CC}	V	
		3-STATE	0	V _{CC}		
I _{OH} /I _{OL}	Output Current	V _{CC} = 3.0V – 3.6V		±24	mA	
		V _{CC} = 2.7V – 3.0V		±12		
		V _{CC} = 2.3V – 2.7V		±8		
T _A	Free-Air Operating Temperature	-40	85	°C		
Δt/ΔV	Input Edge Rate, V _{IN} = 0.8V–2.0V, V _{CC} = 3.0V	0	10	ns/V		
<p>Note 3: The Absolute Maximum Ratings are those values beyond which the safety of the device cannot be guaranteed. The device should not be operated at these limits. The parametric values defined in the Electrical Characteristics tables are not guaranteed at the Absolute Maximum Ratings. The "Recommended Operating Conditions" table will define the conditions for actual device operation.</p> <p>Note 4: I_O Absolute Maximum Rating must be observed.</p> <p>Note 5: Floating or unused control inputs must be HIGH or LOW.</p>						
DC Electrical Characteristics						
Symbol	Parameter	Conditions	V _{CC} (V)	T _A = -40°C to +85°C		Units
				Min	Max	
V _{IH}	HIGH Level Input Voltage		2.3 – 2.7	1.7		V
			2.7 – 3.6	2.0		
V _{IL}	LOW Level Input Voltage		2.3 – 2.7		0.7	V
			2.7 – 3.6		0.8	
V _{OH}	HIGH Level Output Voltage	I _{OH} = -100 μA	2.3 – 3.6	V _{CC} - 0.2		V
		I _{OH} = -8 mA	2.3	1.8		
		I _{OH} = -12 mA	2.7	2.2		
		I _{OH} = -18 mA	3.0	2.4		
		I _{OH} = -24 mA	3.0	2.2		
V _{OL}	LOW Level Output Voltage	I _{OL} = 100 μA	2.3 – 3.6		0.2	V
		I _{OL} = 8 mA	2.3		0.6	
		I _{OL} = 12 mA	2.7		0.4	
		I _{OL} = 16 mA	3.0		0.4	
		I _{OL} = 24 mA	3.0		0.55	
I _I	Input Leakage Current	Data	V _I = V _{CC} or GND	2.3 – 3.6	±5.0	μA
		Control	0 ≤ V _I ≤ 5.5	2.3 – 3.6	±5.0	

DC Electrical Characteristics (Continued)

Symbol	Parameter	Conditions	V _{CC} (V)	T _A = -40°C to +85°C		Units
				Min	Max	
I _{I(HOLD)}	Bushold Input Minimum Drive Hold Current	V _{IN} = 0.7V	2.3	45		μA
		V _{IN} = 1.7V		-45		
		V _{IN} = 0.8V	3.0	75		
		V _{IN} = 2.0V		-75		
I _{I(OD)}	Bushold Input Over-Drive Current to Change State	(Note 6)	2.7	300		μA
		(Note 7)		-300		
		(Note 6)	3.6	450		
		(Note 7)		-450		
I _{OZ}	3-STATE I/O Leakage	V _O = V _{CC} or GND	2.3 – 3.6		±5.0	μA
I _{OFF}	Power-Off Leakage Current	V _I or V _O = 5.5V	0		10	μA
I _{CC}	Quiescent Supply Current	V _I = V _{CC} or GND	2.3–3.6		20	μA
ΔI _{CC}	Increase in I _{CC} per Input	V _{IH} = V _{CC} - 0.6V	2.3–3.6		500	μA

Note 6: An external driver must source at least the specified current to switch from LOW-to-HIGH.

Note 7: An external driver must sink at least the specified current to switch from HIGH-to-LOW.

AC Electrical Characteristics

Symbol	Parameter	T _A = -40°C to +85°C, R _L = 500Ω						Units
		V _{CC} = 3.3V ± 0.3V		V _{CC} = 2.7V		V _{CC} = 2.5V ± 0.2V		
		C _L = 50 pF		C _L = 50 pF		C _L = 30 pF		
		Min	Max	Min	Max	Min	Max	
t _{PHL}	Propagation Delay	1.0	4.5	1.0	5.2	1.0	5.4	ns
t _{PLH}	A _n to B _n or B _n to A _n	1.0	4.5	1.0	5.2	1.0	5.4	
t _{PZL}	Output Enable Time	1.0	6.5	1.0	7.2	1.0	8.5	ns
t _{PZH}	Output Disable Time	1.0	6.5	1.0	7.2	1.0	8.5	
t _{PLZ}	Output Disable Time	1.0	6.4	1.0	6.9	1.0	7.7	ns
t _{PHZ}	Output Enable Time	1.0	6.4	1.0	6.9	1.0	7.7	
t _{OSSL}	Output to Output Skew (Note 8)		1.0					ns
t _{OSLH}			1.0					

Note 8: Skew is defined as the absolute value of the difference between the actual propagation delay for any two separate outputs of the same device. The specification applies to any outputs switching in the same direction, either HIGH-to-LOW (t_{OSSL}) or LOW-to-HIGH (t_{OSLH}). Parameter guaranteed by design.

Dynamic Switching Characteristics

Symbol	Parameter	Conditions	V _{CC} (V)	T _A = 25°C	Units
				Typical	
V _{OLP}	Quiet Output Dynamic Peak V _{OL}	C _L = 50 pF, V _{IH} = 3.3V, V _{IL} = 0V	3.3	0.8	V
		C _L = 30 pF, V _{IH} = 2.5V, V _{IL} = 0V	2.5	0.6	
V _{OLV}	Quiet Output Dynamic Valley V _{OL}	C _L = 50 pF, V _{IH} = 3.3V, V _{IL} = 0V	3.3	-0.8	V
		C _L = 30 pF, V _{IH} = 2.5V, V _{IL} = 0V	2.5	-0.6	

Capacitance

Symbol	Parameter	Conditions	Typical	Units
C _{IN}	Input Capacitance	V _{CC} = Open, V _I = 0V or V _{CC}	7	pF
C _{I/O}	Input/Output Capacitance	V _{CC} = 3.3V, V _I = 0V or V _{CC}	8	pF
C _{PD}	Power Dissipation Capacitance	V _{CC} = 3.3V, V _I = 0V or V _{CC} , f = 10 MHz	20	pF

AC LOADING and WAVEFORMS Generic for LCX Family

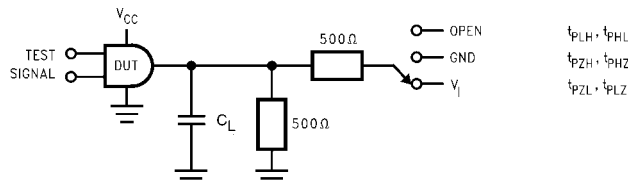
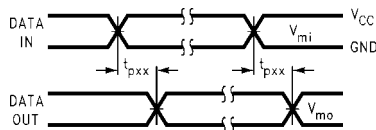
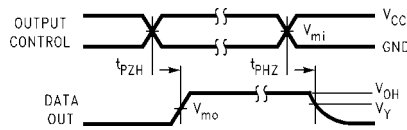

FIGURE 1. AC Test Circuit (C_L includes probe and jig capacitance)

Test	Switch
t_{PLH} , t_{PHL}	Open
t_{PZL} , t_{PLZ}	6V at $V_{CC} = 3.3 \pm 0.3V$, 2.7V and $V_{CC} \times 2$ at $V_{CC} = 2.5 \pm 0.2V$
t_{PZH} , t_{PHZ}	GND



Waveform for Inverting and Non-Inverting Functions



3-STATE Output High Enable and Disable Times for Logic

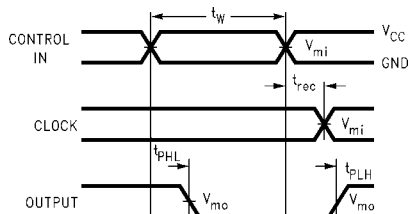

Propagation Delay, Pulse Width and t_{rec} Waveforms

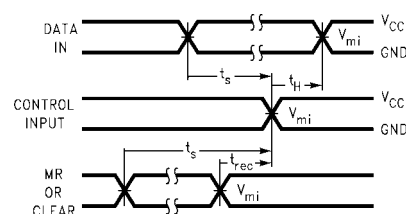

Setup Time, Hold Time and Recovery Time for Logic

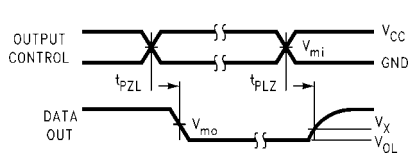

3-STATE Output Low Enable and Disable Times for Logic

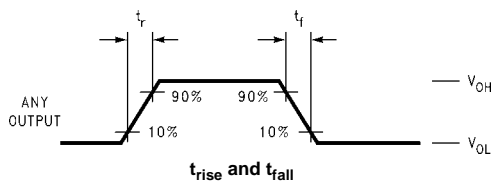
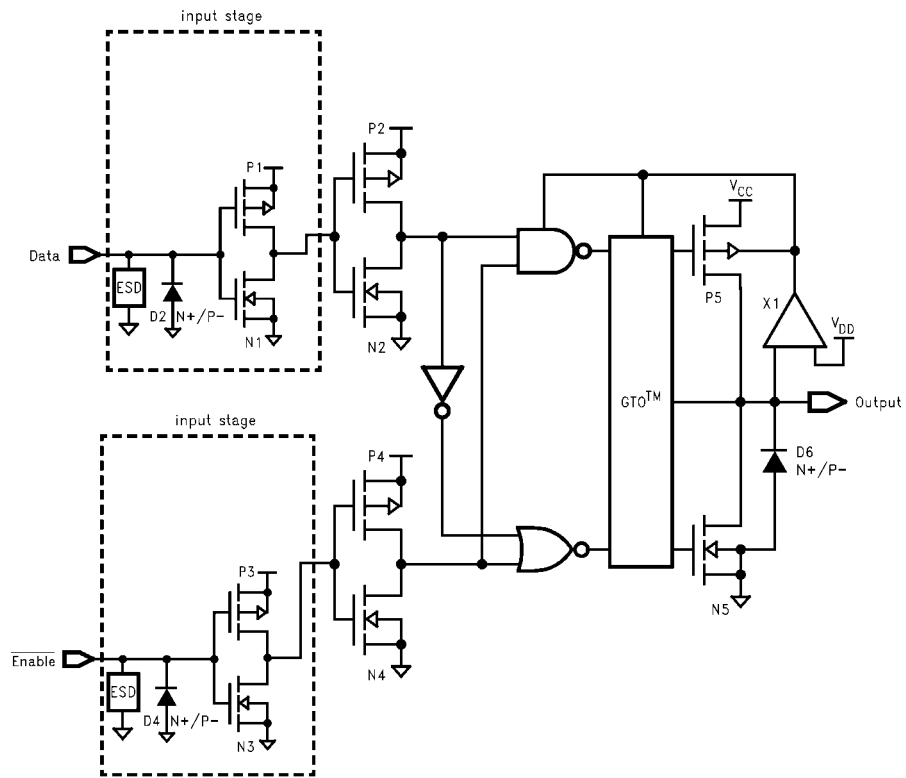

FIGURE 2. Waveforms
(Input Characteristics; $f = 1MHz$, $t_r = t_f = 3ns$)

Symbol	V_{CC}		
	$3.3V \pm 0.3V$	2.7V	$2.5V \pm 0.2V$
V_{mi}	1.5V	1.5V	$V_{CC}/2$
V_{mo}	1.5V	1.5V	$V_{CC}/2$
V_x	$V_{OL} + 0.3V$	$V_{OL} + 0.3V$	$V_{OL} + 0.15V$
V_y	$V_{OH} - 0.3V$	$V_{OH} - 0.3V$	$V_{OH} - 0.15V$

Schematic Diagram Generic for LCX Family



Physical Dimensions inches (millimeters) unless otherwise noted

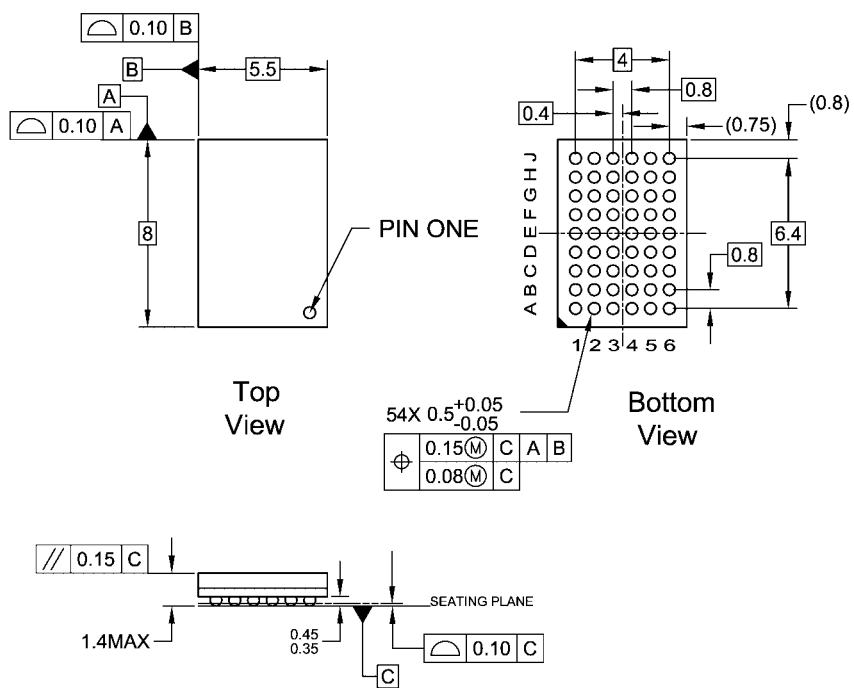

NOTES:

- A. THIS PACKAGE CONFORMS TO JEDEC M0-205
- B. ALL DIMENSIONS IN MILLIMETERS
- C. LAND PATTERN RECOMMENDATION: NSMD (Non Solder Mask Defined)
.35MM DIA PADS WITH A SOLDERMASK OPENING OF .45MM CONCENTRIC TO PADS
- D. DRAWING CONFORMS TO ASME Y14.5M-1994

BGA54ArevD

**54-Ball Fine-Pitch Ball Grid Array (FBGA), JEDEC M0-205, 5.5mm Wide
Package Number BGA54A**

Physical Dimensions inches (millimeters) unless otherwise noted (Continued)

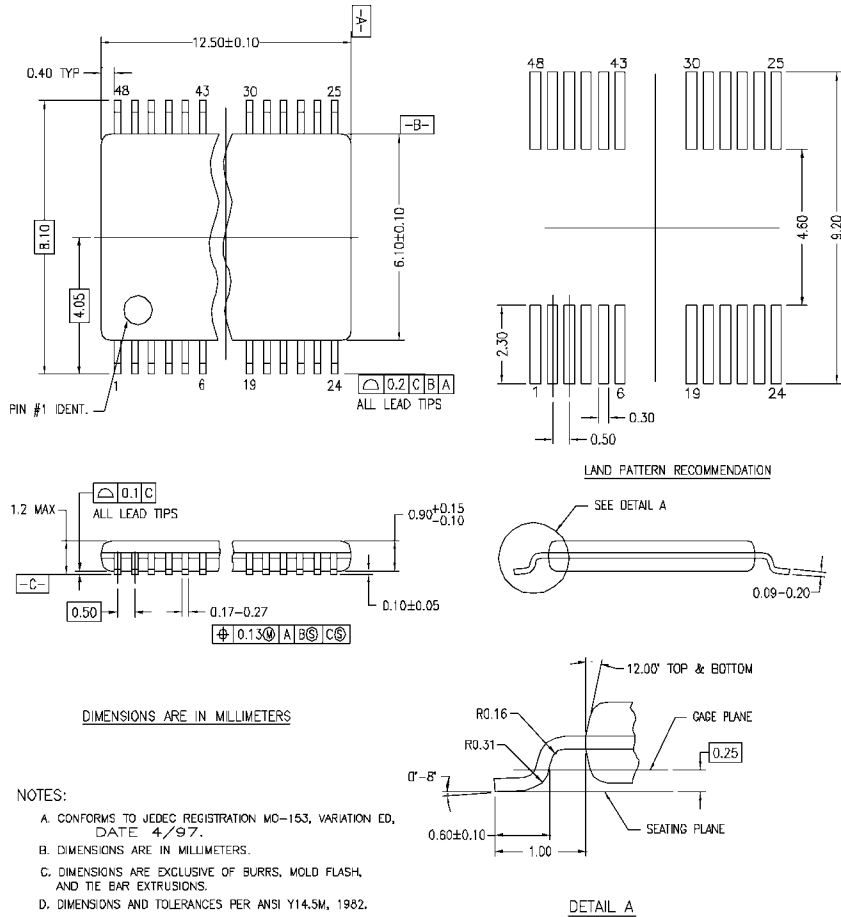

MTD48REV C

**48-Lead Thin Shrink Small Outline Package (TSSOP), JEDEC MO-153, 6.1mm Wide
Package Number MTD48**

Fairchild does not assume any responsibility for use of any circuitry described, no circuit patent licenses are implied and Fairchild reserves the right at any time without notice to change said circuitry and specifications.

LIFE SUPPORT POLICY

FAIRCHILD'S PRODUCTS ARE NOT AUTHORIZED FOR USE AS CRITICAL COMPONENTS IN LIFE SUPPORT DEVICES OR SYSTEMS WITHOUT THE EXPRESS WRITTEN APPROVAL OF THE PRESIDENT OF FAIRCHILD SEMICONDUCTOR CORPORATION. As used herein:

- Life support devices or systems are devices or systems which, (a) are intended for surgical implant into the body, or (b) support or sustain life, and (c) whose failure to perform when properly used in accordance with instructions for use provided in the labeling, can be reasonably expected to result in a significant injury to the user.
- A critical component in any component of a life support device or system whose failure to perform can be reasonably expected to cause the failure of the life support device or system, or to affect its safety or effectiveness.

www.fairchildsemi.com