

SPNovaLED[™]

Featuring a staggering brilliance and significant flux output, the SPNovaLED[™] showcases the latest technological advent in this range. With its extremely high level of brightness and the ultra low high profile, which is only 1.5 mm are highly suitable for both conventional lighting and specialized application such as automotive signal lights, traffic lights, channel lights, tube lights and garden lights among others.



Features:

- > Super high brightness surface mount LED.
- > High flux output.
- > 130° viewing angle.
- > Compact package outline (LxW) of 6.0 x 6.0 mm.
- > Ultra low height profile - 1.5 mm.
- > Qualified according to JEDEC moisture sensitivity Level 2.
- > Compatible to IR reflow soldering.
- > Environmental friendly; RoHS compliance.

Applications:

- > Lighting: backlighting, garden light, architecture lighting, general lighting. etc

Optical Characteristics at Ta=25°C, If = 20mA

Part Number	IV Bin	Intensity @ If=20mA (mcd)		Viewing Angle°
		Min.	Max.	
NMRTB-CSS-T3U3+U3V3+R3S3-1				130
• Red	T3	320.0	450.0	
	U3	450.0	637.5	
• True Green	U3	715.0	1012.0	
	V3	1012.0	1400.0	
• Blue	R3	140.0	202.0	
	S3	202.0	285.0	

Radiant intensity is measured with an accuracy of ± 11%.

Wavelength Grouping at Ta=25°C

Color	Group	Wavelength distribution (nm)
Red	Full	619 - 630
True Green	A	520 - 525
	B	525 - 530
	C	530 - 535
Blue	A	460 - 465
	B	465 - 470

Dominant wavelength is measured with an accuracy of ± 1 nm.

Electrical Characteristics at Ta=25°C

Part Number	Vf @ If = 20mA		
	Min. (V)	Typ. (V)	Max. (V)
NMRTB-CSS			
• Red	1.9	2.0	2.5
• True Green	3.0	3.2	3.6
• Blue	3.0	3.2	3.6

Forward voltages are measure using a current pulse of 1 ms and with an accuracy of ± 0.1V.

Correlation Between Luminous Intensity And Luminous Flux

Color	IV Bins	Luminous Intensity (mcd)		Luminous Flux (lm)	
		Min.	Max.	Min.	Max.
Red	T3	320.0	450.0	0.90	1.26
	U3	450.0	637.5	1.26	1.79
True Green	U3	715.0	1012.0	1.93	2.73
	V3	1012.0	1400.0	2.73	3.78
Blue	R3	140.0	202.0	0.35	0.51
	S3	202.0	285.0	0.51	0.71

Note: Data provided above is based on approximation

Material

Material	
Lead-frame	Cu Alloy With Ag Plating
Package	High Temperature Resistant Plastic, PPA
Encapsulate	Silicone Resin
Soldering Leads	Sn-Sn Plating

Note: Product has no lead (Pb) content.

Absolute Maximum Ratings

	Maximum Value	Unit
DC forward current (per chip)	Red 50 True Green, Blue 30	mA
Peak pulse current (per chip)	Red 200 True Green, Blue 100	mA
Reverse Voltage	Not designed for reverse bias	V
ESD Threshold (HBM)	2	kV
LED junction temperature	125	°C
Operating temperature	-40 ... +100	°C
Storage temperature	-40 ... +100	°C

Forward Current Vs Forward Voltage (Red)

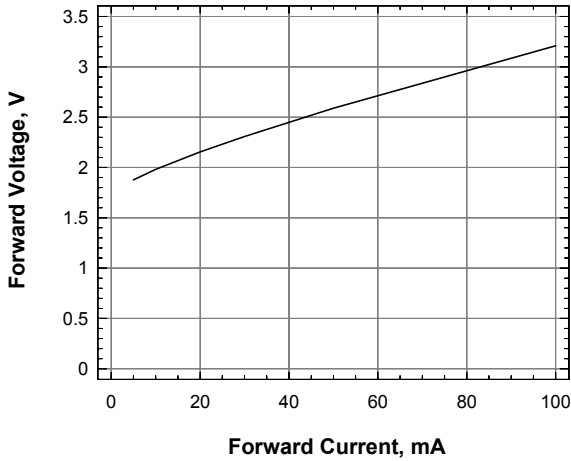

Forward Current Vs Forward Voltage (Blue and True Green)

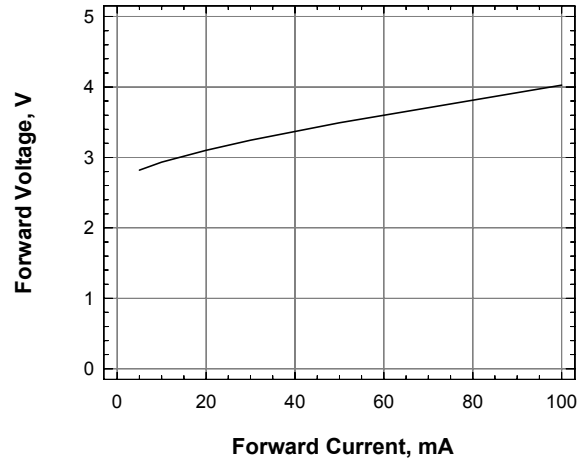

Wavelength Shift Vs Forward Current (Blue)

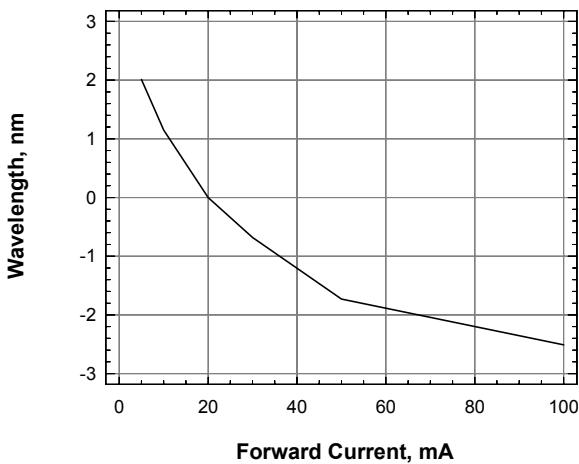

Wavelength Shift Vs Forward Current (True Green)

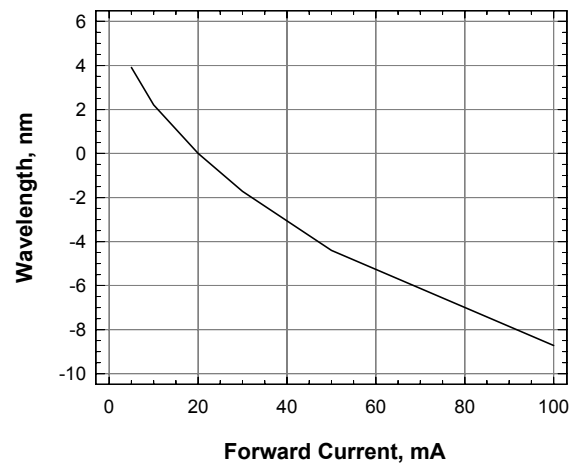

Max Pulse Current Vs Duty Cycle (Red)

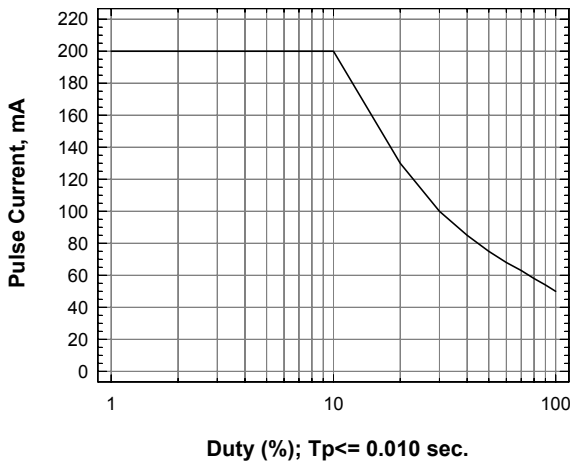

Max Pulse Current Vs Duty Cycle (True Green, Blue)

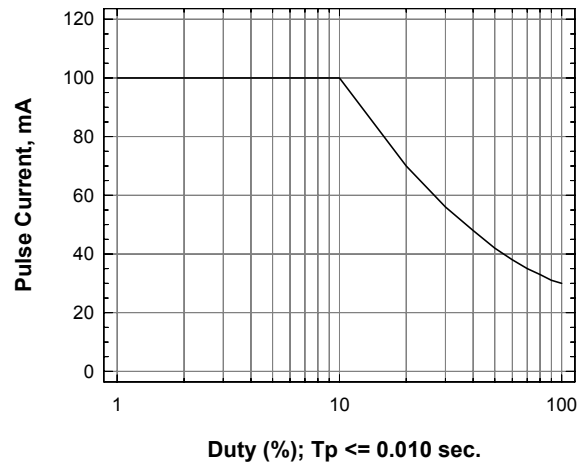

Max Current Vs Ambient Temperature

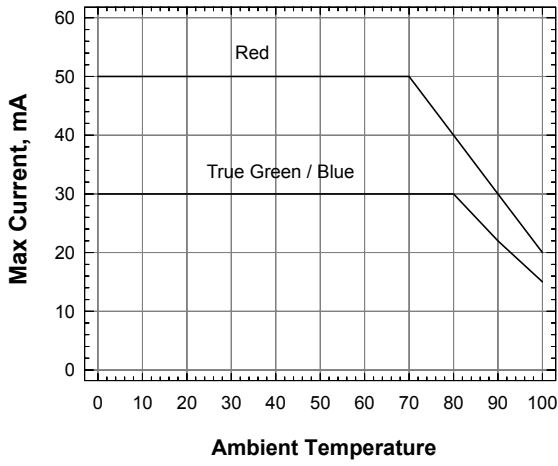

Radiation Pattern

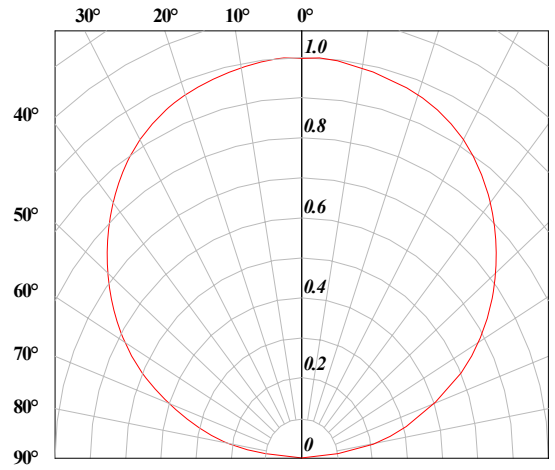

SPNovaLED™ • RGB : 20mA Package Outlines

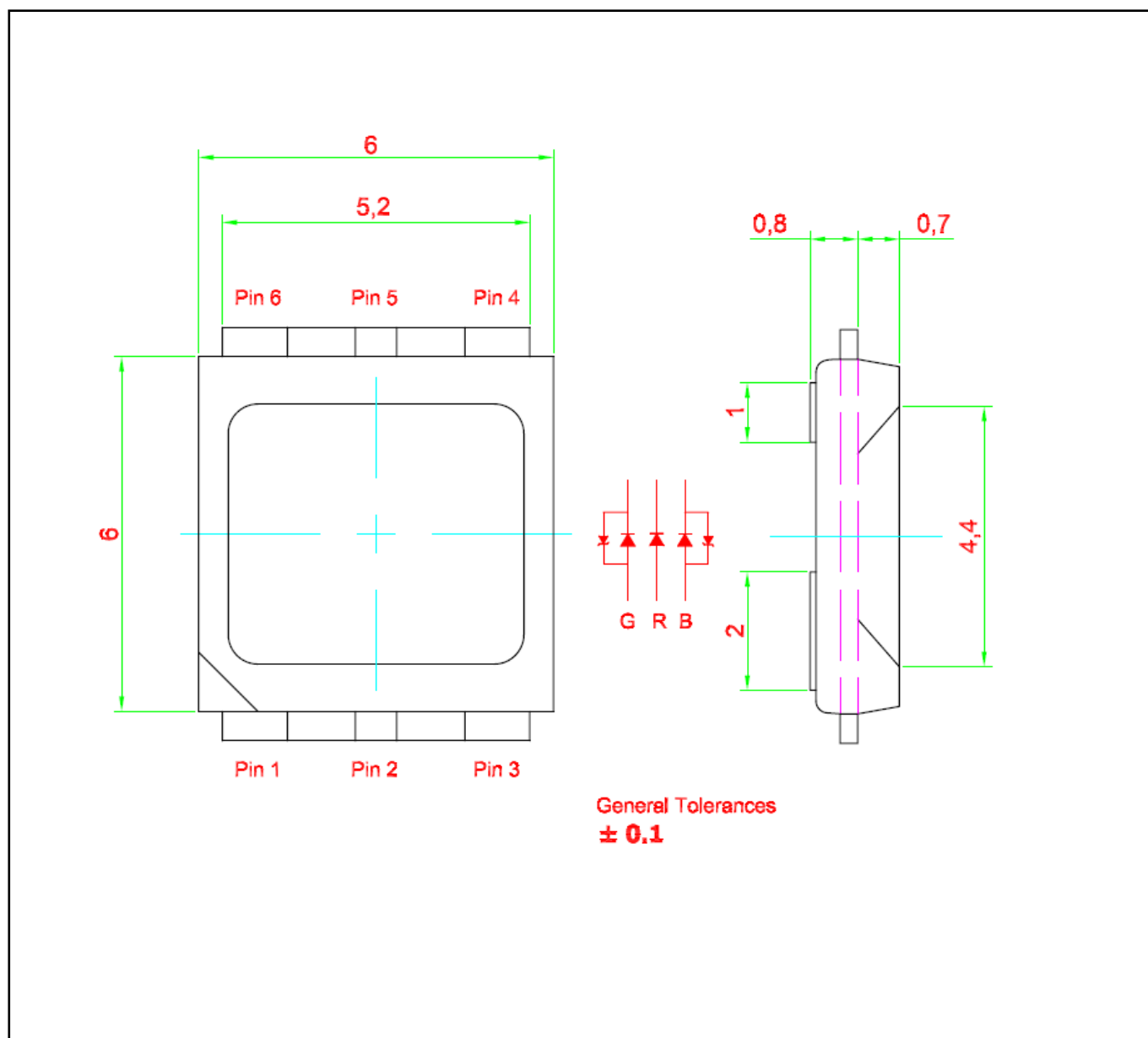

Solder Pad Design

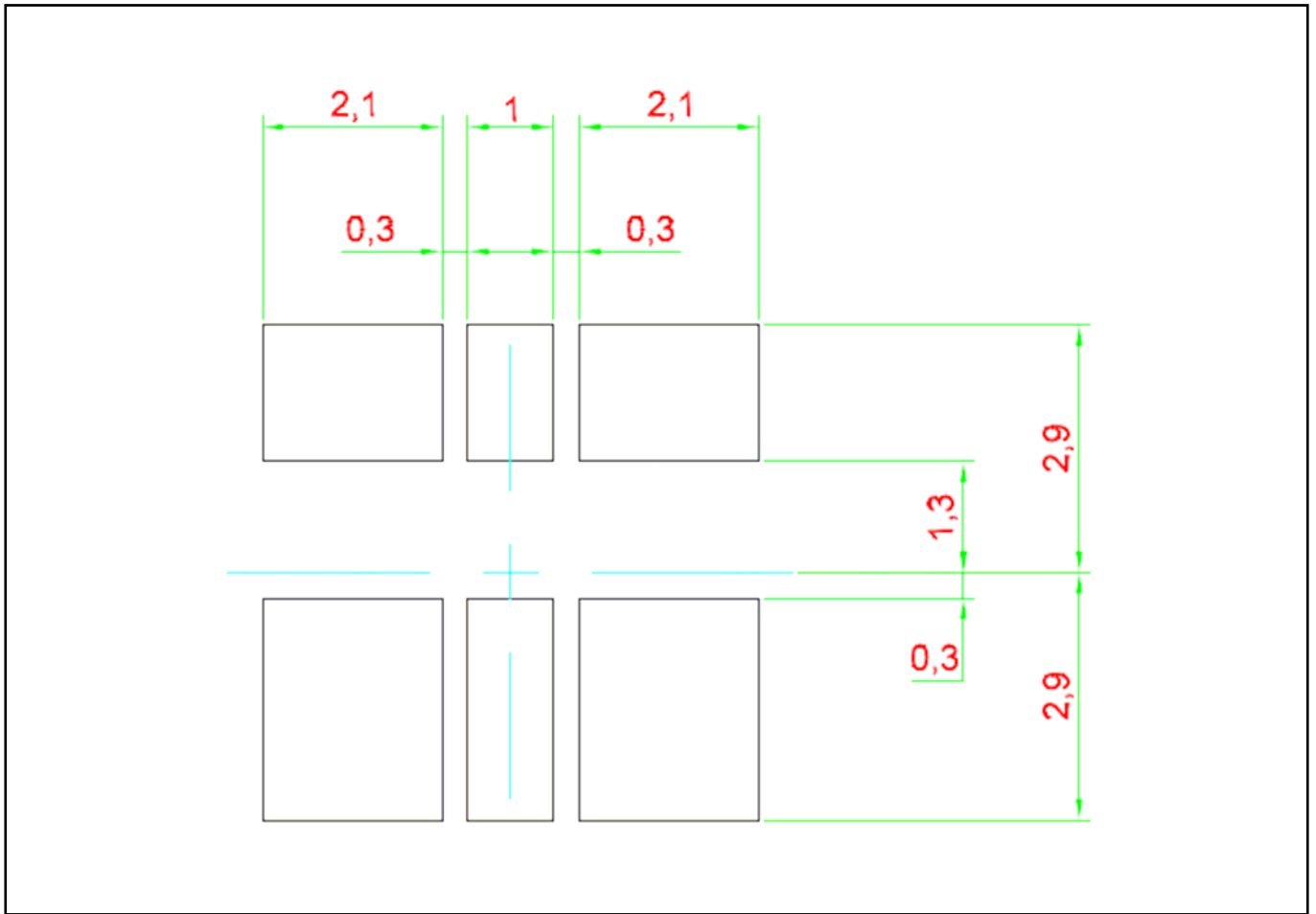

Taping and orientation

- Reels come in quantity of 1000 units.
- Reel diameter is 330 mm.

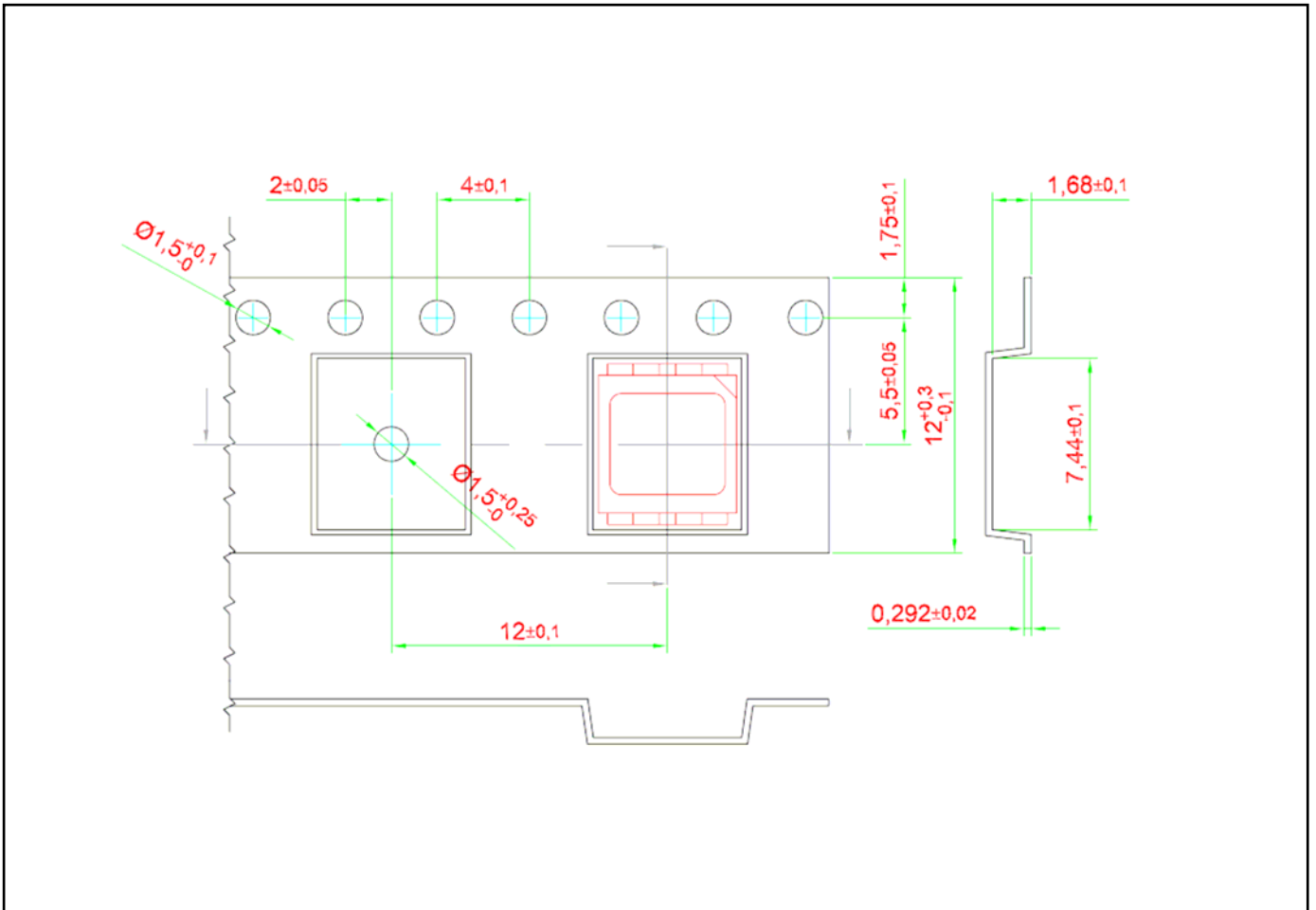

Packaging Specification

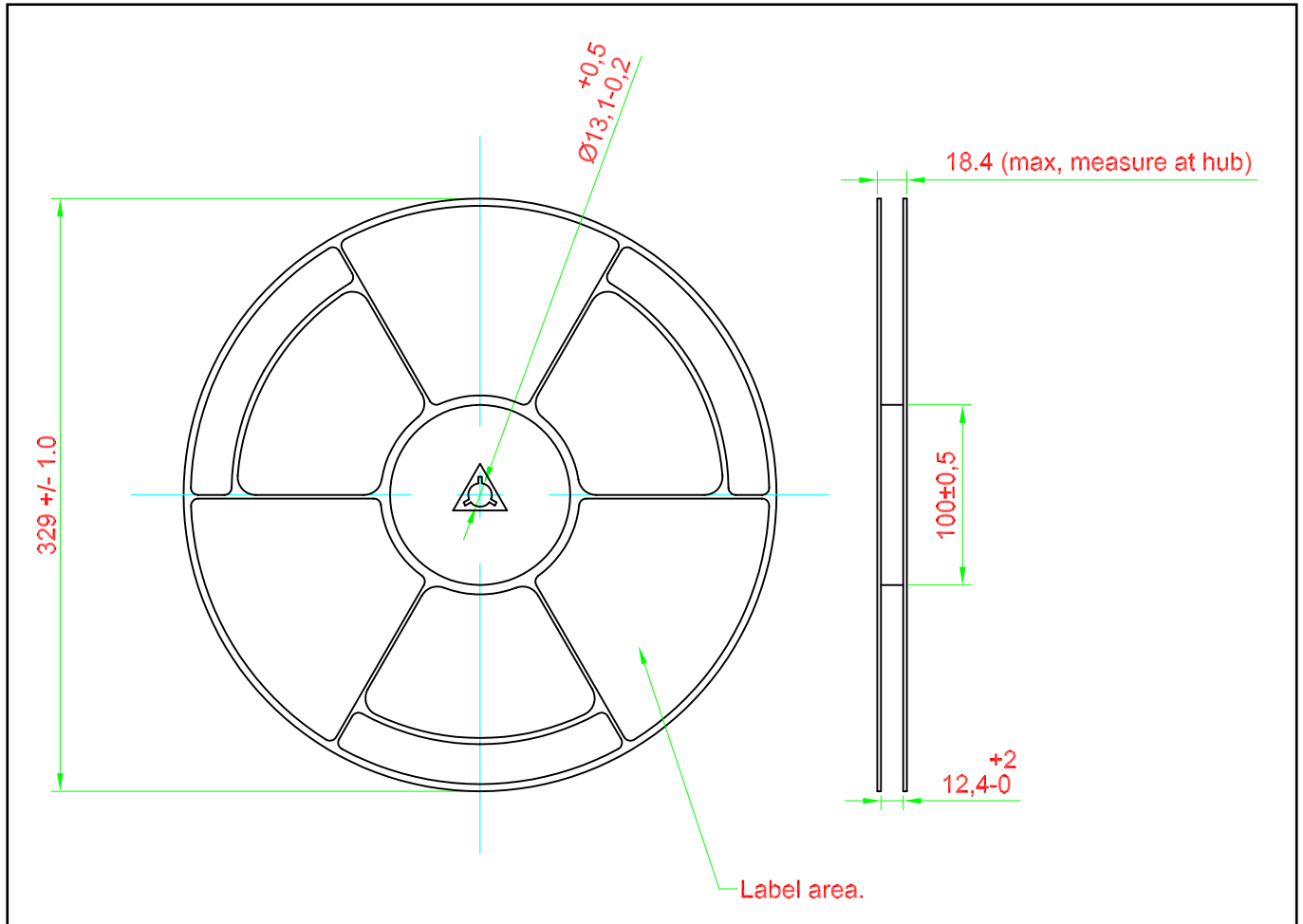

Packaging Specification

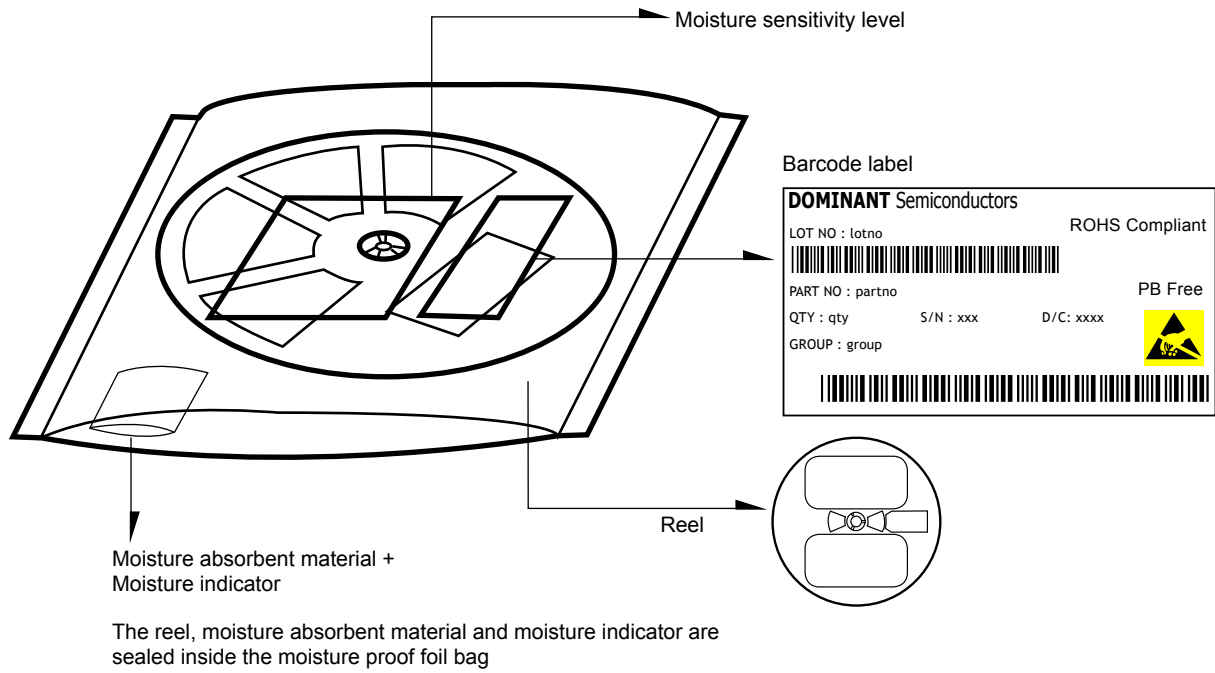

	Average 1pc SPNovaLED	1 completed bag (1000pcs)
Weight (gram)	0.188	600 ± 10

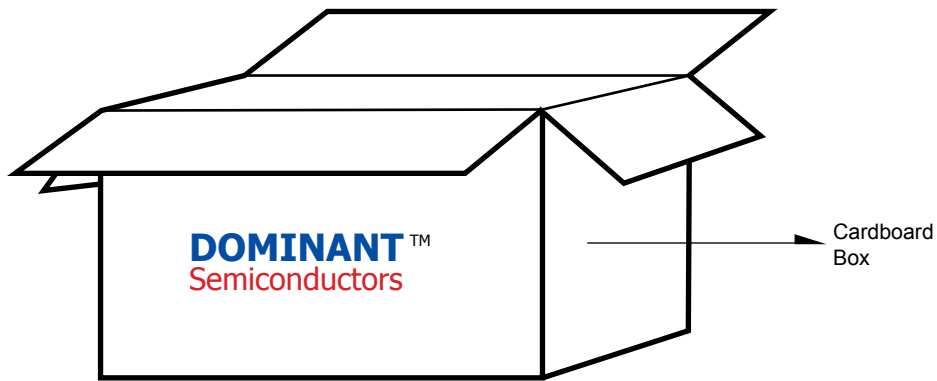

For SPNovaLED™

Cardboard Box Size	Dimensions (mm)	Empty Box Weight (kg)	Reel / Box	Quantity / Box (pcs)
Large	416 x 516 x 476	1.74	20 reels MAX	20,000 MAX

Recommended Sn-Pb IR-Reflow Soldering Profile

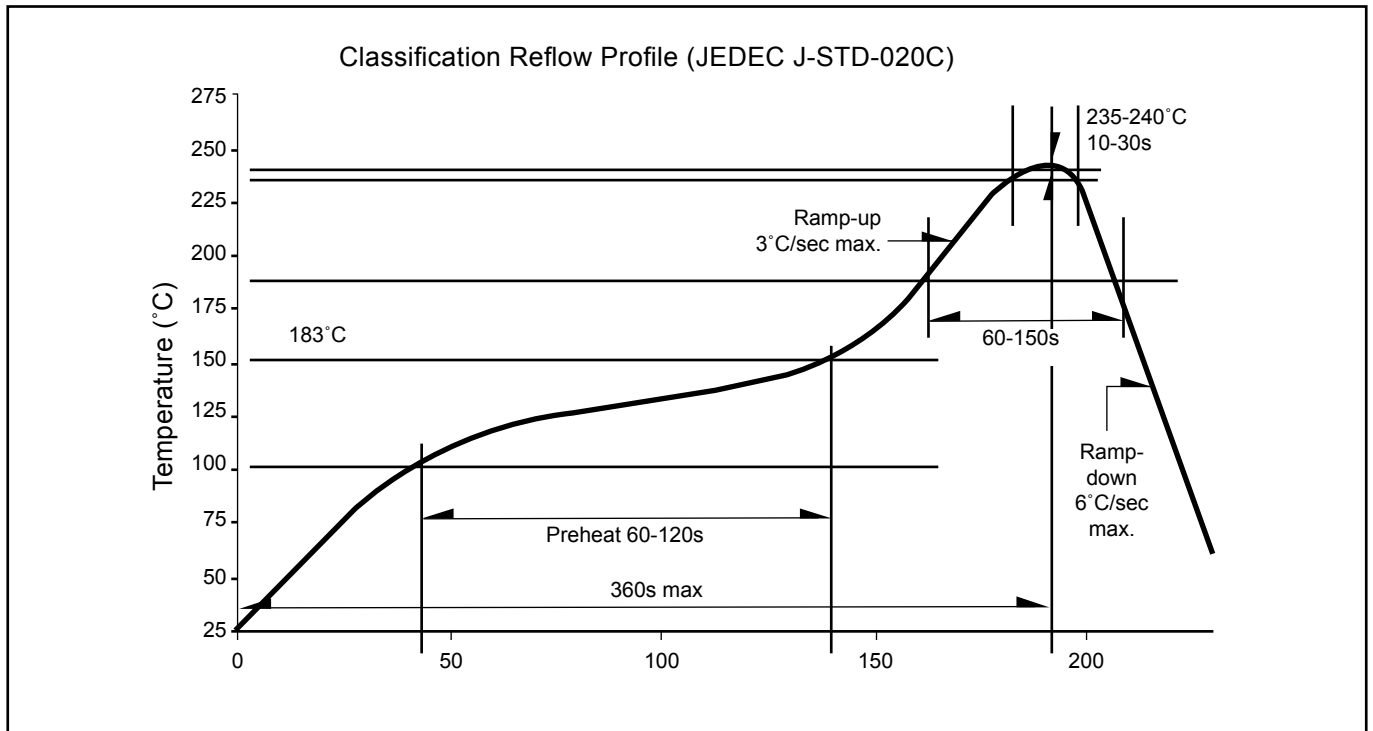

Recommended Pb-free Soldering Profile

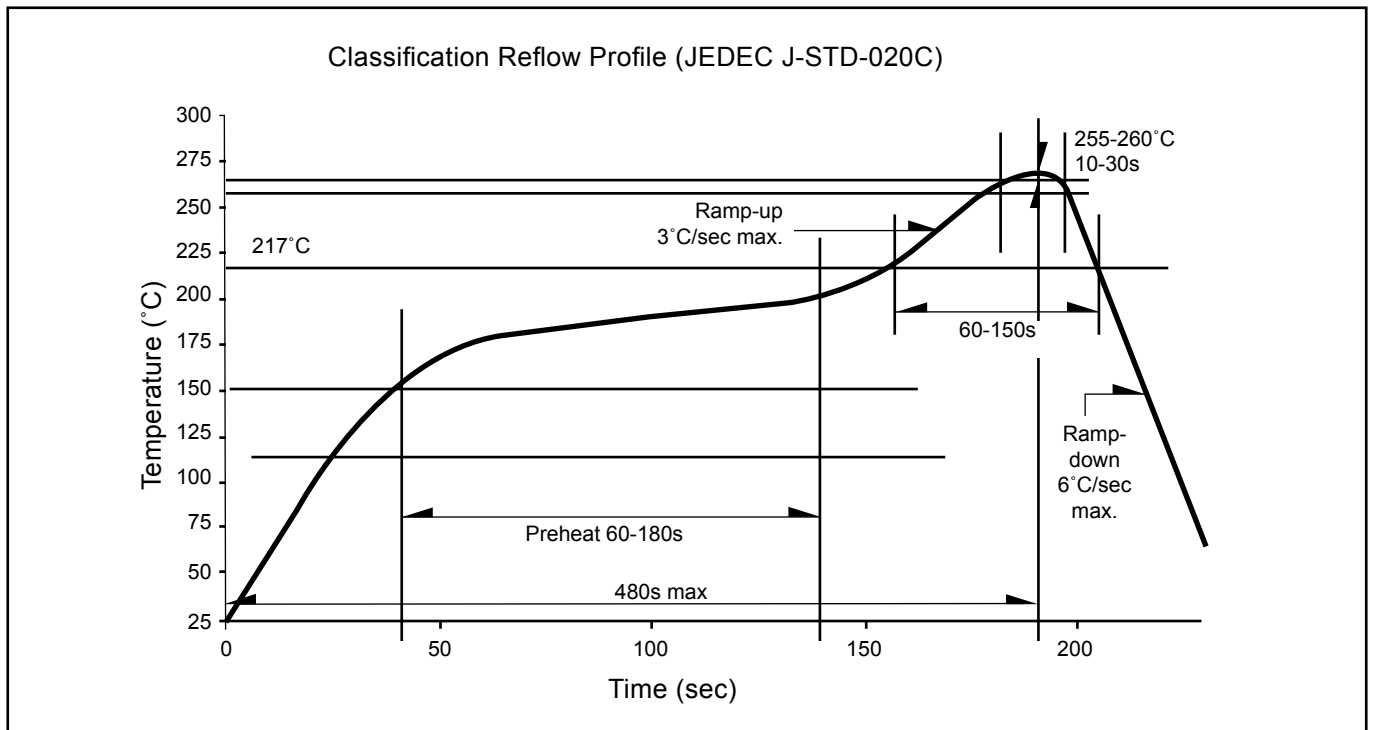

About Us

DOMINANT Semiconductors is a dynamic Malaysian Corporation that is among the world's leading SMT LED Manufacturers. An excellence – driven organization, it offers a comprehensive product range for diverse industries and applications. Featuring an internationally certified quality assurance acclaim, DOMINANT's extra bright LEDs are perfectly suited for various lighting applications in the automotive, consumer and communications as well as industrial sectors. With extensive industry experience and relentless pursuit of innovation, DOMINANT's state-of-art manufacturing, research and testing capabilities have become a trusted and reliable brand across the globe. More information about DOMINANT Semiconductors can be found on the Internet at <http://www.dominant-semi.com>.

Please contact us for more information:

Head Quarter

DOMINANT Semiconductors Sdn. Bhd.
Lot 6, Batu Berendam, FTZ Phase III, 75350 Melaka, Malaysia
Tel: (606) 283 3566 Fax: (606) 283 0566
E-mail: sales@dominant-semi.com

DOMINANT China Sales Office

DOMINANT Semiconductors (Shenzhen) Co. Ltd.
24B.C Newbaohui Building, No. 1007 West Nanhai Blvd., Nanshan, Shenzhen, China P.C. 518054
Tel: +86 (755) 86031785 / +86 (755) 86031786 Fax: +86 (755) 86031789
E-mail: sales_china@dominant-semi.com

DOMINANT Korea Sales Office

DOMINANT Semiconductors Korea Inc.
902 Sunil Technopia, 440 Sangdaewon-dong, Jungwon-gu, Sungnam-si, Kyunggi-do, Korea 462726
Tel: 82-31-777-3978 Fax: 82-31-777-3976
E-mail: sales_korea@dominant-semi.com

