

400W TRANSIENT VOLTAGE SUPPRESSOR

Features

- Glass Passivated Die Construction
- 400W Peak Pulse Power Dissipation
- 6.8V – 440V Standoff Voltage
- Uni- and Bi-Directional Versions Available
- Excellent Clamping Capability
- Fast Response Time
- Plastic Case Material has UL Flammability Classification Rating 94V-O

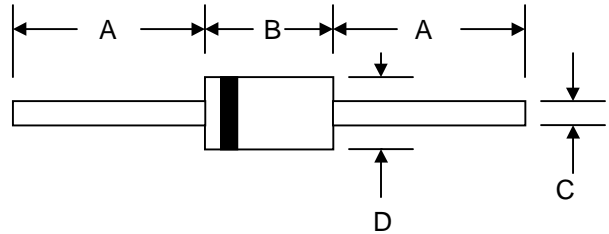

Mechanical Data

- Case: DO-41, Molded Plastic
- Terminals: Axial Leads, Solderable per MIL-STD-202, Method 208
- Polarity: Cathode Band Except Bi-Directional
- Marking: Type Number
- Weight: 0.34 grams (approx.)
- **Lead Free: For RoHS / Lead Free Version, Add "-LF" Suffix to Part Number, See Page 6**

DO-41		
Dim	Min	Max
A	25.4	—
B	4.06	5.21
C	0.71	0.864
D	2.00	2.72
All Dimensions in mm		

"C" Suffix Designates Bi-directional Devices
 "A" Suffix Designates 5% Tolerance Devices
 No Suffix Designates 10% Tolerance Devices

Maximum Ratings and Electrical Characteristics @ $T_A=25^\circ\text{C}$ unless otherwise specified

Characteristic	Symbol	Value	Unit
Peak Pulse Power Dissipation at $T_A = 25^\circ\text{C}$ (Note 1, 2, 5) Figure 3	PPPM	400 Minimum	W
Peak Forward Surge Current (Note 3)	IFSM	40	A
Peak Pulse Current on 10/1000 μS Waveform (Note 1) Figure 1	IPPM	See Table 1	A
Steady State Power Dissipation (Note 2, 4)	PM(AV)	1.0	W
Operating and Storage Temperature Range	T_j, T_{STG}	-65 to +175	$^\circ\text{C}$

- Note: 1. Non-repetitive current pulse per Figure 1 and derated above $T_A = 25^\circ\text{C}$ per Figure 4.
 2. Mounted on 40mm² copper pad.
 3. 8.3ms single half sine-wave duty cycle = 4 pulses per minutes maximum.
 4. Lead temperature at 75 $^\circ\text{C}$.
 5. Peak pulse power waveform is 10/1000 μS .

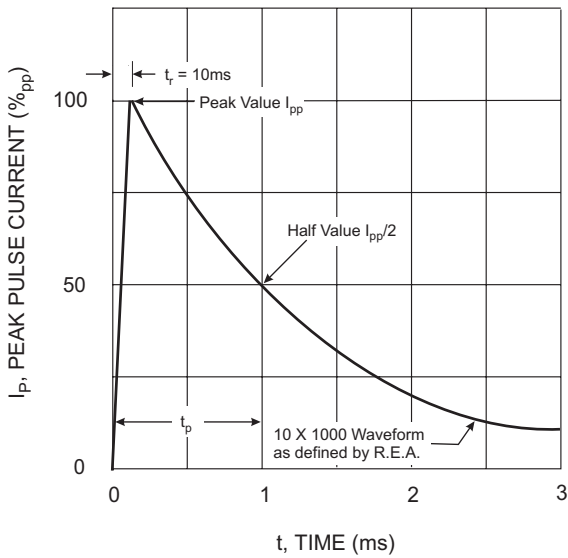

Fig. 1 Pulse Waveform

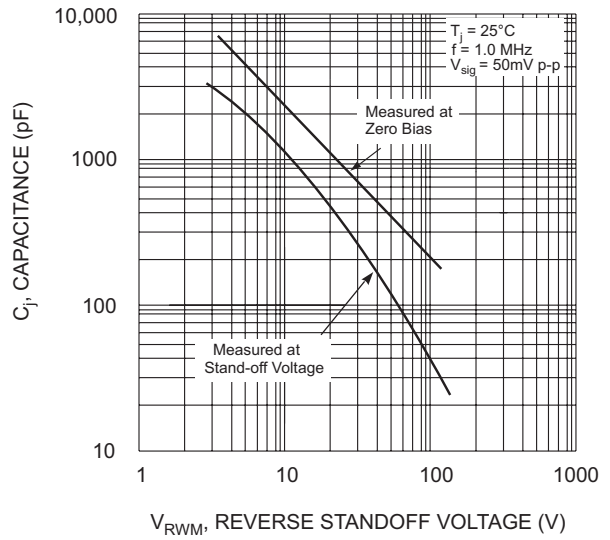

Fig. 2 Typical Junction Capacitance

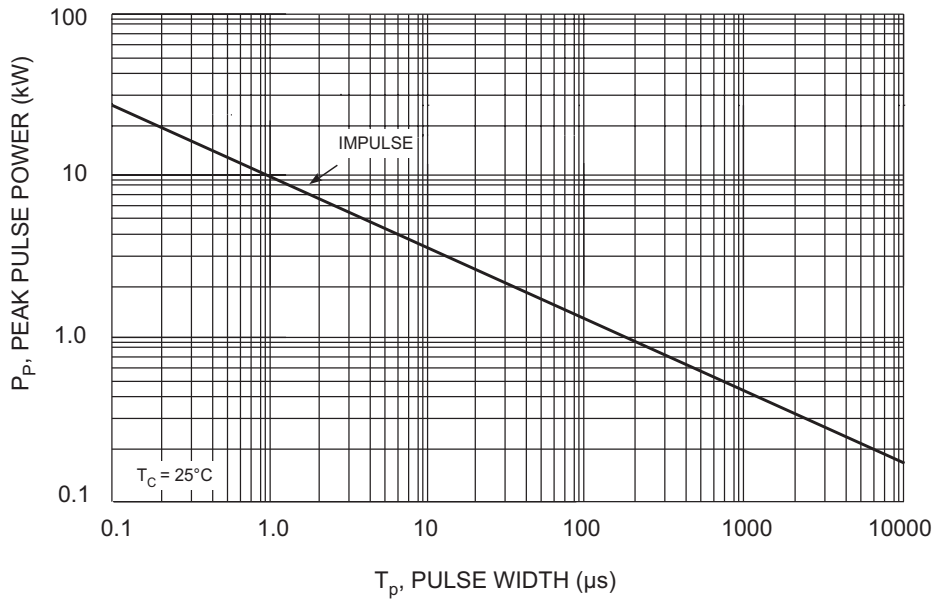

Fig. 3 Pulse Rating Curve

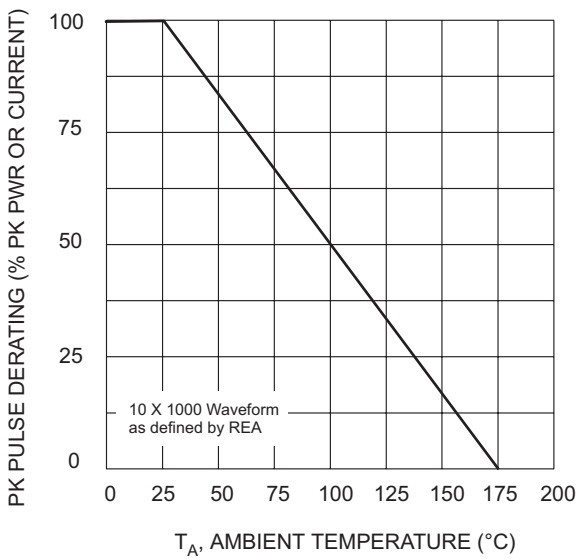

Fig. 4 Pulse Derating Curve

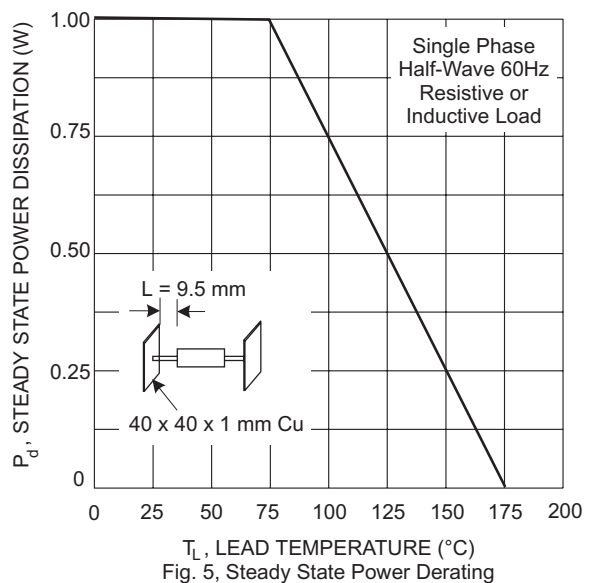

Fig. 5, Steady State Power Derating

UNI-DIRECTIONAL 400 WATT AXIAL LEAD TVS

UNI-DIRECTIONAL PART NUMBER	REVERSE STAND-OFF VOLTAGE VRWM (V)	BREAKDOWN VOLTAGE VBR (V) MIN. @IT	BREAKDOWN VOLTAGE VBR (V) MAX. @IT	TEST CURRENT IT (mA)	MAXIMUM CLAMPING VOLTAGE @Ipp Vc (V)	PEAK PULSE CURRENT Ipp (A)	REVERSE LEAKAGE @VRWM IR (uA)
P4KE6.8	5.50	6.12	7.48	10	10.8	38.00	1000
P4KE6.8A	5.80	6.45	7.14	10	10.5	38.10	1000
P4KE7.5	6.05	6.75	8.25	10	11.7	34.20	500
P4KE7.5A	6.40	7.13	7.88	10	11.3	35.40	500
P4KE8.2	6.63	7.38	9.02	10	12.5	32.00	200
P4KE8.2A	7.02	7.79	8.61	10	12.1	33.10	200
P4KE9.1	7.37	8.19	10.00	1	13.8	29.00	50
P4KE9.1A	7.78	8.65	9.50	1	13.4	29.90	50
P4KE10	8.10	9.00	11.00	1	15.0	26.70	10
P4KE10A	8.55	9.50	10.50	1	14.5	27.60	10
P4KE11	8.92	9.90	12.10	1	16.2	24.70	5
P4KE11A	9.40	10.50	11.60	1	15.6	25.60	5
P4KE12	9.72	10.80	13.20	1	17.3	23.10	1
P4KE12A	10.20	11.40	12.60	1	16.7	24.00	1
P4KE13	10.50	11.70	14.30	1	19.0	21.10	1
P4KE13A	11.10	12.40	13.70	1	18.2	22.00	1
P4KE15	12.10	13.50	16.50	1	22.0	18.20	1
P4KE15A	12.80	14.30	15.80	1	21.2	18.90	1
P4KE16	12.90	14.40	17.60	1	23.5	17.00	1
P4KE16A	13.60	15.20	16.80	1	22.5	17.80	1
P4KE18	14.50	16.20	19.80	1	26.5	15.10	1
P4KE18A	15.30	17.10	18.90	1	25.2	15.90	1
P4KE20	16.20	18.00	22.00	1	29.1	13.70	1
P4KE20A	17.10	19.00	21.00	1	27.7	14.40	1
P4KE22	17.80	19.80	24.20	1	31.9	12.50	1
P4KE22A	18.80	20.90	23.10	1	30.6	13.10	1
P4KE24	19.40	21.60	26.40	1	34.7	11.50	1
P4KE24A	20.50	22.80	25.20	1	33.2	12.00	1
P4KE27	21.80	24.30	29.70	1	39.1	10.20	1
P4KE27A	23.10	25.70	28.40	1	37.5	10.70	1
P4KE30	24.30	27.00	33.00	1	43.5	9.20	1
P4KE30A	25.60	28.50	31.50	1	41.4	9.70	1
P4KE33	26.80	29.70	36.30	1	47.7	8.40	1
P4KE33A	28.20	31.40	34.70	1	45.7	8.80	1
P4KE36	29.10	32.40	39.60	1	52.0	7.70	1
P4KE36A	30.80	34.20	37.80	1	49.9	8.00	1
P4KE39	31.60	35.10	42.90	1	56.4	7.10	1
P4KE39A	33.30	37.10	41.00	1	53.9	7.40	1
P4KE43	34.80	38.70	47.30	1	61.9	6.50	1
P4KE43A	36.80	40.90	45.20	1	59.3	6.70	1
P4KE47	38.10	42.30	51.70	1	67.8	5.90	1
P4KE47A	40.20	44.70	49.40	1	64.8	6.20	1
P4KE51	41.30	45.90	56.10	1	73.5	5.40	1
P4KE51A	43.60	48.50	53.60	1	70.1	5.70	1
P4KE56	45.60	50.40	61.60	1	80.5	5.00	1
P4KE56A	47.80	53.20	58.80	1	77.0	5.20	1
P4KE62	50.20	55.80	68.20	1	89.0	4.50	1
P4KE62A	53.00	58.90	65.10	1	85.0	4.70	1
P4KE68	55.10	61.20	74.80	1	98.0	4.10	1
P4KE68A	58.10	64.60	71.40	1	92.0	4.30	1
P4KE75	60.70	67.50	82.50	1	108.0	3.70	1
P4KE75A	64.10	71.30	78.80	1	103.0	3.90	1
P4KE82	66.40	73.80	90.20	1	118.0	3.40	1
P4KE82A	70.10	77.90	86.10	1	113.0	3.50	1
P4KE91	73.70	81.90	100.00	1	131.0	3.10	1
P4KE91A	77.80	86.50	95.50	1	125.0	3.20	1
P4KE100	81.00	90.00	110.00	1	144.0	2.80	1
P4KE100A	85.50	95.00	105.00	1	137.0	2.90	1
P4KE110	89.20	99.00	121.00	1	158.0	2.50	1
P4KE110A	94.00	105.00	116.00	1	152.0	2.60	1
P4KE120	97.20	108.00	132.00	1	173.0	2.30	1
P4KE120A	102.00	114.00	126.00	1	165.0	2.40	1
P4KE130	105.00	117.00	143.00	1	187.0	2.10	1
P4KE130A	111.00	124.00	137.00	1	179.0	2.20	1
P4KE150	121.00	135.00	165.00	1	215.0	1.90	1
P4KE150A	128.00	143.00	158.00	1	207.0	1.90	1
P4KE160	130.00	144.00	176.00	1	230.0	1.70	1
P4KE160A	136.00	152.00	168.00	1	219.0	1.80	1
P4KE170	138.00	153.00	187.00	1	244.0	1.60	1
P4KE170A	145.00	162.00	179.00	1	234.0	1.70	1
P4KE180	146.00	162.00	198.00	1	258.0	1.60	1
P4KE180A	154.00	171.00	189.00	1	246.0	1.60	1
P4KE200	162.00	180.00	220.00	1	287.0	1.40	1
P4KE200A	171.00	190.00	210.00	1	274.0	1.50	1
P4KE220	175.00	198.00	242.00	1	344.0	1.20	1
P4KE220A	185.00	209.00	231.00	1	328.0	1.20	1
P4KE250	202.00	225.00	275.00	1	360.0	1.10	1
P4KE250A	214.00	237.00	263.00	1	344.0	1.20	1
P4KE300	243.00	270.00	330.00	1	430.0	0.93	1
P4KE300A	256.00	285.00	315.00	1	414.0	1.00	1
P4KE350	284.00	315.00	385.00	1	504.0	0.79	1
P4KE350A	300.00	332.00	368.00	1	482.0	0.83	1
P4KE400	324.00	360.00	440.00	1	574.0	0.70	1
P4KE400A	342.00	380.00	420.00	1	548.0	0.73	1
P4KE440	356.00	396.00	484.00	1	631.0	0.63	1
P4KE440A	376.00	418.00	462.00	1	602.0	0.66	1

BI-DIRECTIONAL 400 WATT AXIAL LEAD TVS

BI-DIRECTIONAL PART NUMBER	REVERSE STAND-OFF VOLTAGE VRWM (V)	BREAKDOWN VOLTAGE VBR (V) MIN. @IT	BREAKDOWN VOLTAGE VBR (V) MAX. @IT	TEST CURRENT IT (mA)	MAXIMUM CLAMPING VOLTAGE @Ipp Vc (V)	PEAK PULSE CURRENT Ipp (A)	REVERSE LEAKAGE @VRWM IR (uA)
P4KE6.8C	5.50	6.12	7.48	10	10.8	38.00	2000
P4KE6.8CA	5.80	6.45	7.14	10	10.5	38.10	2000
P4KE7.5C	6.05	6.75	8.25	10	11.7	34.20	1000
P4KE7.5CA	6.40	7.13	7.88	10	11.3	35.40	1000
P4KE8.2C	6.63	7.38	9.02	10	12.5	32.00	400
P4KE8.2CA	7.02	7.79	8.61	10	12.1	33.10	400
P4KE9.1C	7.37	8.19	10.00	1	13.8	29.00	100
P4KE9.1CA	7.78	8.65	9.50	1	13.4	29.90	100
P4KE10C	8.10	9.00	11.00	1	15.0	26.70	20
P4KE10CA	8.55	9.50	10.50	1	14.5	27.60	20
P4KE11C	8.92	9.90	12.10	1	16.2	24.70	10
P4KE11CA	9.40	10.50	11.60	1	15.6	25.60	10
P4KE12C	9.72	10.80	13.20	1	17.3	23.10	1
P4KE12CA	10.20	11.40	12.60	1	16.7	24.00	1
P4KE13C	10.50	11.70	14.30	1	19.0	21.10	1
P4KE13CA	11.10	12.40	13.70	1	18.2	22.00	1
P4KE15C	12.10	13.50	16.50	1	22.0	18.20	1
P4KE15CA	12.80	14.30	15.80	1	21.2	18.90	1
P4KE16C	12.90	14.40	17.60	1	23.5	17.00	1
P4KE16CA	13.60	15.20	16.80	1	22.5	17.80	1
P4KE18C	14.50	16.20	19.80	1	26.5	15.10	1
P4KE18CA	15.30	17.10	18.90	1	25.2	15.90	1
P4KE20C	16.20	18.00	22.00	1	29.1	13.70	1
P4KE20CA	17.10	19.00	21.00	1	27.7	14.40	1
P4KE22C	17.80	19.80	24.20	1	31.9	12.50	1
P4KE22CA	18.80	20.90	23.10	1	30.6	13.10	1
P4KE24C	19.40	21.60	26.40	1	34.7	11.50	1
P4KE24CA	20.50	22.80	25.20	1	33.2	12.00	1
P4KE27C	21.80	24.30	29.70	1	39.1	10.20	1
P4KE27CA	23.10	25.70	28.40	1	37.5	10.70	1
P4KE30C	24.30	27.00	33.00	1	43.5	9.20	1
P4KE30CA	25.60	28.50	31.50	1	41.4	9.70	1
P4KE33C	26.80	29.70	36.30	1	47.7	8.40	1
P4KE33CA	28.20	31.40	34.70	1	45.7	8.80	1
P4KE36C	29.10	32.40	39.60	1	52.0	7.70	1
P4KE36CA	30.80	34.20	37.80	1	49.9	8.00	1
P4KE39C	31.60	35.10	42.90	1	56.4	7.10	1
P4KE39CA	33.30	37.10	41.00	1	53.9	7.40	1
P4KE43C	34.80	38.70	47.30	1	61.9	6.50	1
P4KE43CA	36.80	40.90	45.20	1	59.3	6.70	1
P4KE47C	38.10	42.30	51.70	1	67.8	5.90	1
P4KE47CA	40.20	44.70	49.40	1	64.8	6.20	1
P4KE51C	41.30	45.90	56.10	1	73.5	5.40	1
P4KE51CA	43.60	48.50	53.60	1	70.1	5.70	1
P4KE56C	45.60	50.40	61.60	1	80.5	5.00	1
P4KE56CA	47.80	53.20	58.80	1	77.0	5.20	1
P4KE62C	50.20	55.80	68.20	1	89.0	4.50	1
P4KE62CA	53.00	58.90	65.10	1	85.0	4.70	1
P4KE68C	55.10	61.20	74.80	1	98.0	4.10	1
P4KE68CA	58.10	64.60	71.40	1	92.0	4.30	1
P4KE75C	60.70	67.50	82.50	1	108.0	3.70	1
P4KE75CA	64.10	71.30	78.80	1	103.0	3.90	1
P4KE82C	66.40	73.80	90.20	1	118.0	3.40	1
P4KE82CA	70.10	77.90	86.10	1	113.0	3.50	1
P4KE91C	73.70	81.90	100.00	1	131.0	3.10	1
P4KE91CA	77.80	86.50	95.50	1	125.0	3.20	1
P4KE100C	81.00	90.00	110.00	1	144.0	2.80	1
P4KE100CA	85.50	95.00	105.00	1	137.0	2.90	1
P4KE110C	89.20	99.00	121.00	1	158.0	2.50	1
P4KE110CA	94.00	105.00	116.00	1	152.0	2.60	1
P4KE120C	97.20	108.00	132.00	1	173.0	2.30	1
P4KE120CA	102.00	114.00	126.00	1	165.0	2.40	1
P4KE130C	105.00	117.00	143.00	1	187.0	2.10	1
P4KE130CA	111.00	124.00	137.00	1	179.0	2.20	1
P4KE150C	121.00	135.00	165.00	1	215.0	1.90	1
P4KE150CA	128.00	143.00	158.00	1	207.0	1.90	1
P4KE160C	130.00	144.00	176.00	1	230.0	1.70	1
P4KE160CA	136.00	152.00	168.00	1	219.0	1.80	1
P4KE170C	138.00	153.00	187.00	1	244.0	1.60	1
P4KE170CA	145.00	162.00	179.00	1	234.0	1.70	1
P4KE180C	146.00	162.00	198.00	1	258.0	1.60	1
P4KE180CA	154.00	171.00	189.00	1	246.0	1.60	1
P4KE200C	162.00	180.00	220.00	1	287.0	1.40	1
P4KE200CA	171.00	190.00	210.00	1	274.0	1.50	1
P4KE220C	175.00	198.00	242.00	1	344.0	1.20	1
P4KE220CA	185.00	209.00	231.00	1	328.0	1.20	1
P4KE250C	202.00	225.00	275.00	1	360.0	1.10	1
P4KE250CA	214.00	237.00	263.00	1	344.0	1.20	1
P4KE300C	243.00	270.00	330.00	1	430.0	0.93	1
P4KE300CA	256.00	285.00	315.00	1	414.0	1.00	1
P4KE350C	284.00	315.00	385.00	1	504.0	0.79	1
P4KE350CA	300.00	332.00	368.00	1	482.0	0.83	1
P4KE400C	324.00	360.00	440.00	1	574.0	0.70	1
P4KE400CA	342.00	380.00	420.00	1	548.0	0.73	1
P4KE440C	356.00	396.00	484.00	1	631.0	0.63	1
P4KE440CA	376.00	418.00	462.00	1	602.0	0.66	1

MARKING INFORMATION

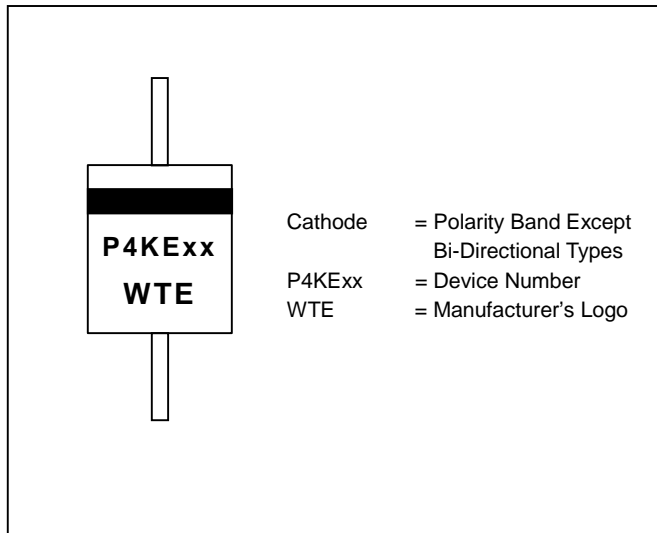

TAPING SPECIFICATIONS

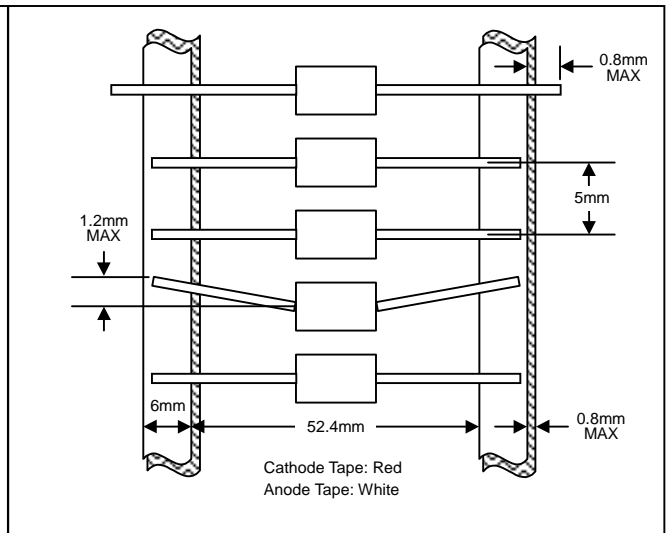

PACKAGING INFORMATION

TAPE & REEL

330mm
 Product ID Label
 80±5mm

TAPE & BOX

150mm
 Product ID Label
 Inspection Hole (both ends)
 255mm
 75mm

BULK

20mm
 198mm
 84mm

Packaging	Reel Diameter / Box Size (mm)	Quantity (PCS)	Carton Size (mm)	Quantity (PCS)	Approx. Gross Weight (KG)
TAPE & REEL	330	5,000	370 x 370 x 420	25,000	13.0
TAPE & BOX	255 x 75 x 150	5,000	400 x 273 x 415	50,000	21.0
BULK	198 x 84 x 20	1,000	459 x 214 x 256	50,000	19.5

Note: 1. Paper reel, white or gray color. Core material: plastic or metal.
 2. Components are packed in accordance with EIA standard RS-296-E.

ORDERING INFORMATION

Product No.	Package Type	Shipping Quantity
P4KExx-T3	DO-41	5000/Tape & Reel
P4KExx-TB	DO-41	5000/Tape & Box
P4KExx	DO-41	1000 Units/Box

1. Products listed in **bold** are WTE **Preferred** devices.
2. Shipping quantity given is for minimum packing quantity only. For minimum order quantity, please consult the Sales Department.
3. **To order RoHS / Lead Free version, add "-LF" suffix to part number above. For example, P4KE6.8-TB-LF.**

Won-Top Electronics Co., Ltd (WTE) has checked all information carefully and believes it to be correct and accurate. However, WTE cannot assume any responsibility for inaccuracies. Furthermore, this information does not give the purchaser of semiconductor devices any license under patent rights to manufacturer. WTE reserves the right to change any or all information herein without further notice.

WARNING: DO NOT USE IN LIFE SUPPORT EQUIPMENT. WTE power semiconductor products are not authorized for use as critical components in life support devices or systems without the express written approval.

Won-Top Electronics Co., Ltd.

No. 44 Yu Kang North 3rd Road, Chine Chen Dist., Kaohsiung, Taiwan

Phone: 886-7-822-5408 or 886-7-822-5410

Fax: 886-7-822-5417

Email: sales@wontop.com

Internet: <http://www.wontop.com>

We power your everyday.