





# SMT POWER INDUCTORS

## Unshielded Drum Core - PF0638NL Series



-  All Inductors are RoHS compliant
-  Footprint: 13.21mm x 9.91mm Max
-  Current Rating: up to 17A
-  Inductance Range: 0.12μH to 10μH
-  260°C reflow peak temperature qualified

### Electrical Specifications @ 25°C — Operating Temperature -40°C to +125°C

Part <sup>4</sup> Number	Inductance @0Adc (μH ±20%)	I <sub>rated</sub> <sup>1</sup> (A)	DCR (mΩ MAX)	Saturation <sup>2</sup> Current I <sub>sat</sub> (A)	Heating <sup>3</sup> Current I <sub>dc</sub> (A)	SRF (MHz TYP)
PF0638.121NL	0.12	17	1.5	28	17	200
PF0638.331NL	0.33	16	2	20	16	200
PF0638.681NL	0.68	12	5	13	12	150
PF0638.102NL	1.0	10	6	11	10	100
PF0638.152NL	1.5	9	10	9	9	90
PF0638.222NL	2.2	7.4	11	7.8	7.4	80
PF0638.272NL	2.7	6.6	12	7	6.6	65
PF0638.332NL	3.3	5.9	14	6.4	5.9	60
PF0638.392NL	3.9	5.3	15	5.9	5.3	50
PF0638.472NL	4.7	4.8	18	5.4	4.8	45
PF0638.682NL	6.8	4.4	25	4.6	4.4	40
PF0638.103NL	10	3.7	34	4	3.7	32

### Mechanical

### Schematic

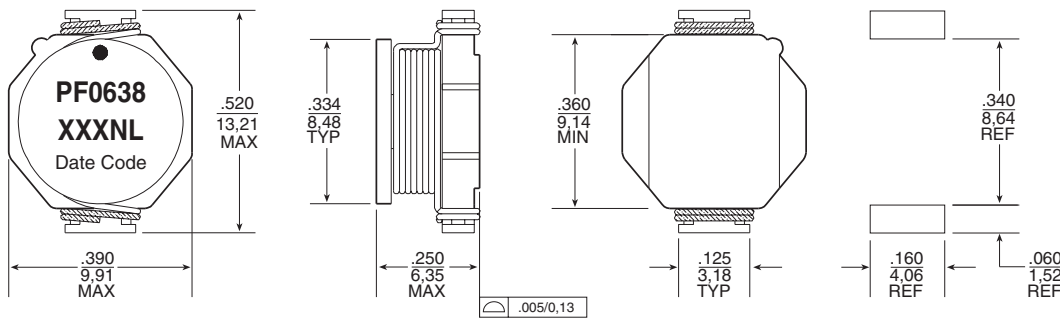

SUGGESTED PAD LAYOUT

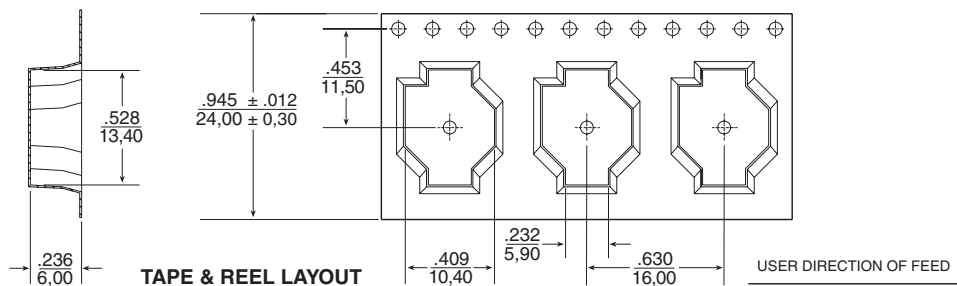

TAPE & REEL LAYOUT

Weight .....1.3 grams  
Tape & Reel.....600/reel

Dimensions: Inches  
mm  
Unless otherwise specified,  
all tolerances are ± .004  
0,10

# SMT POWER INDUCTORS

## Unshielded Drum Core - PF0638NL Series



### Notes from Tables

1. The rated current as listed is either the saturation current @ 25°C or the heating current depending on which value is lower.
2. The saturation current  $I_{sat}$  is the current which causes the inductance to drop by 10% typical at an ambient temperature of 25°C. This current is determined by placing the component in the specified ambient environment and applying a short duration pulse current (to eliminate self-heating effects) to the component.
3. The heating current  $I_{dc}$  is the dc current which causes the temperature rise of the part to increase by approximately 40°C. This current is determined by mounting the component on a typical application PCB and applying the current to the device for 30 minutes.
4. Optional Tape and Reel packaging can be ordered by adding a "T" suffix to the part number (i.e. PF0638.103NL becomes PF0638.103NLT). Pulse complies to industry standard tape and reel specification EIA481.

### Typical Inductance vs Current Characteristics

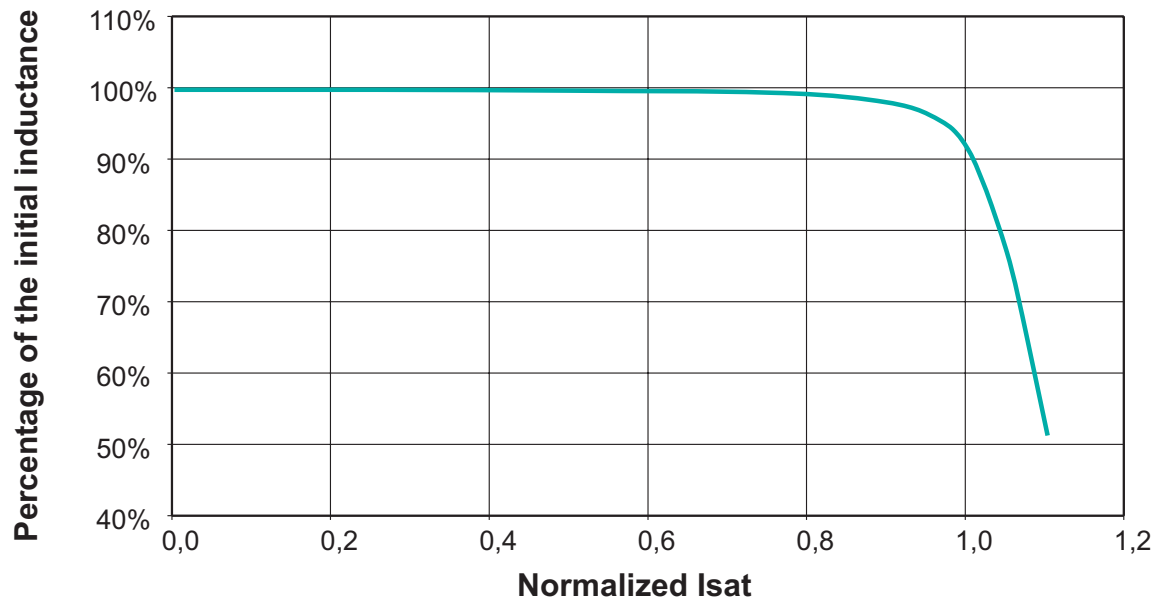

### For More Information:

Pulse Worldwide Headquarters	Pulse Northern Europe	Pulse Southern Europe	Pulse China Headquarters	Pulse North China	Pulse South Asia	Pulse North Asia
12220 World Trade Drive San Diego, CA 92128 U.S.A. <a href="http://www.pulseeng.com">www.pulseeng.com</a> TEL: 858 674 8100 FAX: 858 674 8262	3 Huxley Road Surrey Research Park Guildford, Surrey GU2 5RE United Kingdom TEL: 44 1483 401700 FAX: 44 1483 401701	Zone Industrielle F-39270 Orgelet France TEL: 33 3 84 35 04 04 FAX: 33 3 84 25 46 41	No. 1 Industrial District Changan, Dongguan China TEL: 86 769 85538070 FAX: 86 769 85538870	Room 1503 XinYin Building No. 888 YiShan Road Shanghai 200233 China TEL: 86 21 54643211/2 FAX: 86 21 54643210	150 Kampong Ampat #07-01/02 KA Centre Singapore 368324 TEL: 65 6287 8998 FAX: 65 6280 0080	No. 26 Kao Ching Road Yang Mei Chen Taoyuan Hsien Taiwan, R. O. C. TEL: 886 3 4641811 FAX: 886 3 4641911

Performance warranty of products offered on this data sheet is limited to the parameters specified. Data is subject to change without notice. Other brand and product names mentioned herein may be trademarks or registered trademarks of their respective owners.

© Copyright, 2006. Pulse Engineering, Inc. All rights reserved.