

## PF08134B

### MOS FET Power Amplifier Module for GSM850 and DCS1800/1900 Triple Band Handy Phone

REJ03G0075-0101Z

Rev.1.01

May 13, 2004

#### Application

- Triple band amplifier for GSM850 (824 MHz to 849 MHz) and DCS1800/1900 (1710 MHz to 1785 MHz, 1850 MHz to 1910 MHz).
- For 3.5 V & GPRS Class12 operation compatible

#### Features

- All in one including output matching circuit
- Simple external circuit
- Simple power control
- High gain 3stage amplifier : 0 dBm input Typ
- Lead less thin & Small package : 8.0 × 10.0 × 1.5 mm Max
- High efficiency
  - 47% Typ at 33.5 dBm for GSM850
  - 47% Typ at 32.5 dBm for DCS1800
  - 47% Typ at 32.0 dBm for DCS1900

#### Pin Arrangement

• RF-Q-8

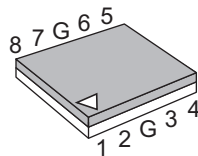

- 1: Pin<sub>GSM</sub>
- 2: V<sub>apc</sub>
- 3: V<sub>dd1</sub>
- 4: P<sub>out GSM</sub>
- 5: P<sub>out DCS</sub> & P<sub>out PCS</sub>
- 6: V<sub>dd2</sub>
- 7: V<sub>ctl</sub>
- 8: Pin<sub>DCS</sub> & Pin<sub>PCS</sub>
- G: GND

**Absolute Maximum Ratings** \*1

(Tc = 25°C)

Item	Symbol	Rating	Unit	Remark
Supply voltage	Vdd	7.0	V	at no-operation
		5.0	V	at operation (50 Ω load)
Supply current	I <sub>dd</sub> <sub>GSM</sub>	3.5	A	
	I <sub>dd</sub> <sub>DCS</sub>	2	A	
Vctl voltage	Vctl	4	V	
Vapc voltage	Vapc	4	V	
Input power	Pin	10	dBm	
Operating case temperature *2	Tc (op)	-30 to +100	°C	
Storage temperature	Tstg	-40 to +100	°C	
Output power	P <sub>out</sub> <sub>GSM</sub>	5	W	
	P <sub>out</sub> <sub>DCS</sub>	3	W	

Notes: 1. The maximum ratings shall be valid over both the GSM850-band (824 to 849 MHz), and the DCS1800/1900-band (1710 to 1785 MHz, 1850 to 1910 MHz).

2. These are specified at pulsed operation with pulse width = 1154 μs and duty cycle of 2:8.

**Electrical Characteristics for DC**

(Tc = 25°C)

Item	Symbol	Min	Typ	Max	Unit	Test Condition
Drain cutoff current	I <sub>ds</sub>	—	—	20	μA	Vdd = 4.7 V, Vapc = 0 V, Vctl = 0.2 V
Vapc control current	I <sub>apc</sub>	—	—	2.0	mA	Vapc = 2.2 V
Vctl control current	I <sub>ctl</sub>	—	—	2	μA	Vctl = 3 V

## Electrical Characteristics for GSM850 band

(Tc = 25°C)

Test conditions unless otherwise noted:

f = 824 to 849 MHz, Vdd1 = Vdd2 = 3.5 V, Pin = 0 dBm, Vctl = 2.0 V, Rg = Rl = 50 Ω, Tc = 25°C,

Pulse operation with pulse width 1154 μs and duty cycle 2:8 shall be used.

Item	Symbol	Min	Typ	Max	Unit	Test Condition
Frequency range	f	824	—	849	MHz	
Band select (GSM active)	Vctl	2.0	—	2.8	V	
Input power	Pin	-2	—	2	dBm	
Control voltage range	Vapc	0.2	—	2.2	V	
Supply voltage	Vdd	3.1	3.5	4.5	V	
Total efficiency	$\eta_T$	40	47	—	%	Pout <sub>GSM</sub> = 33.5 dBm, Vapc controlled
2nd harmonic distortion	2nd H.D.	—	-10.5	-2.5	dBm	
3rd harmonic distortion	3rd H.D.	—	-16.5	-2.5	dBm	
4th~8th harmonic distortion	4th~8th H.D.	—	—	-2.5	dBm	
Input VSWR	VSWR (in)	—	1.5	3	—	
Output power (1)	Pout (1)	33.5	34.0	—	dBm	Vapc = 2.2 V
Output power (2)	Pout (2)	32.0	32.5	—	dBm	Vdd = 3.1 V, Vapc = 2.2 V, Tc = +85°C
Idd at Low power	—	—	—	300	mA	Pout <sub>GSM</sub> = 7 dBm
Isolation	—	—	-48	-37	dBm	Vapc = 0.2 V
Isolation at DCS RF-output when GSM is active	—	—	-25	-18	dBm	Pout <sub>GSM</sub> = 33.5 dBm, Measured at f = 1648 to 1698 MHz
Switching time	t <sub>r</sub> , t <sub>f</sub>	—	1	2	μs	Pout <sub>GSM</sub> = 5 to 33.5 dBm
Stability	—	No parasitic oscillation < -36 dBm			—	Vdd = 3.1 to 4.5 V, Pout <sub>GSM</sub> ≤ 33.5 dBm, Vapc <sub>GSM</sub> ≤ 2.2 V, Rg = 50 Ω, Output VSWR = 6 : 1 All phase angles
Load VSWR tolerance	—	No degradation or Permanent degradation			—	Vdd = 3.1 to 4.5 V, Pout <sub>GSM</sub> ≤ 33.5 dBm, Vapc <sub>GSM</sub> ≤ 2.2 V, Rg = 50 Ω, t = 20 sec., Output VSWR = 10 : 1 All phase angles
Load VSWR tolerance at GPRS CLASS 12 operation	—	No degradation or Permanent degradation			—	Vdd = 3.1 to 4.2 V, Pout <sub>GSM</sub> ≤ 33.5 dBm, Vapc <sub>GSM</sub> ≤ 2.2 V, Rg = 50 Ω, t = 20 sec., Tc ≤ 90°C, Output VSWR = 10 : 1 All phase angles
Slope Pout/Vapc	—	—	160	200	dB/V	Pout <sub>GSM</sub> = 5 to 33.5 dBm
AM output	—	—	15	20	%	Pout <sub>GSM</sub> = 5 to 33.5 dBm, 4% AM modulation at input 50 kHz modulation frequency

## Electrical Characteristics for DCS1800 band

(Tc = 25°C)

Test conditions unless otherwise noted:

f = 1710 to 1785 MHz, Vdd1 = Vdd2 = 3.5 V, Pin = 0 dBm, Vctl = 0 V, Rg = Rl = 50 Ω, Tc = 25°C,

Pulse operation with pulse width 1154 μs and duty cycle 2:8 shall be used.

Item	Symbol	Min	Typ	Max	Unit	Test Condition
Frequency range	f	1710	—	1785	MHz	
Band select (DCS active)	Vctl	0	—	0.1	V	
Input power	Pin	-2	—	2	dBm	
Control voltage range	Vapc	0.2	—	2.2	V	
Supply voltage	Vdd	3.1	3.5	4.5	V	
Total efficiency	$\eta_T$	40	47	—	%	Pout <sub>DCS</sub> = 32.5 dBm, Vapc controlled
2nd harmonic distortion	2nd H.D.	—	-14.5	-2.5	dBm	
3rd harmonic distortion	3rd H.D.	—	-7.5	-2.5	dBm	
4th~8th harmonic distortion	4th~8th H.D.	—	—	-2.5	dBm	
Input VSWR	VSWR (in)	—	1.5	3	—	
Output power (1)	Pout (1)	32.5	33.5	—	dBm	Vapc = 2.2 V
Output power (2)	Pout (2)	31.0	32.0	—	dBm	Vdd = 3.1 V, Vapc = 2.2 V, Tc = +85°C
Idd at Low power	—	—	—	150	mA	Pout <sub>DCS</sub> = 5 dBm
Isolation	—	—	-42	-37	dBm	Vapc = 0.2 V
Switching time	t <sub>r</sub> , t <sub>f</sub>	—	1	2	μs	Pout <sub>DCS</sub> = 0 to 32.5 dBm
Stability	—	No parasitic oscillation < -36 dBm			—	Vdd = 3.1 to 4.5 V, Pout <sub>DCS</sub> ≤ 32.5 dBm, Vapc <sub>DCS</sub> ≤ 2.2 V, Rg = 50 Ω, Output VSWR = 6 : 1 All phase angles
Load VSWR tolerance	—	No degradation or Permanent degradation			—	Vdd = 3.1 to 4.5 V, Pout <sub>DCS</sub> ≤ 32.5 dBm, Vapc <sub>DCS</sub> ≤ 2.2 V, Rg = 50 Ω, t = 20 sec., Output VSWR = 10 : 1 All phase angles
Load VSWR tolerance at GPRS CLASS 12 operation	—	No degradation or Permanent degradation			—	Vdd = 3.1 to 4.2 V, Pout <sub>DCS</sub> ≤ 32.5 dBm, Vapc <sub>DCS</sub> ≤ 2.2 V, Rg = 50 Ω, t = 20 sec., Tc ≤ 90°C, Output VSWR = 10 : 1 All phase angles
Slope Pout/Vapc	—	—	160	200	dB/V	Pout <sub>DCS</sub> = 0 to 32.5 dBm
AM output	—	—	15	20	%	Pout <sub>DCS</sub> = 0 to 32.5 dBm, 4% AM modulation at input 50 kHz modulation frequency

## Electrical Characteristics for DCS1900 band

(Tc = 25°C)

Test conditions unless otherwise noted:

f = 1850 to 1910 MHz, Vdd1 = Vdd2 = 3.5 V, Pin = 0 dBm, Vctl = 0 V, Rg = Rl = 50 Ω, Tc = 25°C,

Pulse operation with pulse width 1154 μs and duty cycle 2:8 shall be used.

Item	Symbol	Min	Typ	Max	Unit	Test Condition
Frequency range	f	1850	—	1910	MHz	
Band select (DCS active)	Vctl	0	—	0.1	V	
Input power	Pin	-2	—	2	dBm	
Control voltage range	Vapc	0.2	—	2.2	V	
Supply voltage	Vdd	3.1	3.5	4.5	V	
Total efficiency	$\eta_T$	40	47	—	%	Pout <sub>DCS</sub> = 32.0 dBm, Vapc controlled
2nd harmonic distortion	2nd H.D.	—	-15	-3	dBm	
3rd harmonic distortion	3rd H.D.	—	-8	-3	dBm	
4th~8th harmonic distortion	4th~8th H.D.	—	—	-3	dBm	
Input VSWR	VSWR (in)	—	1.5	3	—	
Output power (1)	Pout (1)	32.0	33.0	—	dBm	Vapc = 2.2 V
Output power (2)	Pout (2)	30.5	31.5	—	dBm	Vdd = 3.1 V, Vapc = 2.2 V, Tc = +85°C
Idd at Low power	—	—	—	150	mA	Pout <sub>DCS</sub> = 5 dBm
Isolation	—	—	-42	-37	dBm	Vapc = 0.2 V
Switching time	t <sub>r</sub> , t <sub>f</sub>	—	1	2	μs	Pout <sub>DCS</sub> = 0 to 32.0 dBm
Stability	—	No parasitic oscillation < -36 dBm			—	Vdd = 3.1 to 4.5 V, Pout <sub>DCS</sub> ≤ 32.0 dBm, Vapc <sub>DCS</sub> ≤ 2.2 V, Rg = 50 Ω, Output VSWR = 6 : 1 All phase angles
Load VSWR tolerance	—	No degradation or Permanent degradation			—	Vdd = 3.1 to 4.5 V, Pout <sub>DCS</sub> ≤ 32.0 dBm, Vapc <sub>DCS</sub> ≤ 2.2 V, Rg = 50 Ω, t = 20 sec., Output VSWR = 10 : 1 All phase angles
Load VSWR tolerance at GPRS CLASS 12 operation	—	No degradation or Permanent degradation			—	Vdd = 3.1 to 4.2 V, Pout <sub>DCS</sub> ≤ 32.0 dBm, Vapc <sub>DCS</sub> ≤ 2.2 V, Rg = 50 Ω, t = 20 sec., Tc ≤ 90°C, Output VSWR = 10 : 1 All phase angles
Slope Pout/Vapc	—	—	160	200	dB/V	Pout <sub>DCS</sub> = 0 to 32.0 dBm
AM output	—	—	15	20	%	Pout <sub>DCS</sub> = 0 to 32.0 dBm, 4% AM modulation at input 50 kHz modulation frequency

Circuit Diagram

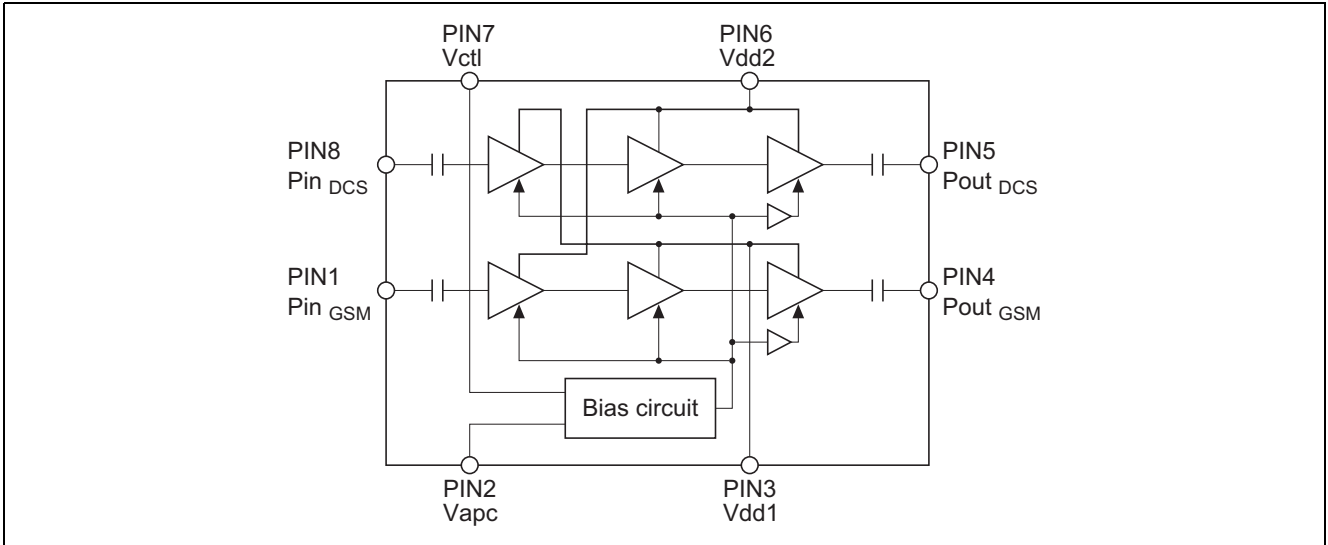

## Characteristic Curves

### GSM mode (824 MHz to 849 MHz)

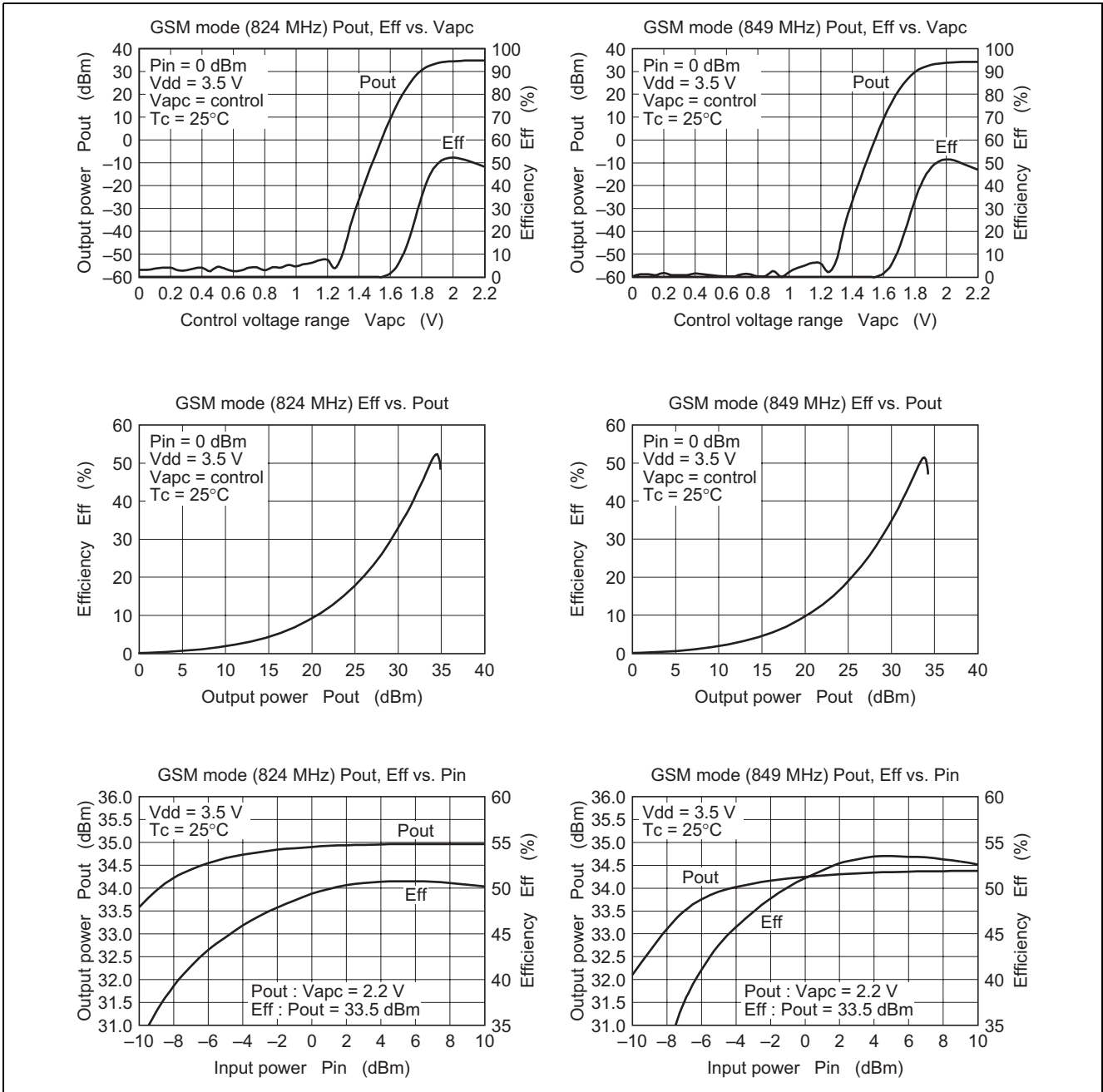

GSM mode (824 MHz to 849 MHz) (cont.)

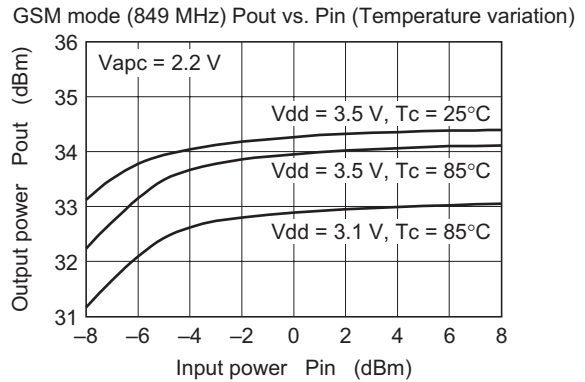
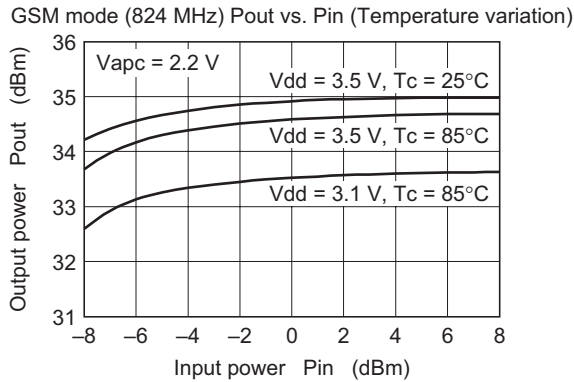
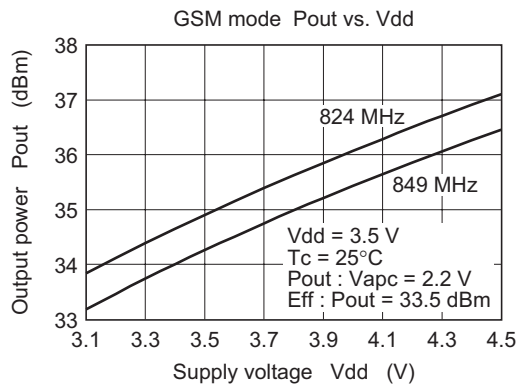
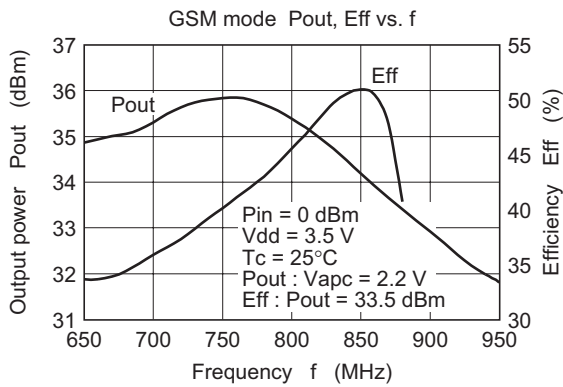
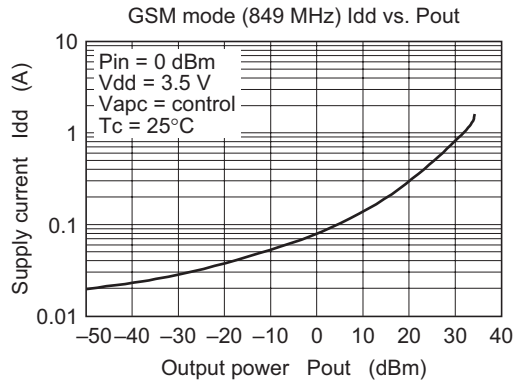
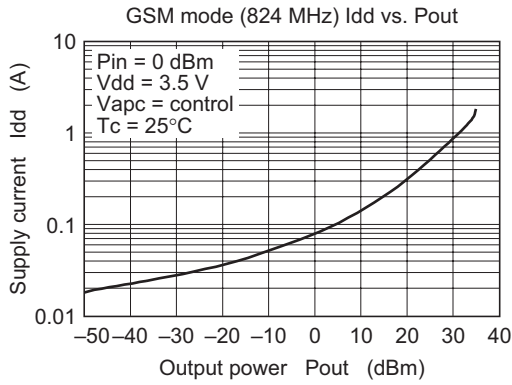



DCS mode (1710 MHz to 1785 MHz)

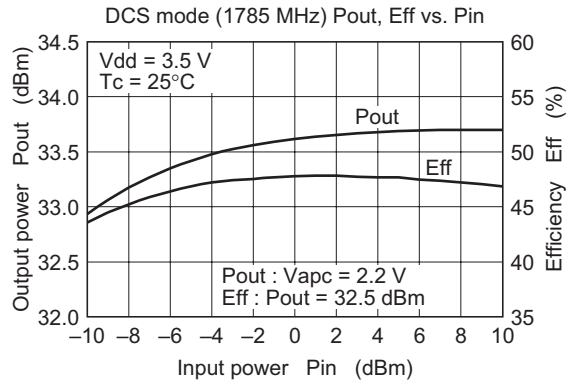
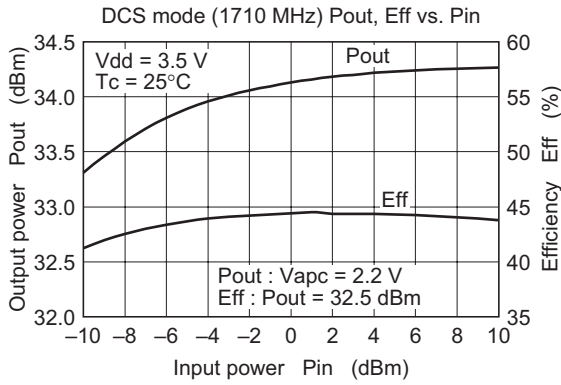
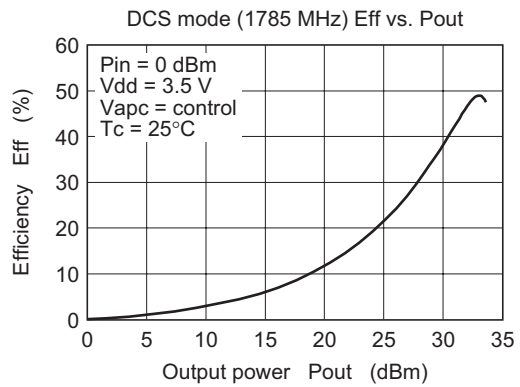
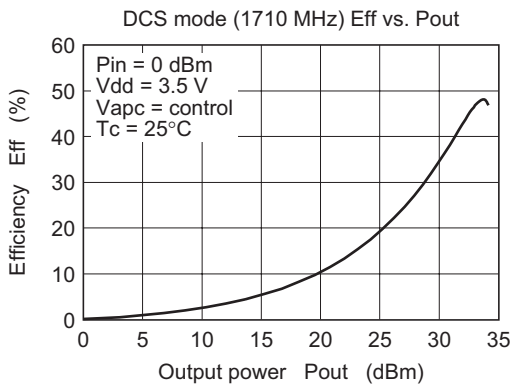
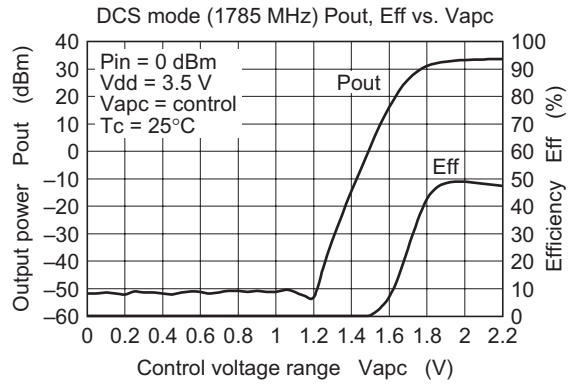
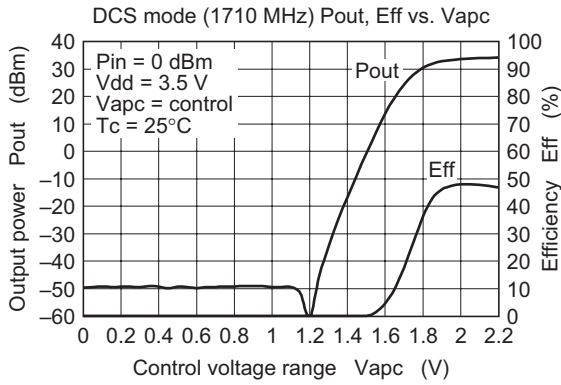

DCS mode (1710 MHz to 1785 MHz) (cont.)

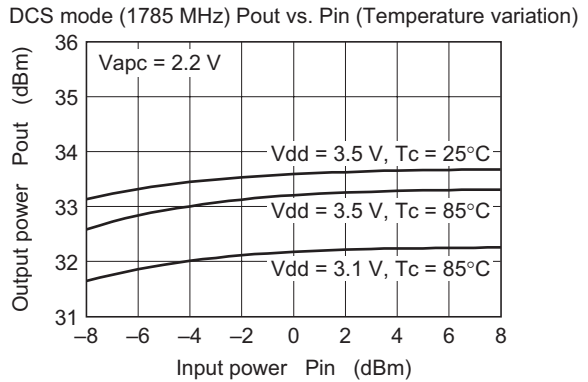
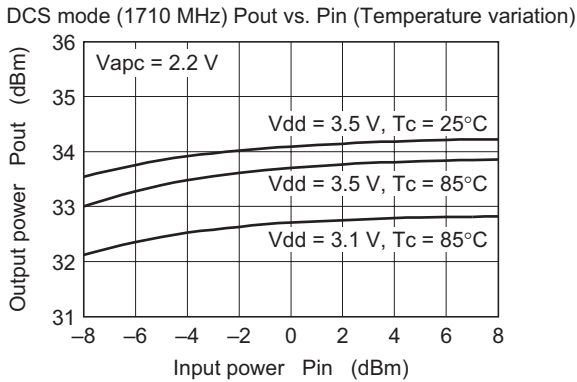
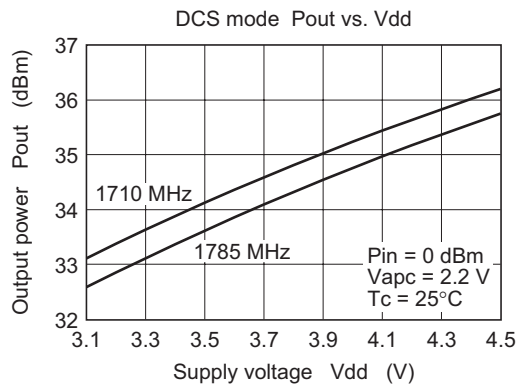
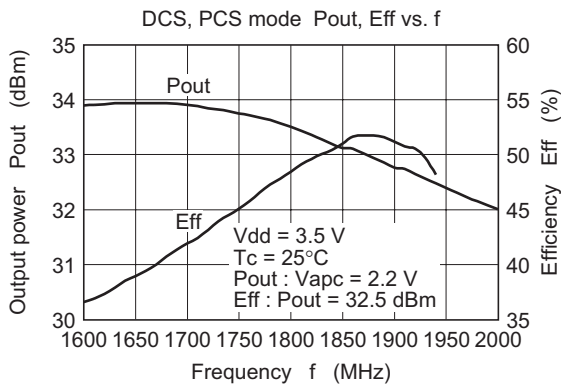
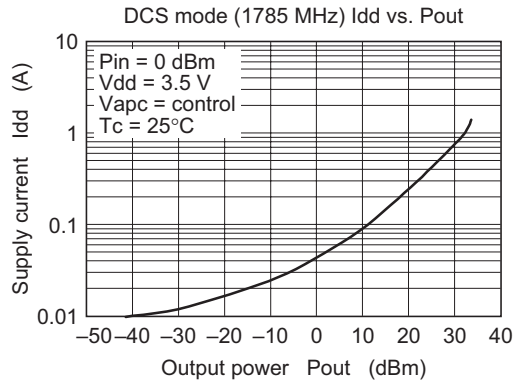
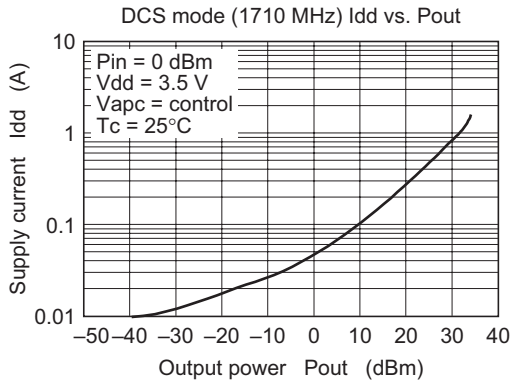

PCS mode (1850 MHz to 1910 MHz)

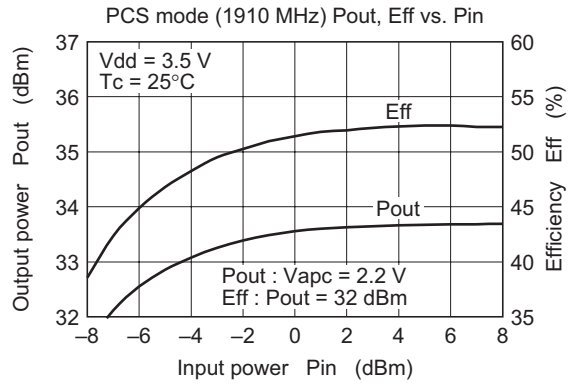
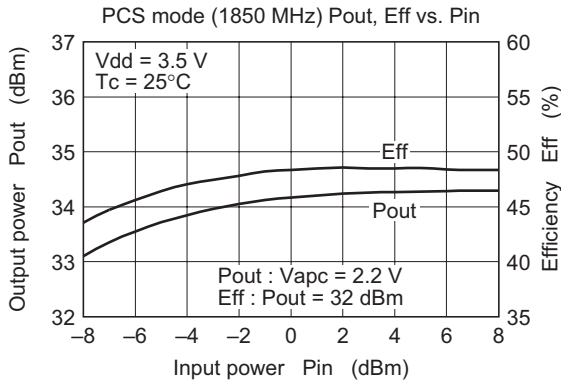
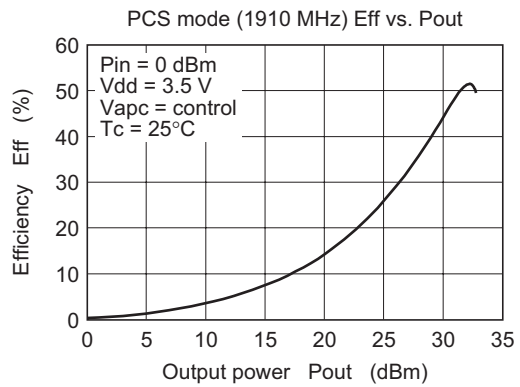
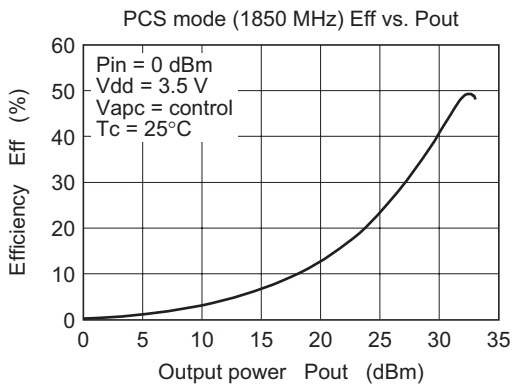
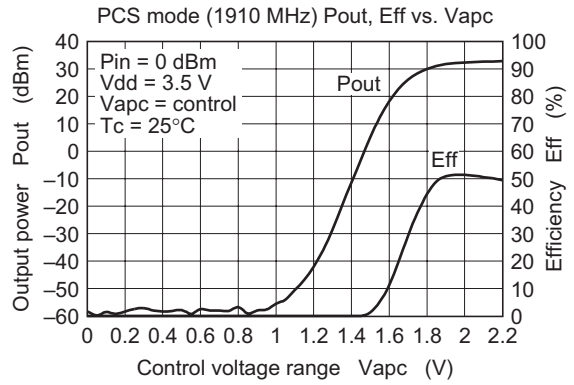
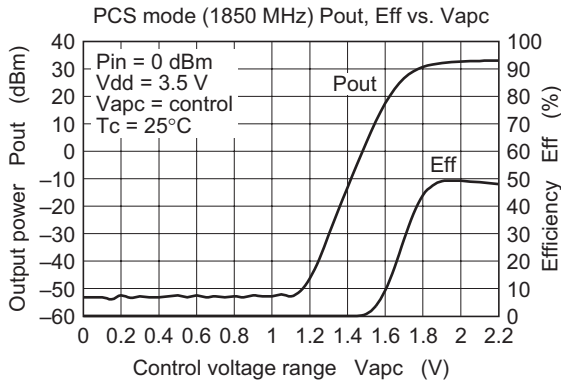

PCS mode (1850 MHz to 1910 MHz) (cont.)

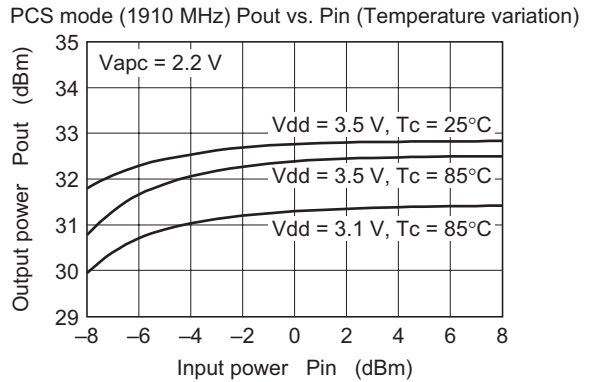
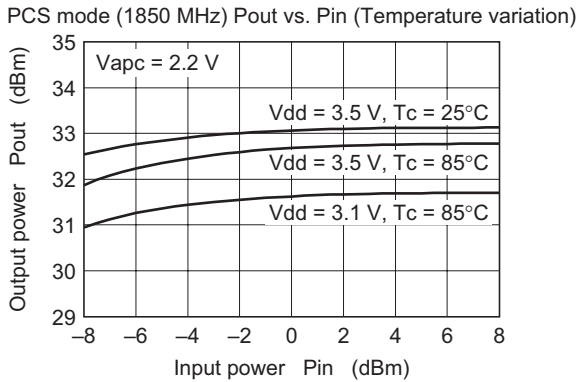
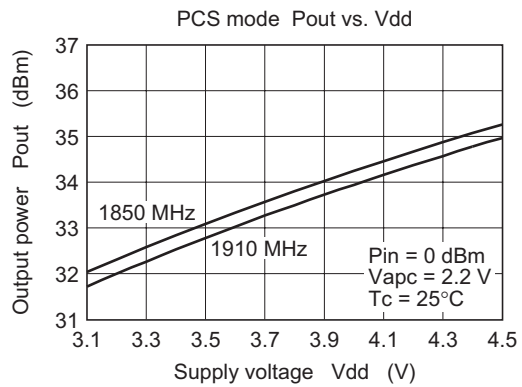
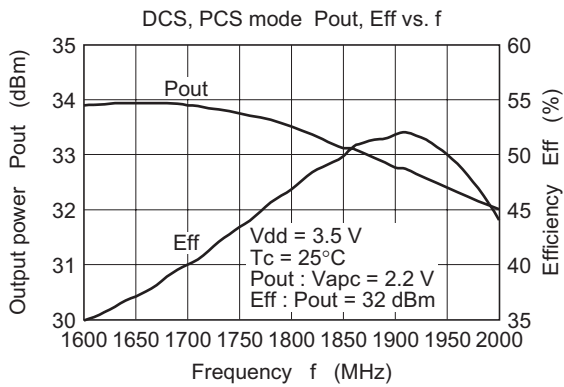
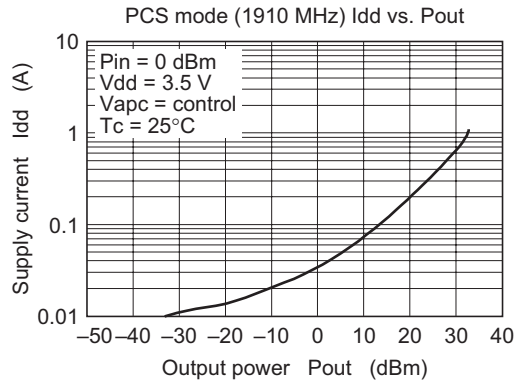
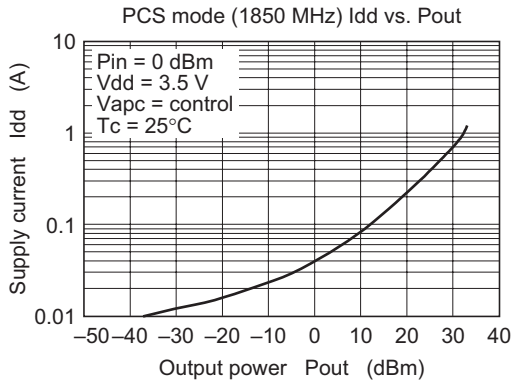

Package Dimensions

Unit: mm

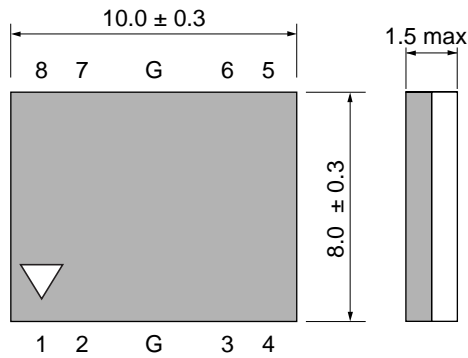

(Upper side)

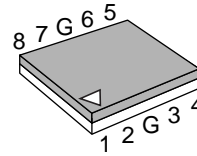
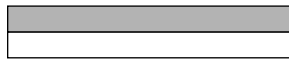

- 1: Pin GSM
- 2: Vapc
- 3: Vdd1
- 4: Pout GSM
- 5: Pout DCS & Pout PCS
- 6: Vdd2
- 7: Vctl
- 8: Pin DCS & Pin PCS
- G: GND

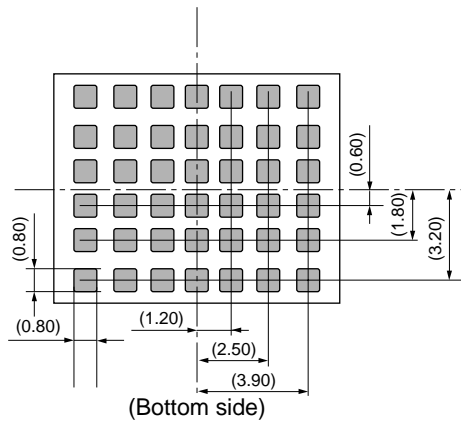

(Bottom side)

Package Code	RF-Q-8
JEDEC	—
JEITA	—
Mass (reference value)	—

**Renesas Technology Corp.** Sales Strategic Planning Div. Nippon Bldg., 2-6-2, Ohte-machi, Chiyoda-ku, Tokyo 100-0004, Japan

---

Keep safety first in your circuit designs!

1. Renesas Technology Corp. puts the maximum effort into making semiconductor products better and more reliable, but there is always the possibility that trouble may occur with them. Trouble with semiconductors may lead to personal injury, fire or property damage.  
Remember to give due consideration to safety when making your circuit designs, with appropriate measures such as (i) placement of substitutive, auxiliary circuits, (ii) use of nonflammable material or (iii) prevention against any malfunction or mishap.

Notes regarding these materials

1. These materials are intended as a reference to assist our customers in the selection of the Renesas Technology Corp. product best suited to the customer's application; they do not convey any license under any intellectual property rights, or any other rights, belonging to Renesas Technology Corp. or a third party.
  2. Renesas Technology Corp. assumes no responsibility for any damage, or infringement of any third-party's rights, originating in the use of any product data, diagrams, charts, programs, algorithms, or circuit application examples contained in these materials.
  3. All information contained in these materials, including product data, diagrams, charts, programs and algorithms represents information on products at the time of publication of these materials, and are subject to change by Renesas Technology Corp. without notice due to product improvements or other reasons. It is therefore recommended that customers contact Renesas Technology Corp. or an authorized Renesas Technology Corp. product distributor for the latest product information before purchasing a product listed herein.  
The information described here may contain technical inaccuracies or typographical errors.  
Renesas Technology Corp. assumes no responsibility for any damage, liability, or other loss rising from these inaccuracies or errors.  
Please also pay attention to information published by Renesas Technology Corp. by various means, including the Renesas Technology Corp. Semiconductor home page (<http://www.renesas.com>).
  4. When using any or all of the information contained in these materials, including product data, diagrams, charts, programs, and algorithms, please be sure to evaluate all information as a total system before making a final decision on the applicability of the information and products. Renesas Technology Corp. assumes no responsibility for any damage, liability or other loss resulting from the information contained herein.
  5. Renesas Technology Corp. semiconductors are not designed or manufactured for use in a device or system that is used under circumstances in which human life is potentially at stake. Please contact Renesas Technology Corp. or an authorized Renesas Technology Corp. product distributor when considering the use of a product contained herein for any specific purposes, such as apparatus or systems for transportation, vehicular, medical, aerospace, nuclear, or undersea repeater use.
  6. The prior written approval of Renesas Technology Corp. is necessary to reprint or reproduce in whole or in part these materials.
  7. If these products or technologies are subject to the Japanese export control restrictions, they must be exported under a license from the Japanese government and cannot be imported into a country other than the approved destination.  
Any diversion or reexport contrary to the export control laws and regulations of Japan and/or the country of destination is prohibited.
  8. Please contact Renesas Technology Corp. for further details on these materials or the products contained therein.
- 



**RENESAS SALES OFFICES**

<http://www.renesas.com>

**Renesas Technology America, Inc.**

450 Holger Way, San Jose, CA 95134-1368, U.S.A  
Tel: <1> (408) 382-7500 Fax: <1> (408) 382-7501

**Renesas Technology Europe Limited.**

Dukes Meadow, Millboard Road, Bourne End, Buckinghamshire, SL8 5FH, United Kingdom  
Tel: <44> (1628) 585 100, Fax: <44> (1628) 585 900

**Renesas Technology Europe GmbH**

Dornacher Str. 3, D-85622 Feldkirchen, Germany  
Tel: <49> (89) 380 70 0, Fax: <49> (89) 929 30 11

**Renesas Technology Hong Kong Ltd.**

7/F., North Tower, World Finance Centre, Harbour City, Canton Road, Hong Kong  
Tel: <852> 2265-6688, Fax: <852> 2375-6836

**Renesas Technology Taiwan Co., Ltd.**

FL 10, #99, Fu-Hsing N. Rd., Taipei, Taiwan  
Tel: <886> (2) 2715-2888, Fax: <886> (2) 2713-2999

**Renesas Technology (Shanghai) Co., Ltd.**

26/F., Ruijin Building, No.205 Maoming Road (S), Shanghai 200020, China  
Tel: <86> (21) 6472-1001, Fax: <86> (21) 6415-2952

**Renesas Technology Singapore Pte. Ltd.**

1, Harbour Front Avenue, #06-10, Keppel Bay Tower, Singapore 098632  
Tel: <65> 6213-0200, Fax: <65> 6278-8001

