

# TrenchMOS™ transistor Logic level FET

## PHP80N06LT, PHB80N06LT

### FEATURES

- 'Trench' technology
- Very low on-state resistance
- Fast switching
- Stable off-state characteristics
- High thermal cycling performance
- Low thermal resistance

### SYMBOL

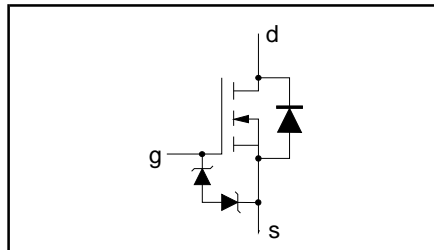

### QUICK REFERENCE DATA

$V_{DSS} = 55 \text{ V}$
$I_D = 75 \text{ A}$
$R_{DS(ON)} \leq 14 \text{ m}\Omega (V_{GS} = 5 \text{ V})$
$R_{DS(ON)} \leq 13 \text{ m}\Omega (V_{GS} = 10 \text{ V})$

### GENERAL DESCRIPTION

N-channel enhancement mode, logic level, field-effect power transistor in a plastic envelope using 'trench' technology. The device has very low on-state resistance. It is intended for use in dc to dc converters and general purpose switching applications.

The PHP80N06LT is supplied in the SOT78 (TO220AB) conventional leaded package.  
The PHB80N06LT is supplied in the SOT404 surface mounting package.

### PINNING

PIN	DESCRIPTION
1	gate
2	drain <sup>1</sup>
3	source
tab	drain

### SOT78 (TO220AB)

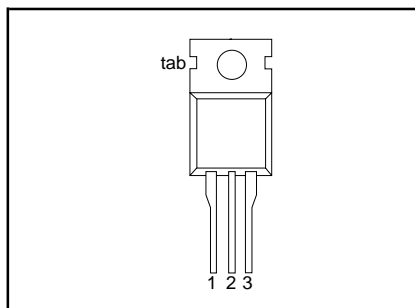

### SOT404

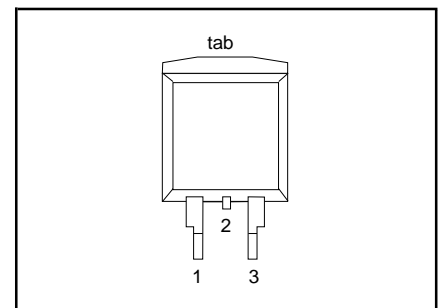

### LIMITING VALUES

Limiting values in accordance with the Absolute Maximum System (IEC 134)

SYMBOL	PARAMETER	CONDITIONS	MIN.	MAX.	UNIT
$V_{DSS}$	Drain-source voltage	$T_j = 25 \text{ }^\circ\text{C}$ to $175 \text{ }^\circ\text{C}$	-	55	V
$V_{DGR}$	Drain-gate voltage	$T_j = 25 \text{ }^\circ\text{C}$ to $175 \text{ }^\circ\text{C}$ ; $R_{GS} = 20 \text{ k}\Omega$	-	55	V
$V_{GS}$	Gate-source voltage		-	$\pm 13$	V
$I_D$	Continuous drain current	$T_{mb} = 25 \text{ }^\circ\text{C}$	-	75	A
		$T_{mb} = 100 \text{ }^\circ\text{C}$	-	56	A
$I_{DM}$	Pulsed drain current	$T_{mb} = 25 \text{ }^\circ\text{C}$	-	240	A
$P_D$	Total power dissipation	$T_{mb} = 25 \text{ }^\circ\text{C}$	-	178	W
$T_j, T_{stg}$	Operating junction and storage temperature		- 55	175	$^\circ\text{C}$

<sup>1</sup> It is not possible to make connection to pin 2 of the SOT404 package.

## TrenchMOS™ transistor Logic level FET

## PHP80N06LT, PHB80N06LT

### THERMAL RESISTANCES

SYMBOL	PARAMETER	CONDITIONS	TYP.	MAX.	UNIT
$R_{th\ j-mb}$	Thermal resistance junction to mounting base		-	0.84	K/W
$R_{th\ j-a}$	Thermal resistance junction to ambient	SOT78 package, in free air SOT404 package, pcb mounted, minimum footprint	60 50	- -	K/W K/W

### ESD LIMITING VALUE

SYMBOL	PARAMETER	CONDITIONS	MIN.	MAX.	UNIT
$V_C$	Electrostatic discharge capacitor voltage, all pins	Human body model (100 pF, 1.5 k $\Omega$ )	-	2	kV

### ELECTRICAL CHARACTERISTICS

$T_j = 25^\circ\text{C}$  unless otherwise specified

SYMBOL	PARAMETER	CONDITIONS	MIN.	TYP.	MAX.	UNIT
$V_{(BR)DSS}$	Drain-source breakdown voltage	$V_{GS} = 0\text{ V}; I_D = 0.25\text{ mA};$ $T_j = -55^\circ\text{C}$	55 50	- -	- -	V V
$V_{(BR)GSS}$	Gate-source breakdown voltage	$I_G = \pm 1\text{ mA};$	10	-	-	V
$V_{GS(TO)}$	Gate threshold voltage	$V_{DS} = V_{GS}; I_D = 1\text{ mA}$ $T_j = 175^\circ\text{C}$ $T_j = -55^\circ\text{C}$	1.0 0.5 -	1.5 - -	2.0 - 2.3	V V V
$R_{DS(ON)}$	Drain-source on-state resistance	$V_{GS} = 5\text{ V}; I_D = 25\text{ A}$ $V_{GS} = 10\text{ V}; I_D = 25\text{ A}$ $T_j = 175^\circ\text{C}$	- - -	12 10 -	14 13 30	m $\Omega$ m $\Omega$ m $\Omega$
$g_{fs}$	Forward transconductance	$V_{DS} = 25\text{ V}; I_D = 25\text{ A}$	30	65	-	S
$I_{GSS}$	Gate source leakage current	$V_{GS} = \pm 5\text{ V}; V_{DS} = 0\text{ V}$ $T_j = 175^\circ\text{C}$	-	0.02	1	$\mu\text{A}$ $\mu\text{A}$
$I_{DSS}$	Zero gate voltage drain current	$V_{DS} = 55\text{ V}; V_{GS} = 0\text{ V};$ $T_j = 175^\circ\text{C}$	-	0.05	10	$\mu\text{A}$ $\mu\text{A}$
$Q_{g(tot)}$	Total gate charge	$I_D = 50\text{ A}; V_{DD} = 44\text{ V}; V_{GS} = 5\text{ V}$	-	43	-	nC
$Q_{gs}$	Gate-source charge		-	13	-	nC
$Q_{gd}$	Gate-drain (Miller) charge		-	20	-	nC
$t_{don}$	Turn-on delay time	$V_{DD} = 30\text{ V}; I_D = 25\text{ A};$	-	35	50	ns
$t_r$	Turn-on rise time	$V_{GS} = 5\text{ V}; R_G = 10\ \Omega$	-	95	145	ns
$t_{doff}$	Turn-off delay time	Resistive load	-	130	180	ns
$t_f$	Turn-off fall time		-	60	80	ns
$L_d$	Internal drain inductance	Measured from tab to centre of die	-	3.5	-	nH
$L_d$	Internal drain inductance	Measured from drain lead to centre of die (SOT78 package only)	-	4.5	-	nH
$L_s$	Internal source inductance	Measured from source lead to source bond pad	-	7.5	-	nH
$C_{iss}$	Input capacitance	$V_{GS} = 0\text{ V}; V_{DS} = 25\text{ V}; f = 1\text{ MHz}$	-	2900	3800	pF
$C_{oss}$	Output capacitance		-	500	600	pF
$C_{rss}$	Feedback capacitance		-	240	330	pF

TrenchMOS™ transistor  
Logic level FET

PHP80N06LT, PHB80N06LT

**REVERSE DIODE LIMITING VALUES AND CHARACTERISTICS**

T<sub>j</sub> = 25 °C unless otherwise specified

SYMBOL	PARAMETER	CONDITIONS	MIN.	TYP.	MAX.	UNIT
I <sub>S</sub>	Continuous source current (body diode)		-	-	68	A
I <sub>SM</sub>	Pulsed source current (body diode)		-	-	240	A
V <sub>SD</sub>	Diode forward voltage	I <sub>F</sub> = 25 A; V <sub>GS</sub> = 0 V	-	0.95	1.2	V
		I <sub>F</sub> = 65 A; V <sub>GS</sub> = 0 V	-	1.0	-	V
t <sub>rr</sub>	Reverse recovery time	I <sub>F</sub> = 65 A; -di <sub>F</sub> /dt = 100 A/μs; V <sub>GS</sub> = -10 V; V <sub>R</sub> = 30 V	-	57	-	ns
Q <sub>rr</sub>	Reverse recovery charge		-	0.14	-	μC

**AVALANCHE LIMITING VALUE**

SYMBOL	PARAMETER	CONDITIONS	MIN.	MAX.	UNIT
W <sub>DSS</sub>	Drain-source non-repetitive unclamped inductive turn-off energy	I <sub>D</sub> = 65 A; V <sub>DD</sub> ≤ 25 V; V <sub>GS</sub> = 5 V; R <sub>GS</sub> = 50 Ω; T <sub>mb</sub> = 25 °C	-	200	mJ

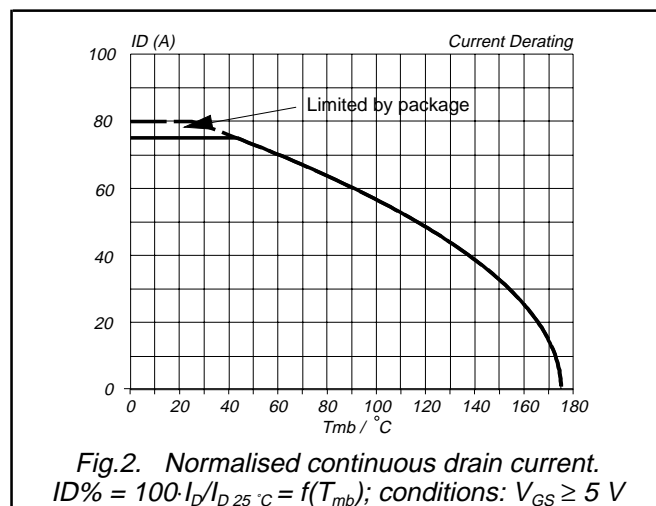
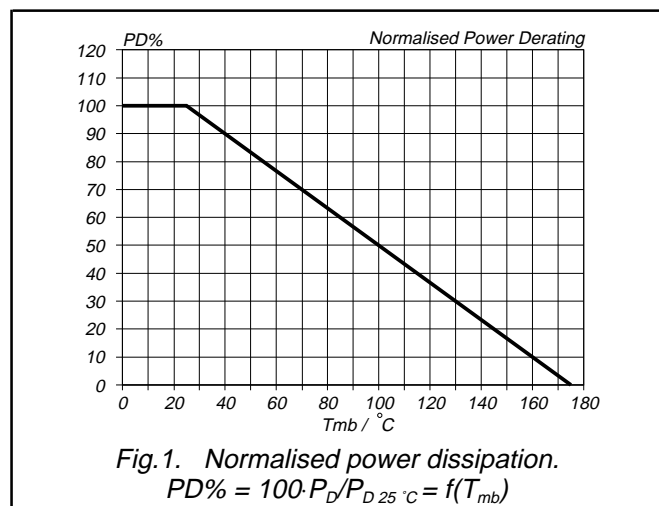

TrenchMOS™ transistor  
Logic level FET

PHP80N06LT, PHB80N06LT

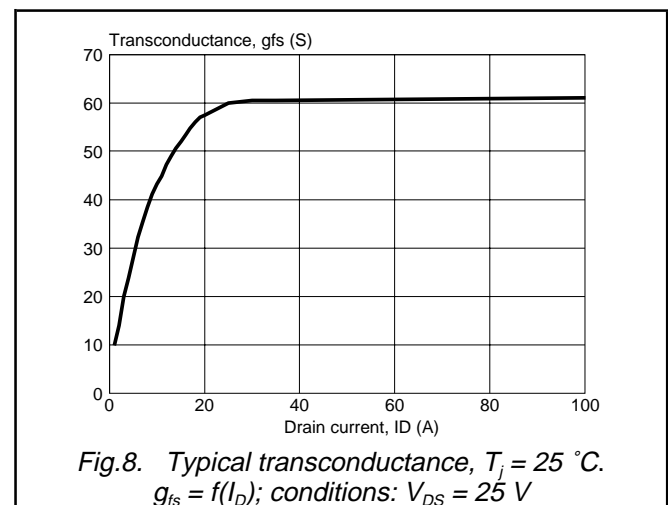
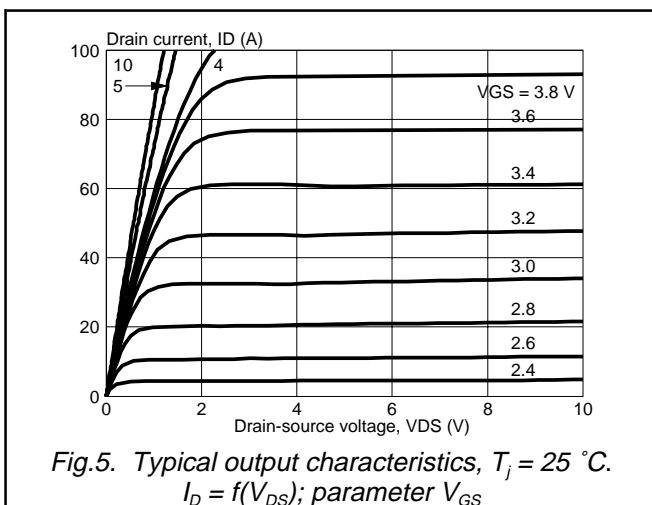
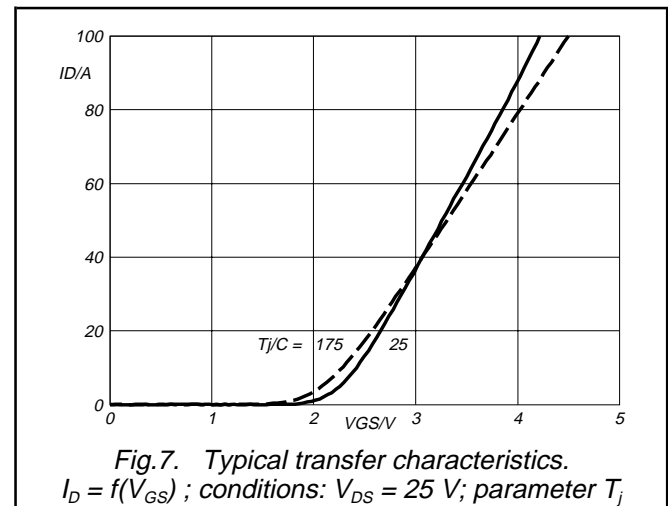
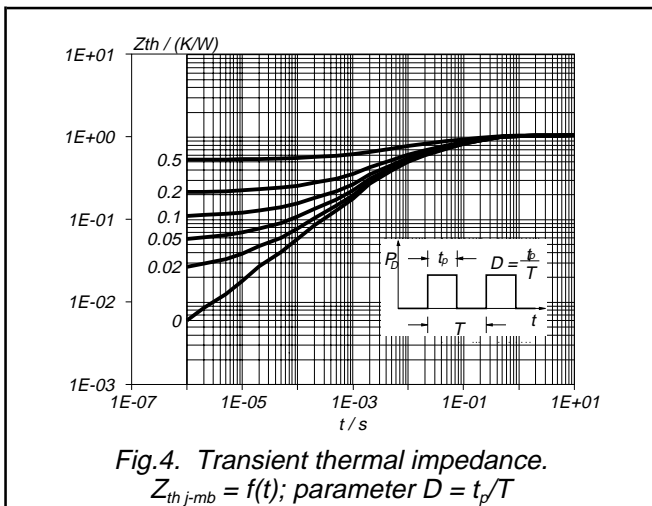
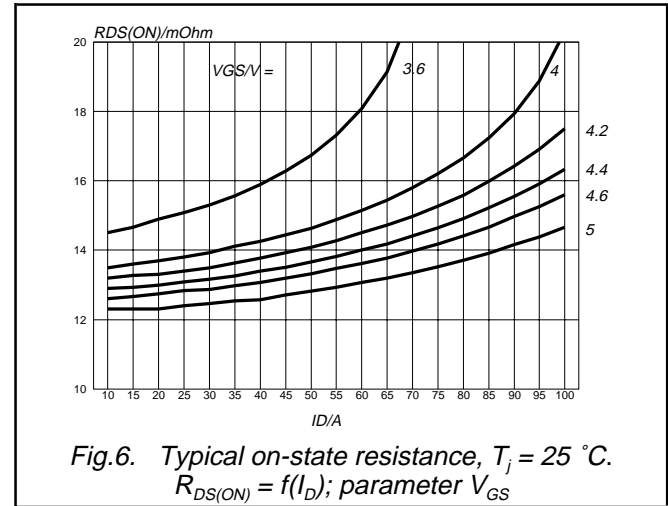
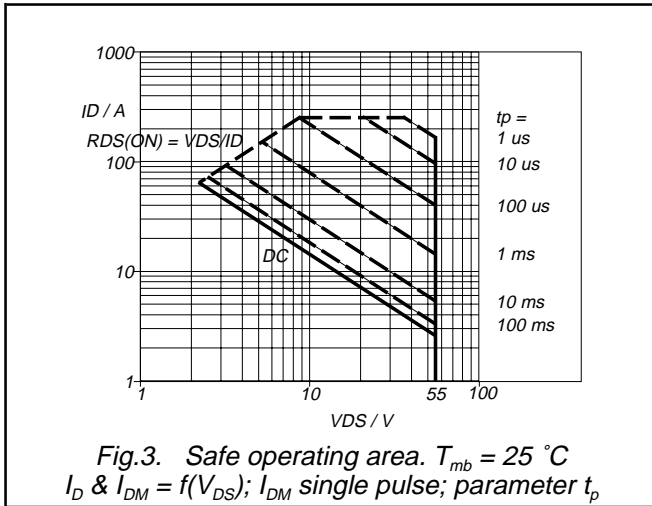

TrenchMOS™ transistor  
Logic level FET

PHP80N06LT, PHB80N06LT

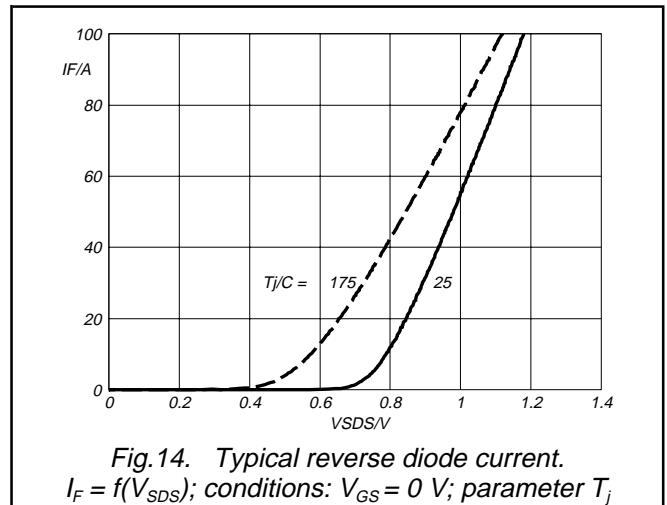
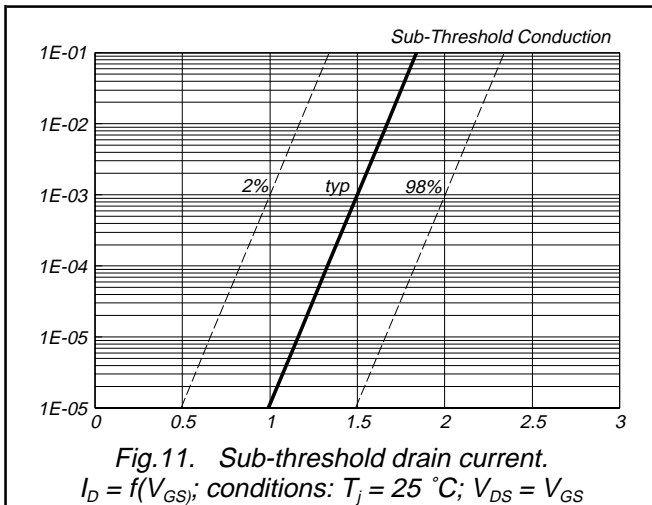
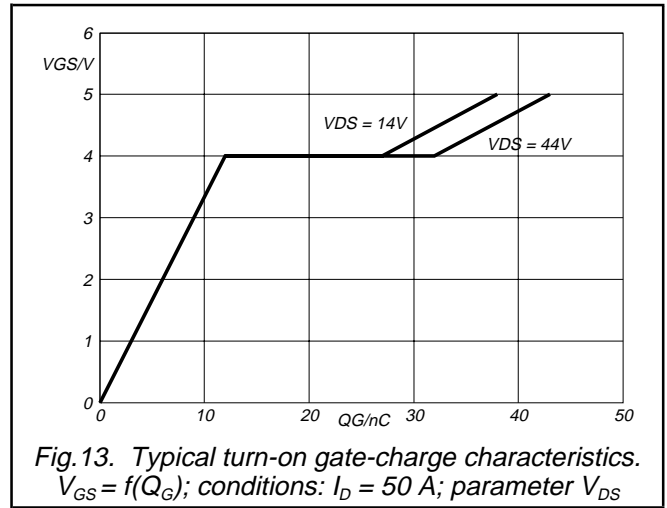
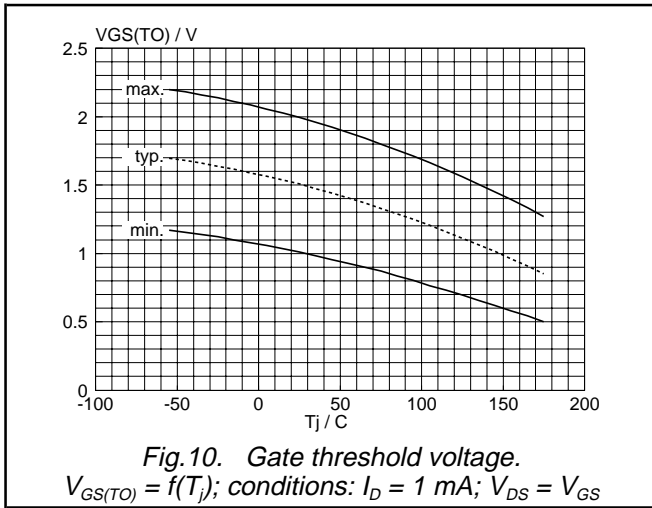
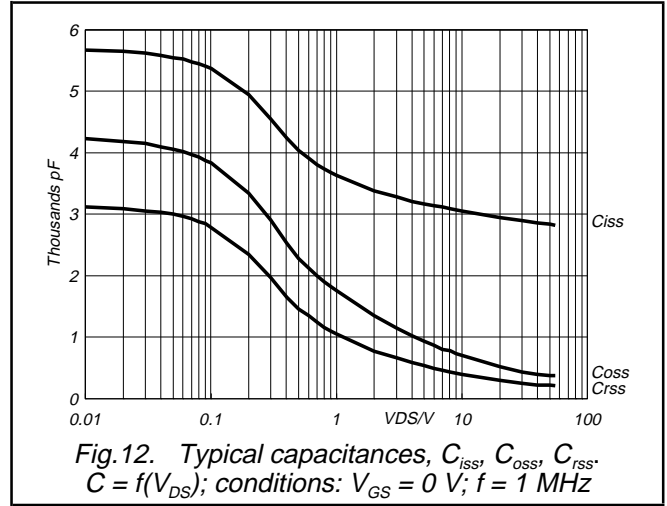
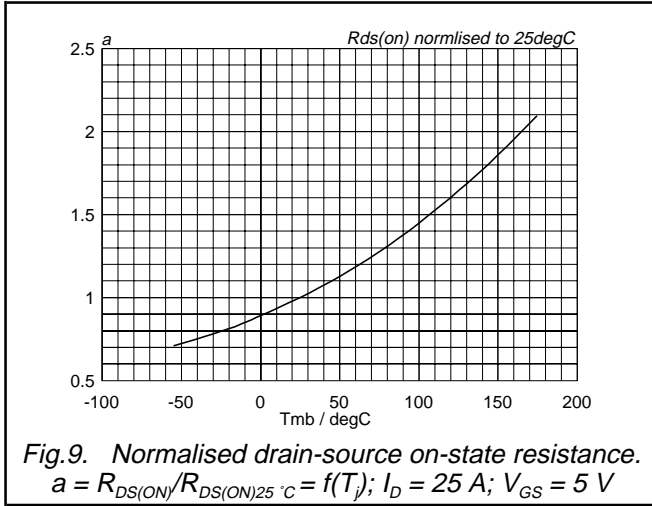

TrenchMOS™ transistor  
Logic level FET

PHP80N06LT, PHB80N06LT

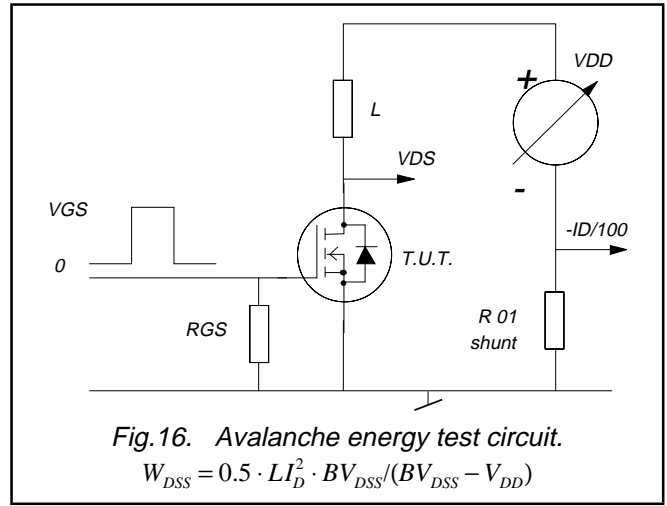
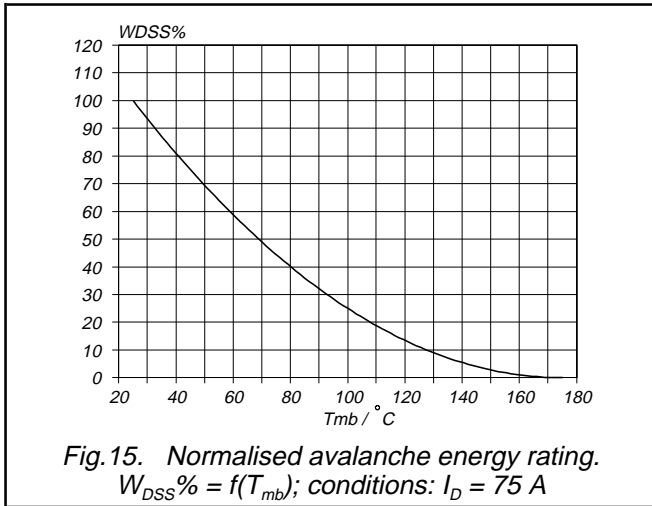

TrenchMOS™ transistor  
Logic level FET

PHP80N06LT, PHB80N06LT

**MECHANICAL DATA**

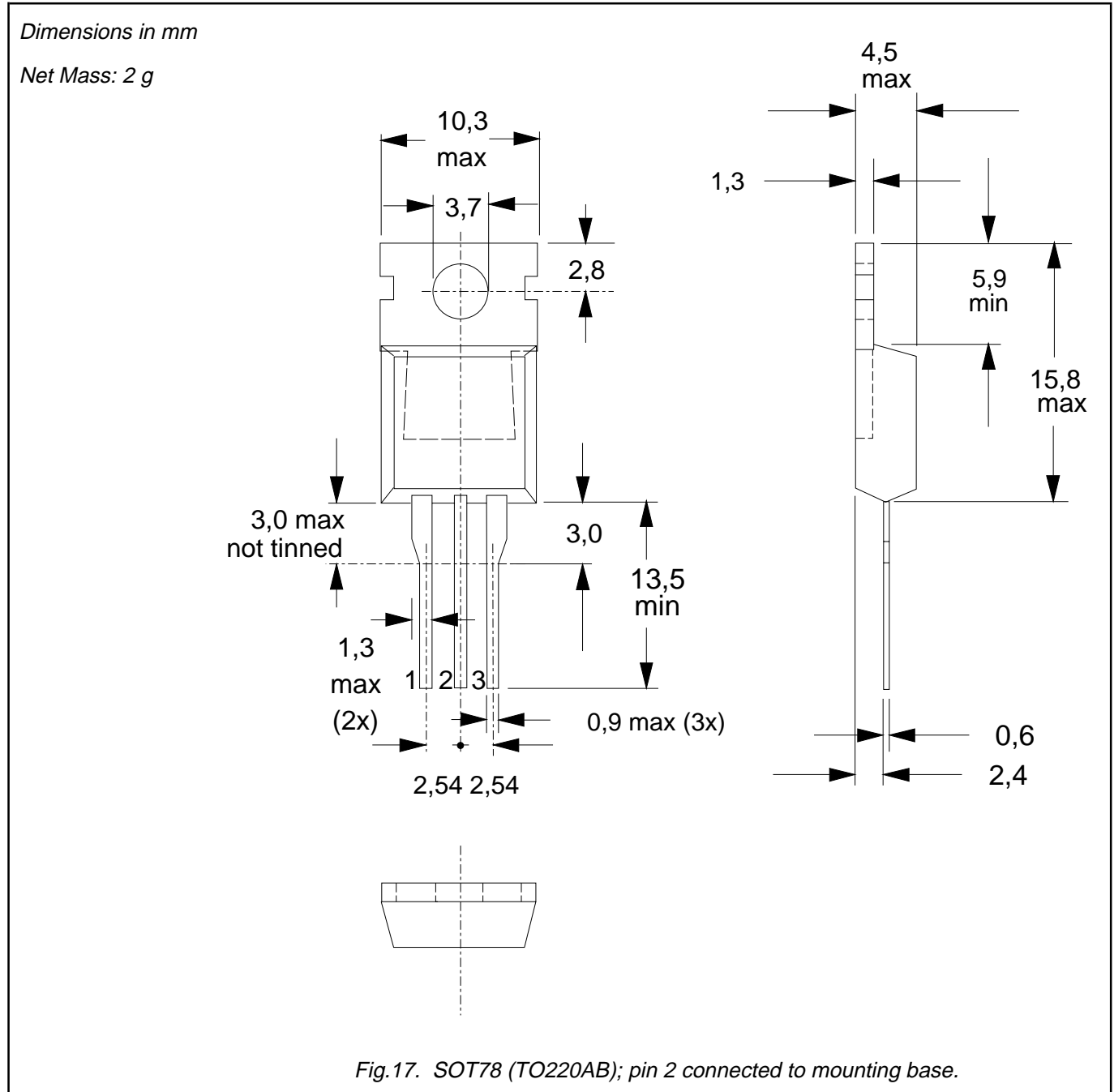

**Notes**

1. Observe the general handling precautions for electrostatic-discharge sensitive devices (ESDs) to prevent damage to MOS gate oxide.
2. Refer to mounting instructions for SOT78 (TO220) envelopes.
3. Epoxy meets UL94 V0 at 1/8".

TrenchMOS™ transistor  
Logic level FET

PHP80N06LT, PHB80N06LT

**MECHANICAL DATA**

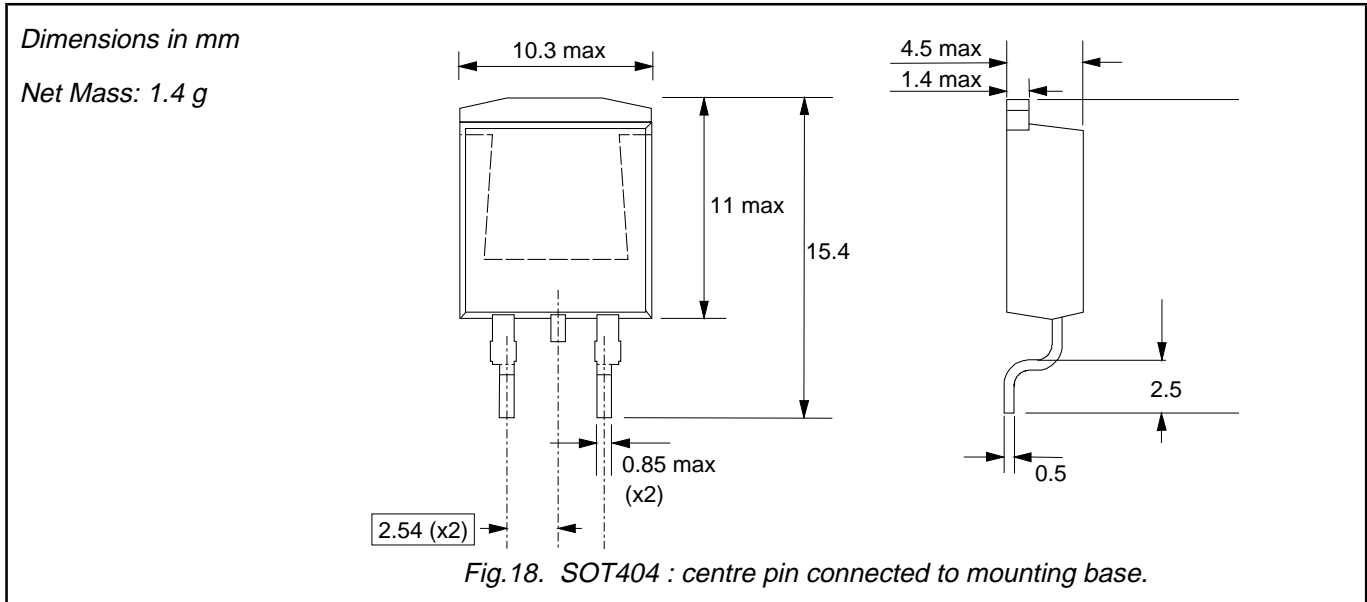

**MOUNTING INSTRUCTIONS**

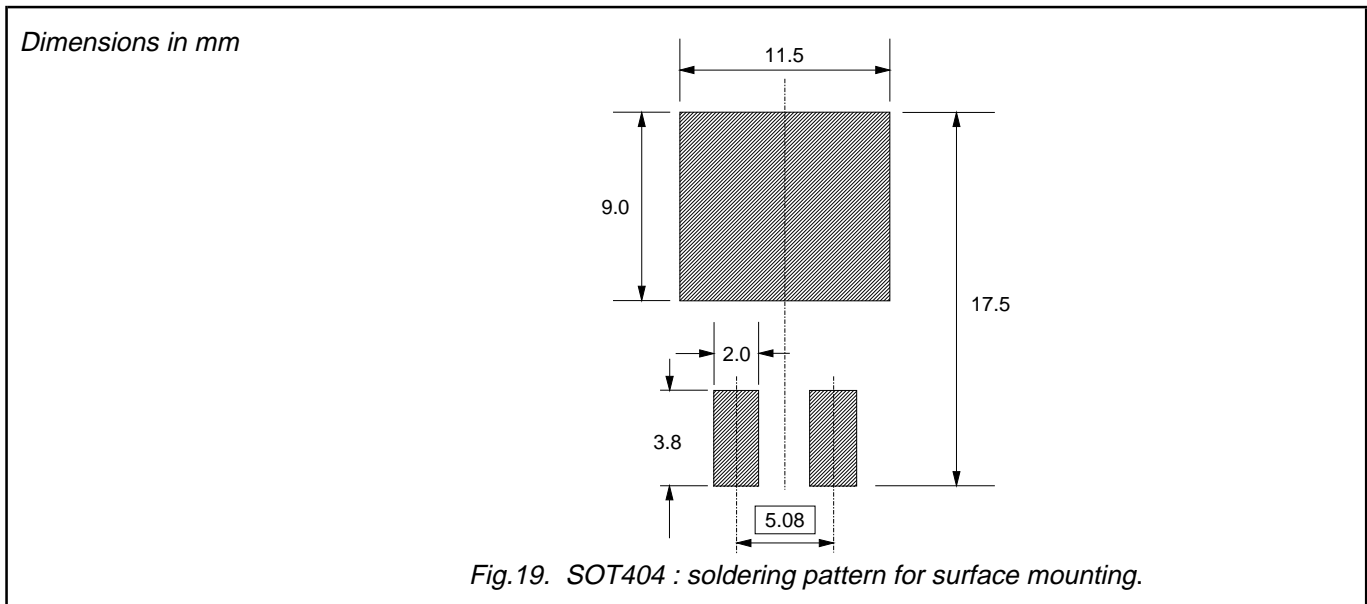

**Notes**

1. Observe the general handling precautions for electrostatic-discharge sensitive devices (ESDs) to prevent damage to MOS gate oxide.
2. Epoxy meets UL94 V0 at 1/8".



---

**TrenchMOS™ transistor**  
**Logic level FET**

---

**PHP80N06LT, PHB80N06LT**

---

**DEFINITIONS**

<b>Data sheet status</b>	
Objective specification	This data sheet contains target or goal specifications for product development.
Preliminary specification	This data sheet contains preliminary data; supplementary data may be published later.
Product specification	This data sheet contains final product specifications.
<b>Limiting values</b>	
Limiting values are given in accordance with the Absolute Maximum Rating System (IEC 134). Stress above one or more of the limiting values may cause permanent damage to the device. These are stress ratings only and operation of the device at these or at any other conditions above those given in the Characteristics sections of this specification is not implied. Exposure to limiting values for extended periods may affect device reliability.	
<b>Application information</b>	
Where application information is given, it is advisory and does not form part of the specification.	
<b>© Philips Electronics N.V. 1998</b>	
All rights are reserved. Reproduction in whole or in part is prohibited without the prior written consent of the copyright owner.	
The information presented in this document does not form part of any quotation or contract, it is believed to be accurate and reliable and may be changed without notice. No liability will be accepted by the publisher for any consequence of its use. Publication thereof does not convey nor imply any license under patent or other industrial or intellectual property rights.	

**LIFE SUPPORT APPLICATIONS**

These products are not designed for use in life support appliances, devices or systems where malfunction of these products can be reasonably expected to result in personal injury. Philips customers using or selling these products for use in such applications do so at their own risk and agree to fully indemnify Philips for any damages resulting from such improper use or sale.