

Part Number: PSA23-11EWA HIGH EFFICIENCY RED

Features

- 2.3 INCH CHARACTER HEIGHT.
- LOW CURRENT OPERATION.
- HIGH CONTRAST AND LIGHT OUTPUT.
- EASY MOUNTING ON P.C. BOARDS OR SOCKETS.
- MECHANICALLY RUGGED.
- STANDARD : GRAY FACE, WHITE SEGMENT.
- RoHS COMPLIANT.

Description

The High Efficiency Red source color devices are made with Gallium Arsenide Phosphide on Gallium Phosphide Orange Light Emitting Diode.

Package Dimensions & Internal Circuit Diagram

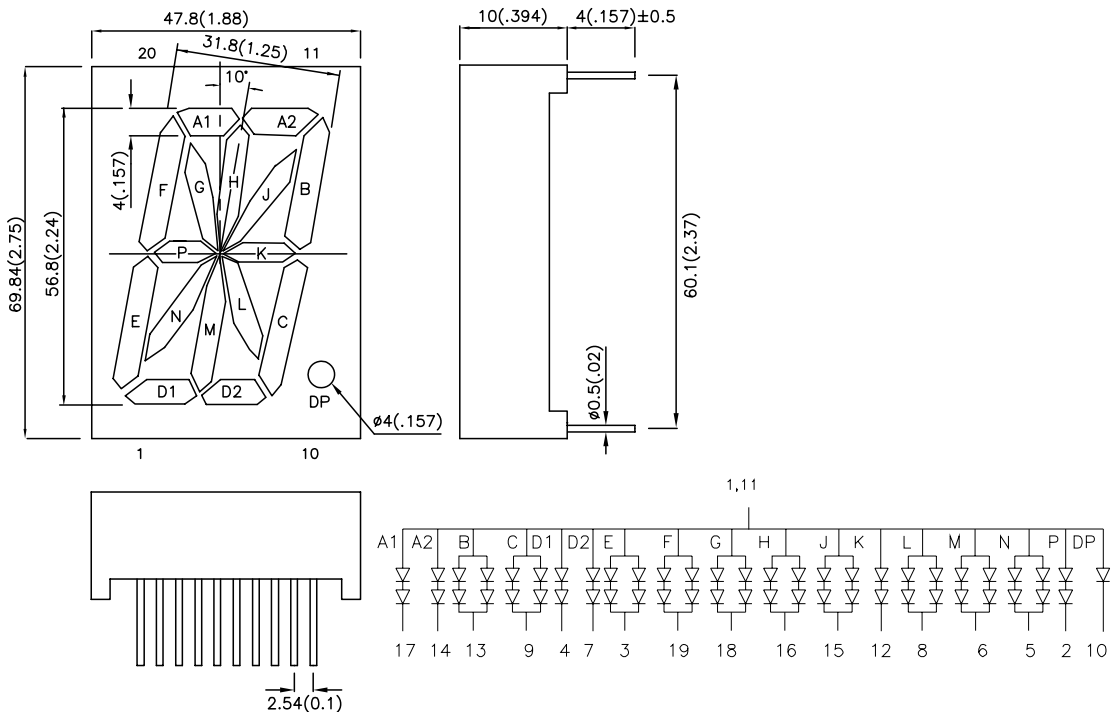

Notes:

1. All dimensions are in millimeters (inches), Tolerance is $\pm 0.25(0.01)$ unless otherwise noted.
2. Specifications are subject to change without notice.

Selection Guide

Part No.	Dice	Lens Type	Iv (ucd) [1] @ 10mA		Description
			Min.	Typ.	
PSA23-11EWA	HIGH EFFICIENCY RED (GaAsP/GaP)	WHITE DIFFUSED	1900	8000	Common Anode, Rt. Hand Decimal.

Note:

1. Luminous Intensity/ Luminous Flux: +/-15%.

Electrical / Optical Characteristics at TA=25°C

Symbol	Parameter		Device	Typ.	Max.	Units	Test Conditions
λ_{peak}	Peak Wavelength		High Efficiency Red	627		nm	IF=20mA
$\lambda_D[1]$	Dominant Wavelength		High Efficiency Red	625		nm	IF=20mA
$\Delta\lambda_{1/2}$	Spectral Line Half-width		High Efficiency Red	45		nm	IF=20mA
C	Capacitance		High Efficiency Red	15		pF	VF=0V;f=1MHz
VF[2]	Forward Voltage	A1,A2,D1,D2,P,K	High Efficiency Red	4.0	5.0	V	IF=20mA
		B,C,E,F,G,H,J,L,M,N		3.8	5.0		
		DP		2.0	2.5		
IR	Reverse Current	A1,A2,D1,D2,P,K	High Efficiency Red		10	uA	VR = 10V VR = 10V VR = 5V
		B,C,E,F,G,H,J,L,M,N			20		
		DP			10		

Notes:

1. Wavelength: +/-1nm.

2. Forward Voltage: +/-0.1V.

Absolute Maximum Ratings at TA=25°C

Parameter		High Efficiency Red	Units
Power dissipation	A1,A2,D1,D2,P,K	150	mW
	B,C,E,F,G,H,J,L,M,N	300	
	DP	105	
DC Forward Current	A1,A2,D1,D2,P,K	30	mA
	B,C,E,F,G,H,J,L,M,N	60	
	DP	30	
Peak Forward Current [1]	A1,A2,D1,D2,P,K	160	mA
	B,C,E,F,G,H,J,L,M,N	320	
	DP	160	
Reverse Voltage	A1,A2,D1,D2,P,K	10	V
	B,C,E,F,G,H,J,L,M,N	10	
	DP	5	
Operating / Storage Temperature		-40°C To +85°C	
Lead Solder Temperature [2]		260°C For 3 Seconds	

Notes:

1. 1/10 Duty Cycle, 0.1ms Pulse Width.

2. 2mm below package base.

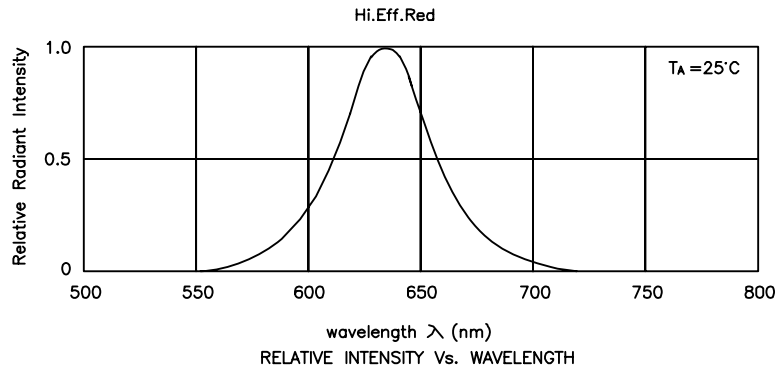

High Efficiency Red

PSA23-11EWA

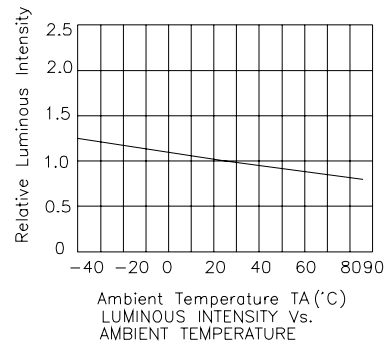
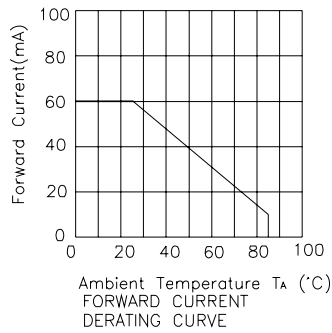
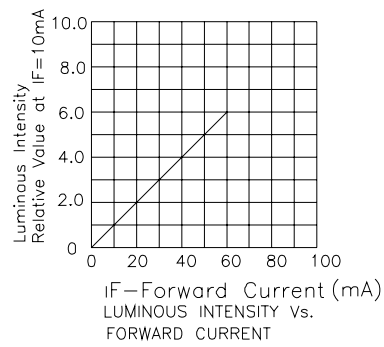
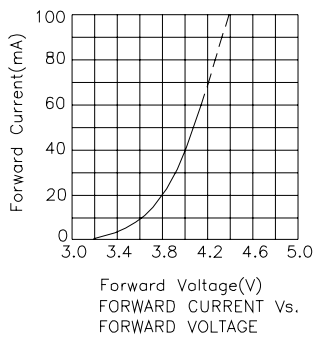

NOTE:the curves are on the segment B,C,E,F,G,H,J,L,M and N.

PACKING & LABEL SPECIFICATIONS

PSA23-11EWA

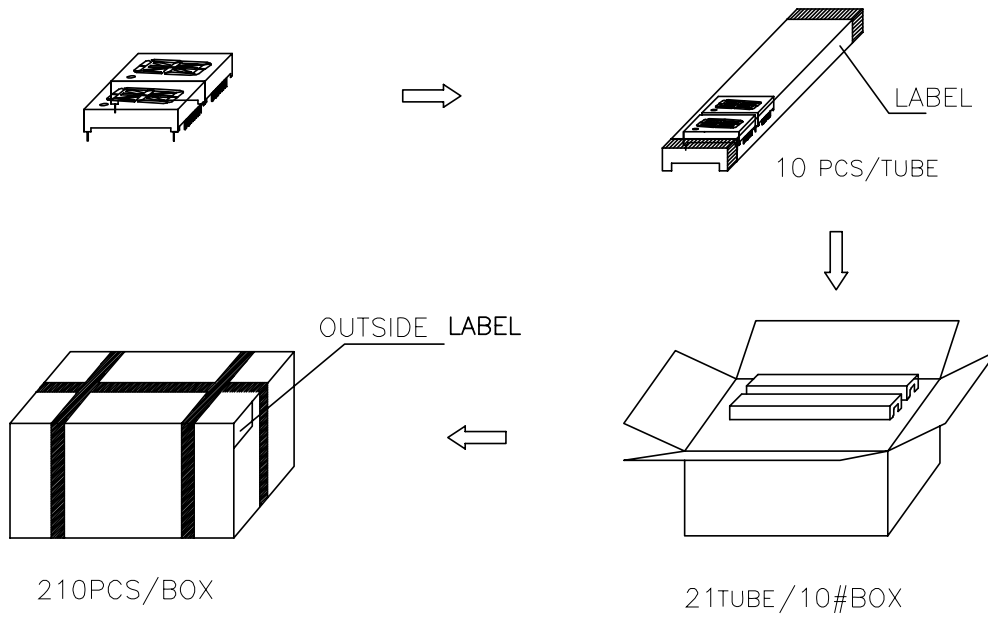

Inside LABEL Paste On The IC-tube

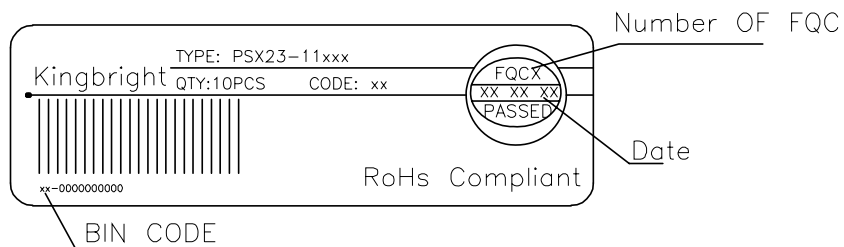

Outside LABEL Paste On The Box

