

## Series PVT412A & PbF

Microelectronic Power IC

HEXFET® Power MOSFET Photovoltaic Relay  
Single Pole, Normally Open,  
0-400V, 240mA AC / 360mA DC

### General Description

The PVT412A Series Photovoltaic Relay is a single-pole, normally open solid-state relay that can replace electromechanical relays in many applications. It utilizes International Rectifier's proprietary HEXFET power MOSFET as the output switch, driven by an integrated circuit photovoltaic generator of novel construction. The output switch is controlled by radiation from a GaAlAs light emitting diode (LED) which is optically isolated from the photovoltaic generator.

These SSRs are specifically designed for industrial control and peripheral telecom applications.

Series PVT412A Relays are packaged in a 6-lead molded DIP package with either thru-hole or surface mount ('gull-wing') terminals. It is available in standard plastic shipping tubes or on tape-and-reel. Please refer to part identification information

### Features

- HEXFET Power MOSFET output
- Bounce-free operation
- 4,000 V<sub>RMS</sub> I/O isolation
- Very low on-resistance (R<sub>DD-ON</sub>)
- Linear AC/DC operation
- Solid-State Reliability
- UL recognized; pending for lead-free part numbers (PbF)
- ESD Tolerance:
  - 4000V Human Body Model
  - 500V Machine Model

### Applications

- Control of AC power line (up to 240 VAC) industrial loads
- Control of DC industrial loads up to +/-300 VDC
- On/Off hook switch
- Dial-pulse generation

### Part Identification

PVT412A & PbF	thru-hole
PVT412AS & PbF	surface-mount
PVT412AS-T & PbF	surface-mount, Tape and Reel

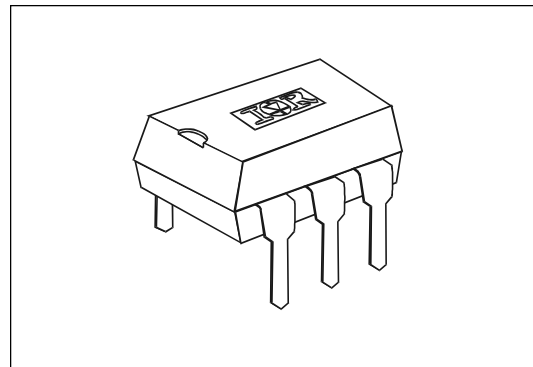

*(HEXFET is the registered trademark for International Rectifier Power MOSFETs)*

**Electrical Specifications** 0-400V, 240ma,AC (T<sub>A</sub> = +25°C) unless otherwise specified)

<b>INPUT CHARACTERISTICS</b>	<b>Limits</b>	<b>Units</b>
Minimum Control Current (see figure 1)	3.0	mA
Maximum Control Current for Off-State Resistance	0.4	mA
Control Current Range (Caution: current limit input LED, see figure 5)	3.0 to 25	mA
Maximum Reverse Voltage	6.0	V

<b>OUTPUT CHARACTERISTICS</b>	<b>Limits</b>	<b>Units</b>
Operating Voltage Range	0 to ±400	V peak
Maximum Load Current @ T <sub>A</sub> =+40°C 5mA Control (see figure 1)		
A Connection	240	mA
B Connection	260	mA
C Connection	360	mA
Maximum On-State Resistance @T <sub>A</sub> =+25°C 100mA Pulsed Load, 5mA Control (see figures 2 & 3)		
A Connection	6	Ω
B Connection	3	Ω
C Connection	2	Ω
Max. pulsed Load Current @T <sub>A</sub> =+25°C, ±400V, 5mA Control (10mS @ 10% duty cycle)	750	mA
Maximum Off-State Leakage @T <sub>A</sub> =+25°C, ±400V	1.0	μA
Maximum Turn-On Time @T <sub>A</sub> =+25°C (see figures 6 & 7) For 50mA, 100 V <sub>DC</sub> load, 5mA Control (5mS pulse width @ 50% duty cycle)	3.0	ms
Maximum Turn-Off Time @T <sub>A</sub> =+25°C (see figures 6 & 7) For 50mA, 100 V <sub>DC</sub> load, 5mA Control (5mS pulse width @ 50% duty cycle)	0.5	ms
Maximum Output Capacitance @ 50V <sub>DC</sub> , f=1MHz (C <sub>out</sub> , see figure 8)	40.0	pF

<b>GENERAL CHARACTERISTICS</b>	<b>Limits</b>	<b>Units</b>
Minimum Dielectric Strength, Input-Output	4000	V <sub>RMS</sub>
Minimum Insulation Resistance, Input-Output	10 <sup>12</sup>	Ω
Maximum Capacitance, Input-Output V <sub>d</sub> =0V, f=1MHz	1.0	pF
Maximum Pin Soldering Temperature (10 seconds maximum)	+260	
Ambient Temperature Range:		°C
	Operating	-40 to +85
	Storage	-40 to +100

International Rectifier does not recommend the use of this product in aerospace, avionics, military or life support applications. Users of this International Rectifier product in such applications assume all risks of such use and indemnify International Rectifier against all damages resulting from such use.

**Connection Diagrams**

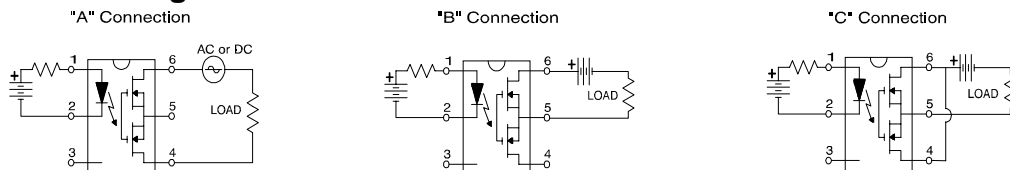

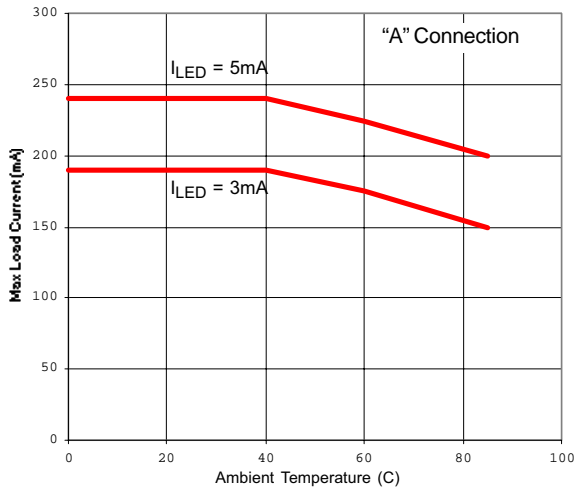

Figure 1. Current Derating Curves

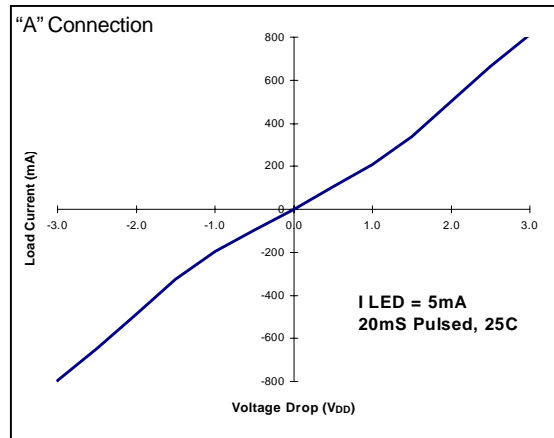

Figure 2. Typical On Characteristics

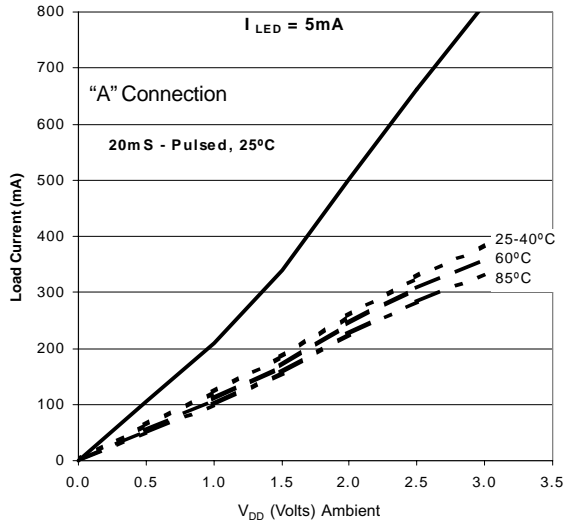

Figure 3. Typical On-Characteristics

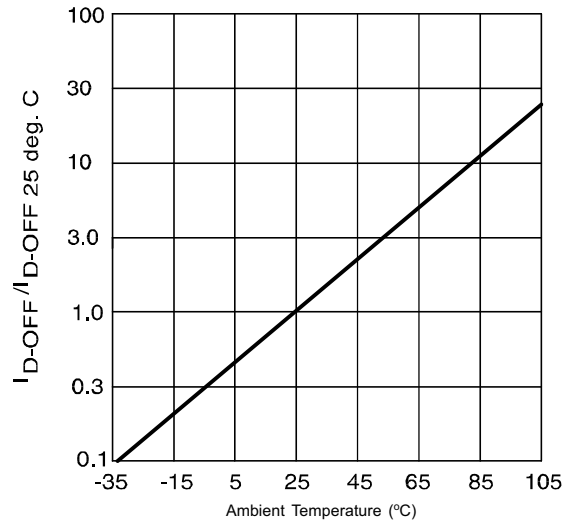
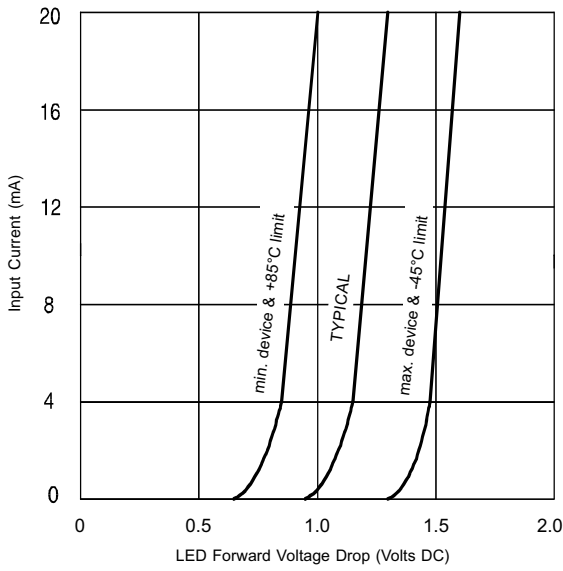
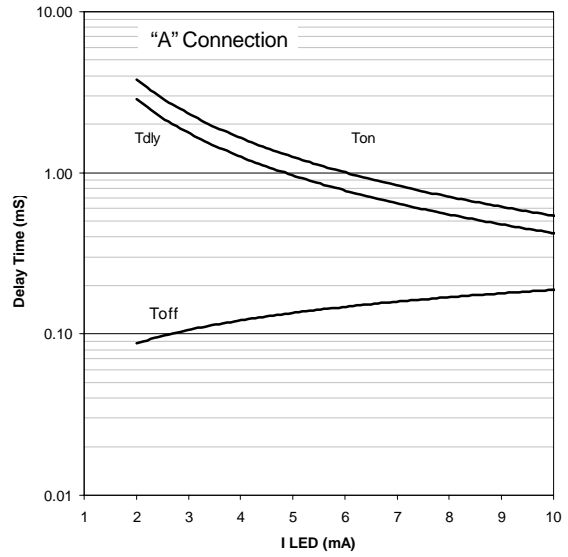

Figure 4. Typical Normalized Off-State Leakage



**Figure 5. Input Characteristics (Current Controlled)**



**Figure 6. Typical Delay Times**

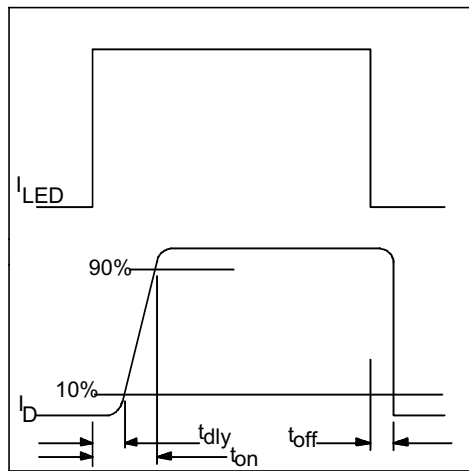

**Figure 7. Delay Time Definitions**

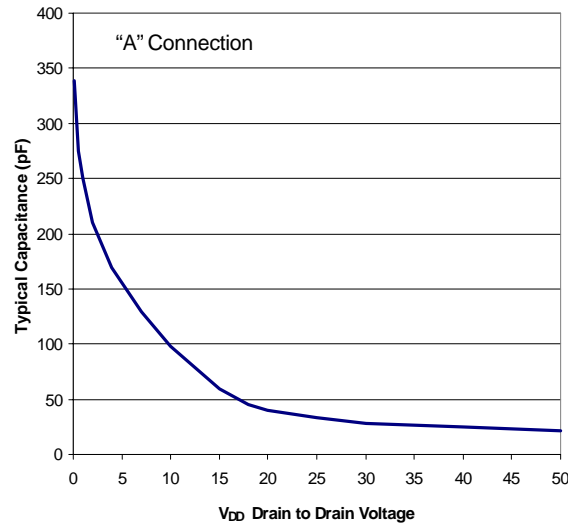

**Figure 8. Typical Output Capacitance**

Case Outlines

