

# TRANSISTOR MODULE (Hi-β)

## QCA150BA60



UL;E76102 (M)

QCA150BA60 is a dual Darlington power transistor module which has series-connected **ULTRA HIGH**  $h_{FE}$ , high speed, high power Darlington transistors. Each transistor has a reverse paralleled fast recovery diode ( $t_{rr}$  : 200ns). The mounting base of the module is electrically isolated from Semiconductor elements for simple heatsink construction.

- $I_C=150A$ ,  $V_{CEX}=600V$
- Low saturation voltage for higher efficiency.
- **ULTRA HIGH** DC current gain  $h_{FE}$ .  $h_{FE} \geq 750$
- Isolated mounting base
- $V_{EBO}$  10V for faster switching speed.

### (Applications)

Motor Control (VWVF), AC/DC Servo, UPS, Switching Power Supply, Ultrasonic Application

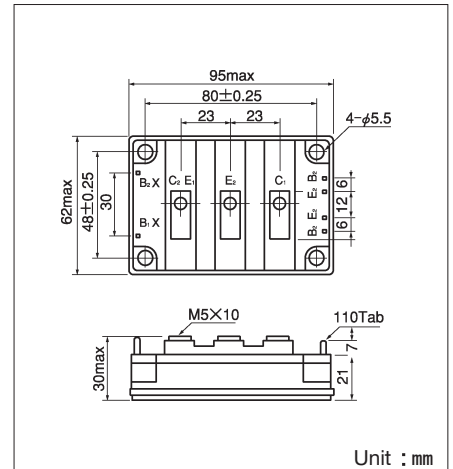
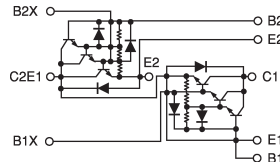

### Maximum Ratings

( $T_j=25^\circ C$ )

Symbol	Item	Conditions	Ratings		
			QCA150BA60	Unit	
$V_{CBO}$	Collector-Base Voltage		600	V	
$V_{CEX}$	Collector-Emitter Voltage	$V_{BE} = -2V$	600	V	
$V_{EBO}$	Emitter-Base Voltage		10	V	
$I_C$	Collector Current	( ) = $pw \leq 1ms$	150 (300)	A	
$-I_C$	Reverse Collector Current		150	A	
$I_B$	Base Current		9	A	
$P_T$	Total power dissipation	$T_C = 25^\circ C$	690	W	
$T_j$	Junction Temperature		-40 ~ +150	$^\circ C$	
$T_{stg}$	Storage Temperature		-40 ~ +125	$^\circ C$	
$V_{ISO}$	Isolation Voltage	A.C.1minute	2500	V	
	Mounting Torque	Mounting (M6)	Recommended Value 1.5~2.5 (15~25)	2.7 (28)	N·m (kgf·cm)
		Terminal (M5)	Recommended Value 1.5~2.5 (15~25)	2.7 (28)	
	Mass	Typical Value	370	g	

### Electrical Characteristics

( $T_j=25^\circ C$ )

Symbol	Item	Conditions	Ratings			Unit
			Min.	Typ.	Max.	
$I_{CBO}$	Collector Cut-off Current	$V_{CB} = V_{CBO}$			2.0	mA
$I_{EBO}$	Emitter Cut-off Current	$V_{EB} = V_{EBO}$			600	mA
$V_{CEO(SUS)}$	Collector Emitter Sustaining Voltage	$I_C = 1A$	450			V
$V_{CEX(SUS)}$		$I_C = 30A, I_{B2} = -5A$	600			
$h_{FE}$	D.C. Current Gain	$I_C = 150A, V_{CE} = 2.5V$	750			
$V_{CE(sat)}$	Collector-Emitter Saturation Voltage	$I_C = 150A, I_B = 200mA$			2.5	V
$V_{BE(sat)}$	Base-Emitter Saturation Voltage	$I_C = 150A, I_B = 200mA$			3.0	V
$t_{on}$	Switching Time	On Time			2.0	$\mu s$
$t_s$		Storage Time	$V_{CC} = 300V, I_C = 150A$		8.0	
$t_f$		Fall Time	$I_{B1} = 300mA, I_{B2} = -3A$		2.0	
$V_{ECO}$	Collector-Emitter Reverse Voltage	$I_C = -150A$			1.8	V
$t_{rr}$	Reverse Recovery time	$V_{CC} = 300V, -I_C = 150A, -di/dt = 150A/\mu s, V_{BE} = -5V$		200		ns
$R_{th(j-c)}$	Thermal Impedance (junction to case)	Transistor part			0.18	$^\circ C/W$
		Diode part			0.6	

### D.C. Current Gain

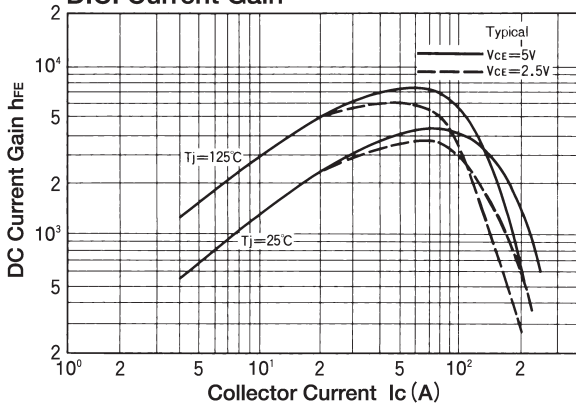

### Collector Current Vs Switching Time

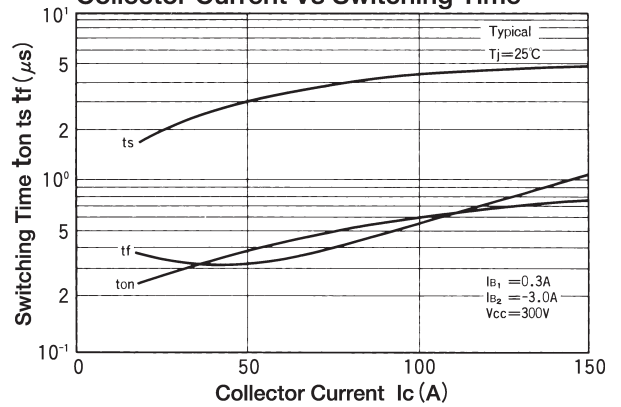

### Forward Bias Safe Operating Area

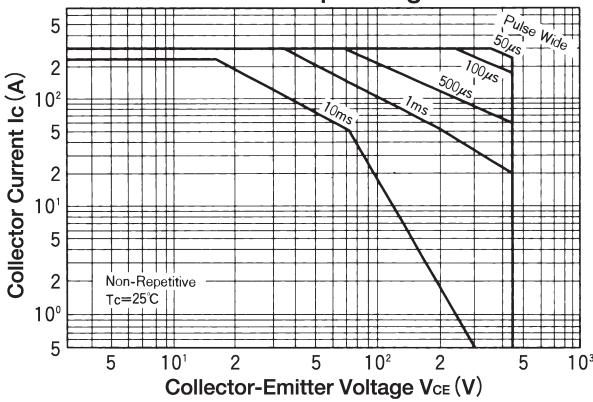

### Reverse Bias Safe Operating Area

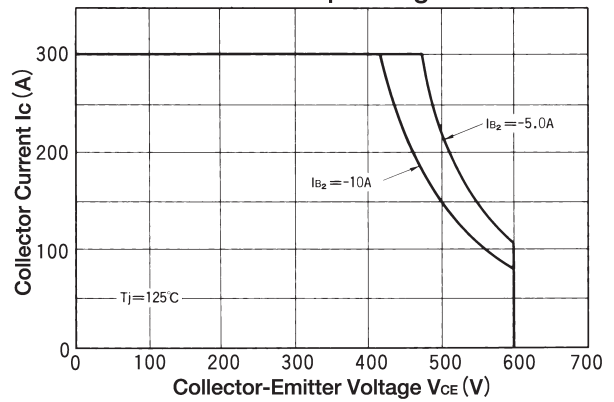

### Collector Current Derating Factor

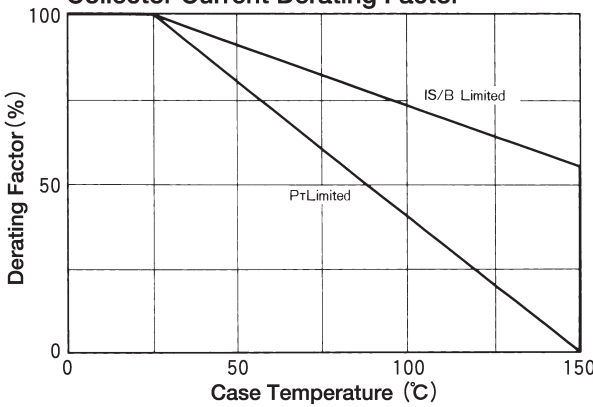

### Forward Voltage of Free Wheeling Diode

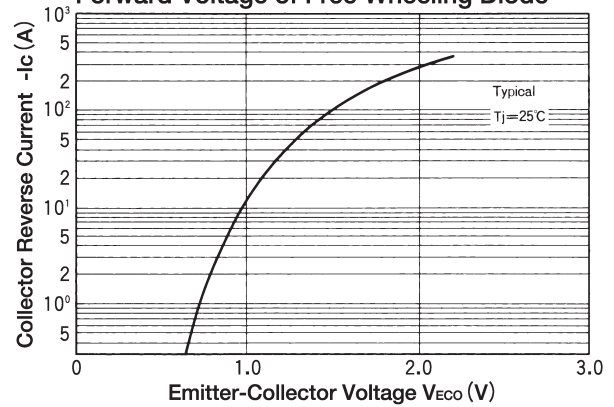

### Reverse Recovery Characteristics

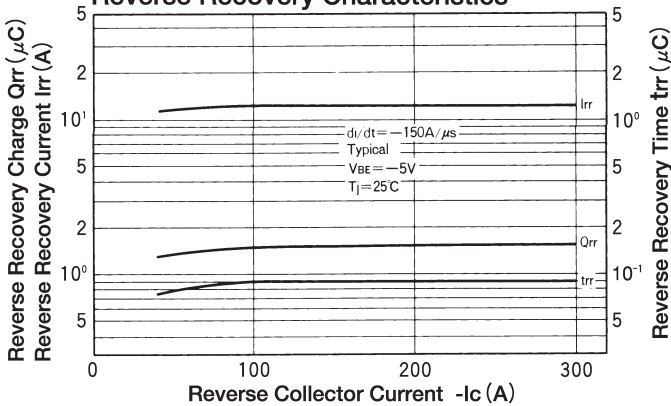

### Maximum Transient Thermal Impedance Characteristics

