

Multianode 16 Channel Linear Array (R5900U-L16: PMT) Multianode 32 Channel Linear Array (H7260: PMT ASSEMBLY)

FEATURES

- High Cathode Sensitivity
Luminous 250 $\mu\text{A}/\text{lm}$ Typ. (-01 Type)
Luminous 500 $\mu\text{A}/\text{lm}$ Typ. (-20 Type)
- Anode Structure
1 mm Channel Pitch
R5900U-L16 Series..... 0.8 mm \times 16 Anodes
H7260 Series..... 0.8 mm \times 32 Anodes
- High Speed Response: Rise Time 0.6 ns Typ.

APPLICATIONS

- Biomedical Fluorescence Detection
- Laser Scanning Detection
- Spectroscopy
- Environmental Monitoring



LEFT: R5900U-L16 SERIES RIGHT: H7260 SERIES

Figure 1: Typical Spectral Response

-00 and -03 Types

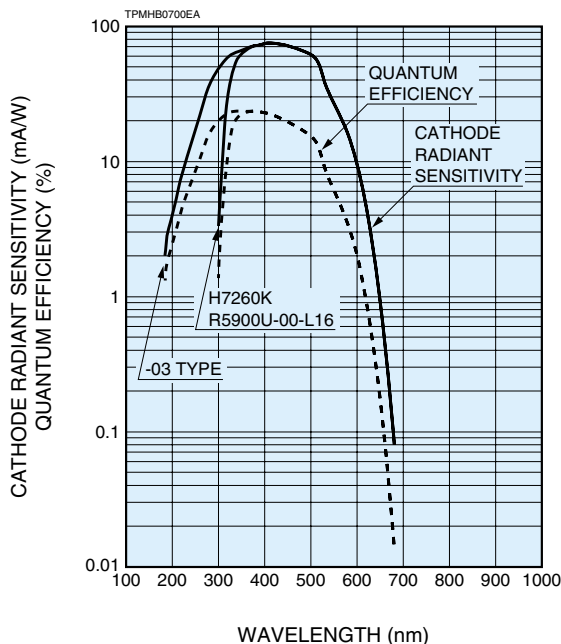

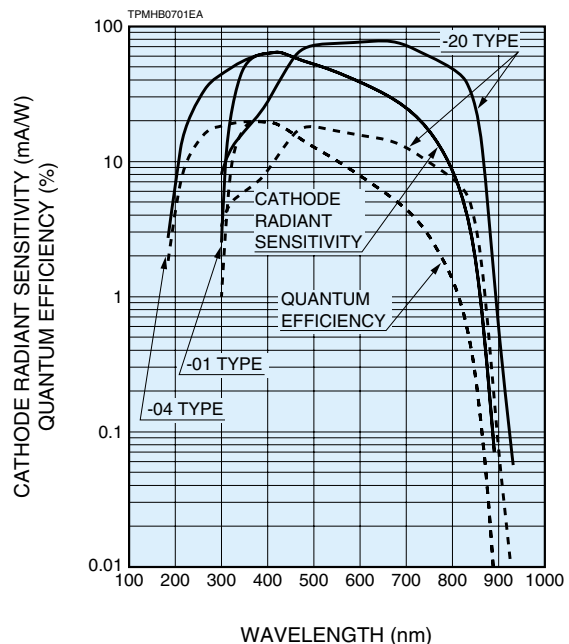

-01, -04 and -20 Types



LINEAR ARRAY MULTIANODE PMT AND ASSEMBLY R5900U-L16 SERIES, H7260 SERIES

SPECIFICATIONS

Type No.	Anode Type		Outline No.	Effective Area per Channel (mm)	Channel Pitch (mm)	Dynode Structure / No. of Stages ^(A)	Weight (g)	Insulation Cover Material ^(B)
R5900U-L16 SERIES	16 Channel Linear Array		1 (See Fig.8)	0.8 × 16	1	MC/10	35	P.O.M.
H7260 SERIES	32 Channel Linear Array		2 (See Fig.13)	0.8 × 7	1	MC/10	62	P.O.M.

Notes:

(A) MC: Metal Channel

(B) P.O.M: polyoxymethylene

Type No.	Spectral Response		Photocathode Material ^(G)	Window Material ^(H)	Cathode Characteristics				Supply Voltage (V dc)	
	Range (nm)	Peak Wavelength (nm)			Luminous		Blue Sens. Index (CS 5-58) Typ.	Red /White Ratio (R-68) Typ.		Radiant ^(I) Typ. (mA/W)
					Min. (μ A/lm)	Typ. (μ A/lm)				
R5900U-00-L16	300 to 650	420	BA	B	50	70	8.5	—	72	-800 (J)
R5900U-01-L16	300 to 880	420	MA	B	150	250	—	0.3	65	-800 (J)
R5900U-03-L16	185 to 650	420	BA	U	50	70	8.5	—	72	-800 (J)
R5900U-04-L16	185 to 880	420	MA	U	150	250	—	0.3	65	-800 (J)
R5900U-20-L16	300 to 920	630	MA	B	350	500	—	0.45	78	-800 (J)
H7260K	300 to 650	420	BA	B	50	70	8.5	—	72	-800
H7260-01	300 to 880	420	MA	B	150	250	—	0.3	65	-800
H7260-03	185 to 650	420	BA	U	50	70	8.5	—	72	-800
H7260-04	185 to 880	420	MA	U	150	250	—	0.3	65	-800
H7260-20	300 to 920	630	MA	B	350	500	—	0.45	78	-800

Notes:

(G) BA: Bialkali MA: Multialkali

(H) B: Borosilicate glass U: UV glass

(I) Measured at the peak wavelength

(at 25 °C)

Socket / Socket Assembly [Ⓒ]	Maximum Ratings [Ⓓ]				Type No.
	Supply Voltage (V dc)	Total Average Anode Current (μA) [Ⓔ]	Average Anode Current per Channel (μA) [Ⓔ]	Voltage Divider Current (mA)	
E678-32B / E6736	-900	100	10	—	R5900U-L16 SERIES
SD-108-T-22* / —	-900	100	6	0.37 [Ⓕ]	H7260 SERIES

Notes:

- Ⓒ *: Supplied No mark: Sold separately
- Ⓓ The maximum ambient temperature range
R5900U-L16 SERIES: -30 °C to +50 °C
R7260 SERIES: 0 °C to +50 °C
- Ⓔ Averaged over any interval of 30 seconds maximum.
- Ⓕ Measured with the maximum supply voltage.

(at 25 °C)

Anode Characteristics [Ⓚ]							Pulse Linearity per Channel (±2 % deviation) (mA)	Cross-talk (%)	Uniformity Between Each Anode		Type No.		
Luminous		Gain Typ.	Dark Current per Channel (After 30 min.)		Time Response				Typ.	Max.		Typ.	Max.
Min. (A/lm)	Typ. (A/lm)		Typ. (nA)	Max. (nA)	Rise Time Typ. (ns)	Transit Time Spread (FWHM) (ns)							
50	280	4 × 10 ⁶	0.2	2	0.6	0.18	0.8	3	1: 1.5	1: 2	R5900U-00-L16		
75	250	1 × 10 ⁶	0.5	5	0.6	0.18	0.8	3	1: 1.7	1: 2.5	R5900U-01-L16		
50	280	4 × 10 ⁶	0.2	2	0.6	0.18	0.8	3	1: 1.5	1: 2	R5900U-03-L16		
75	250	1 × 10 ⁶	0.5	5	0.6	0.18	0.8	3	1: 1.7	1: 2.5	R5900U-04-L16		
175	500	1 × 10 ⁶	1	10	0.6	0.18	0.8	3	1: 1.7	1: 2.5	R5900U-20-L16		
50	140	2 × 10 ⁶	0.2	2	0.6	0.18	0.6	3	1: 1.5	1: 2	H7260K		
75	250	1 × 10 ⁶	0.5	5	0.6	0.18	0.6	3	1: 1.7	1: 2.5	H7260-01		
50	140	2 × 10 ⁶	0.2	2	0.6	0.18	0.6	3	1: 1.5	1: 2	H7260-03		
75	250	1 × 10 ⁶	0.5	5	0.6	0.18	0.6	3	1: 1.7	1: 2.5	H7260-04		
175	500	1 × 10 ⁶	1	10	0.6	0.18	0.6	3	1: 1.7	1: 2.5	H7260-20		

Notes:

- Ⓛ Refer to the "voltage distribution ratio and voltage" shown below

Electrodes	K	Dy1	Dy2	...	Dy10	P
Distribution	1	1	1	...	1	

Supply Voltage: 800 V, K: Cathode, Dy: Dynode, P: Anode

- Ⓚ Anode characteristics are measured with the supply voltage and voltage distribution ratio specified by note Ⓛ

LINEAR ARRAY MULTIANODE PMT AND ASSEMBLY R5900U-L16 SERIES, H7260 SERIES

R5900U-L16 SERIES

Figure 2: Cross-Section

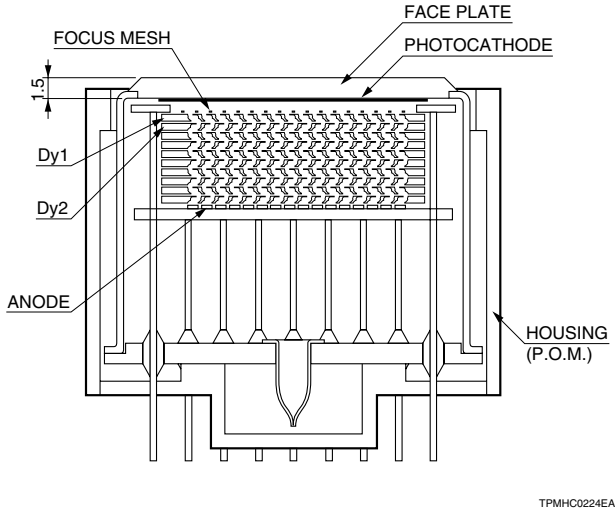

Figure 3: Typical Gain Characteristics

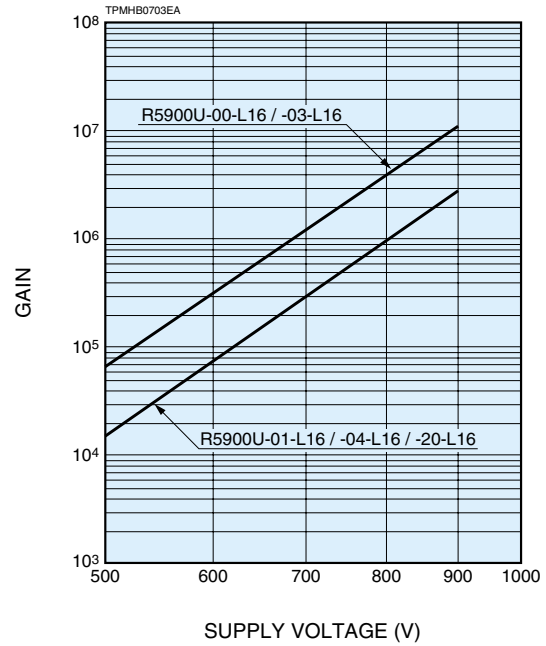

Figure 4: Anode Uniformity (Example)

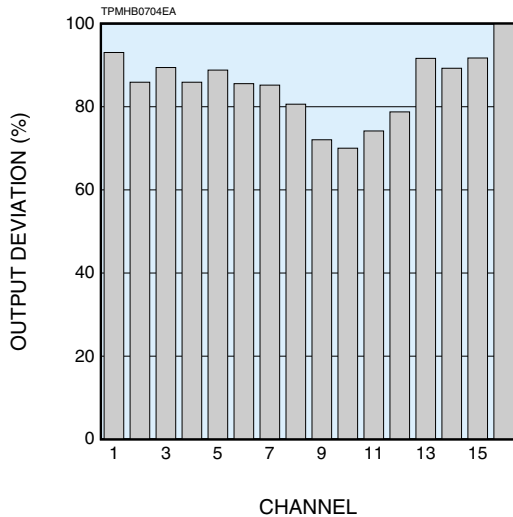

Figure 5: Cross-Talk (Example)

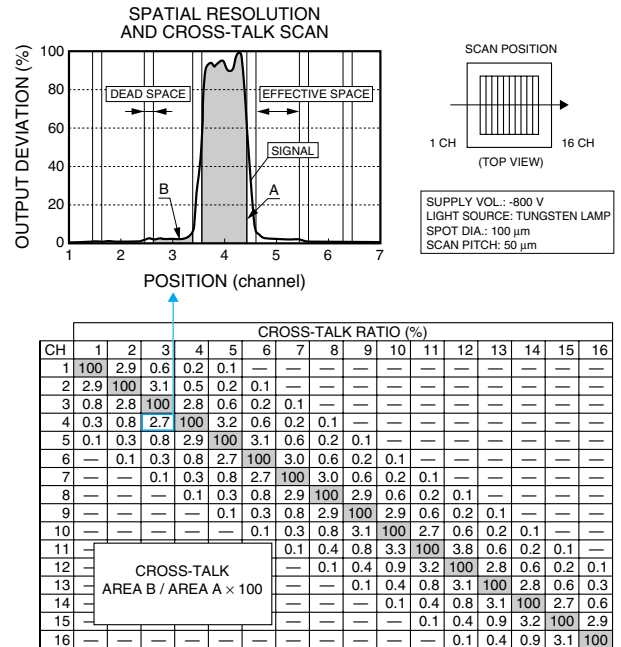
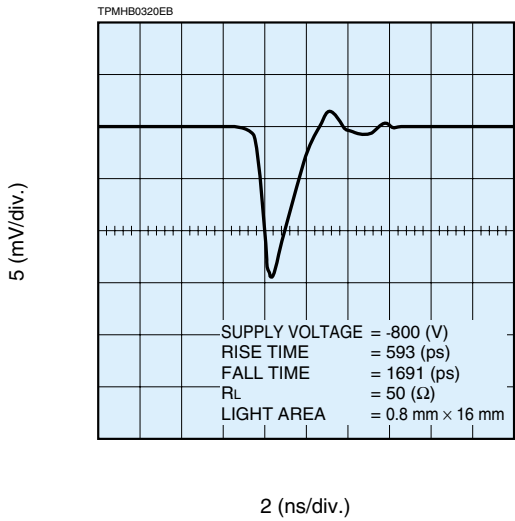
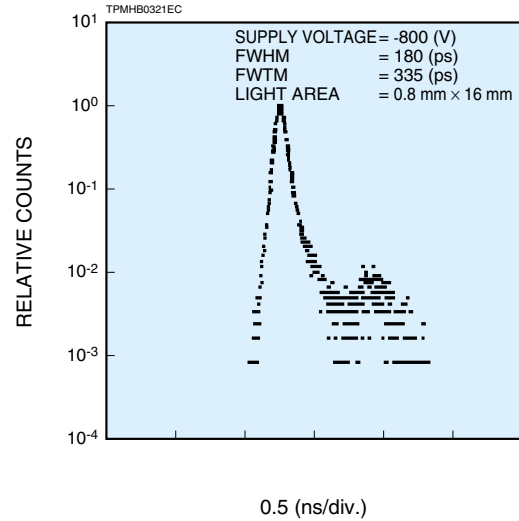

Figure 6: Typical Time Response



Light is irradiated to only one channel at this measurement.

Figure 7: Typical Transit Time Spread Characteristics



Light is irradiated to only one channel at this measurement.

Figure 8: Dimensional Outline and Basing Diagram (Unit: mm)

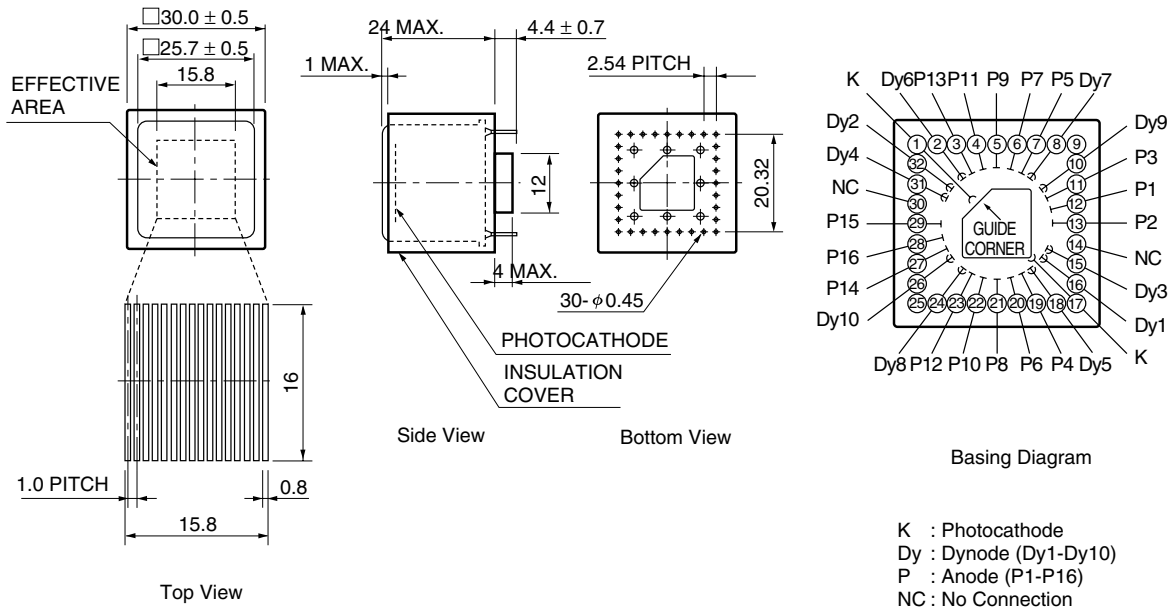

LINEAR ARRAY MULTIANODE PMT AND ASSEMBLY R5900U-L16 SERIES, H7260 SERIES

H7260 SERIES

Figure 9: Cross-Section

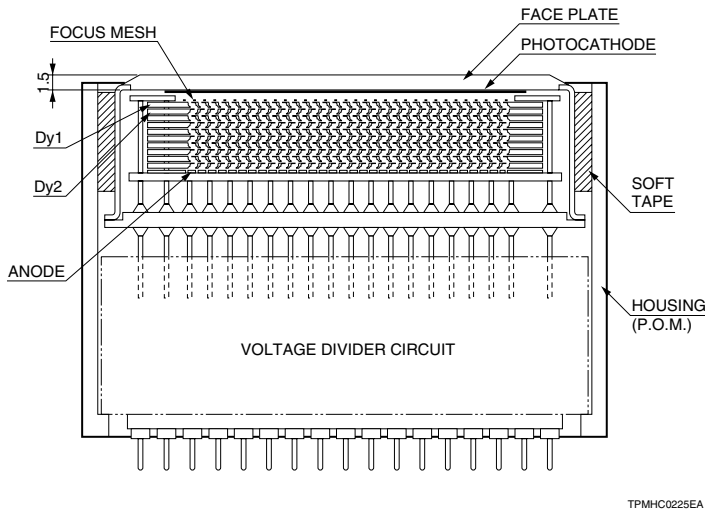

Figure 10: Typical Gain Characteristics

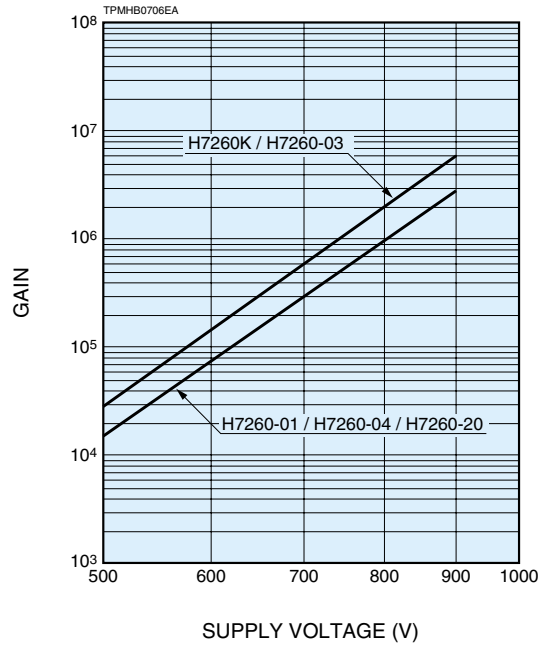

Figure 11: Anode Uniformity (Example)

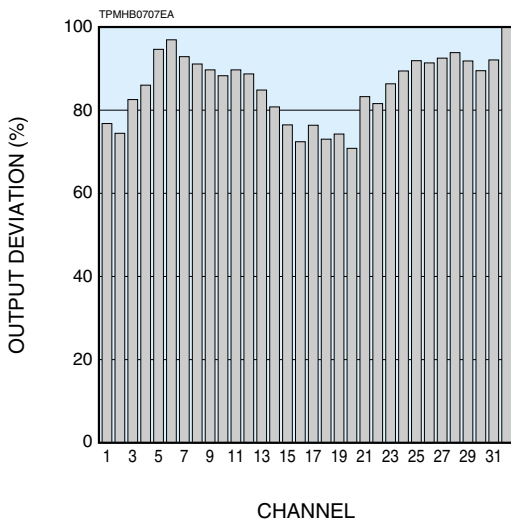

Figure 12: Socket

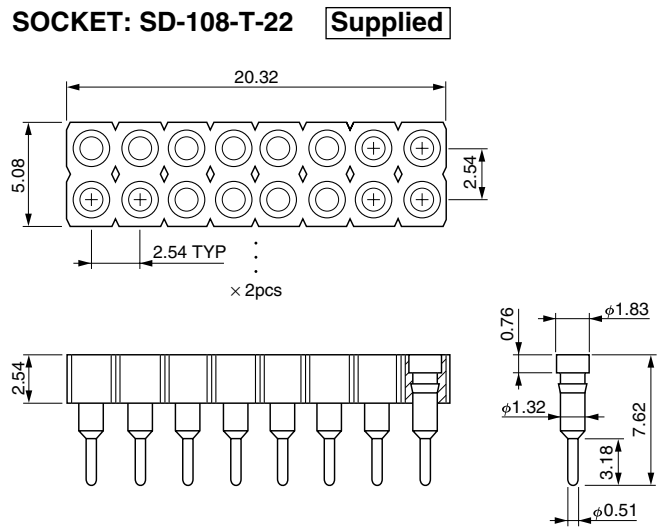
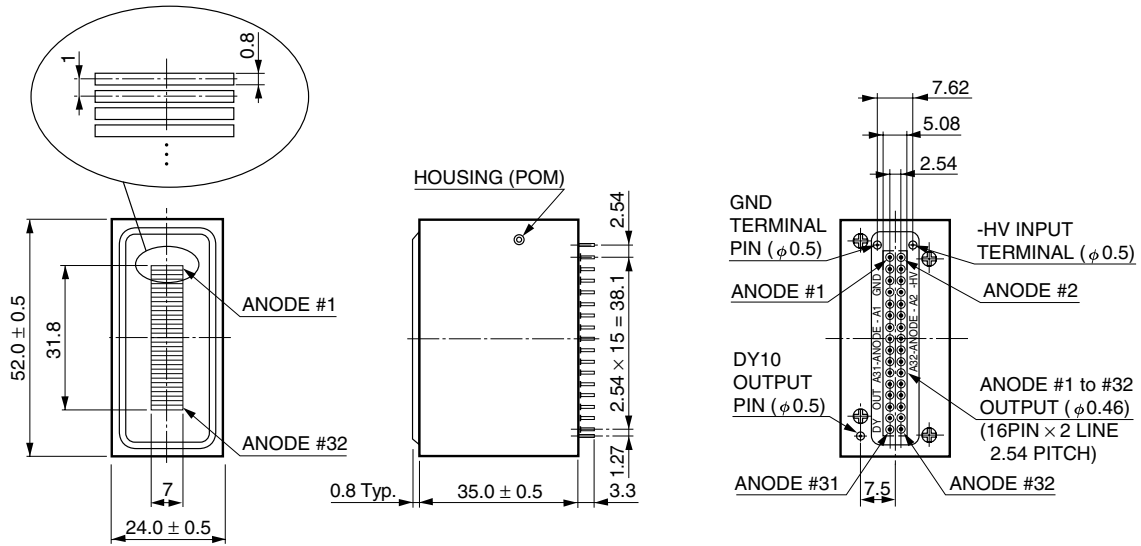
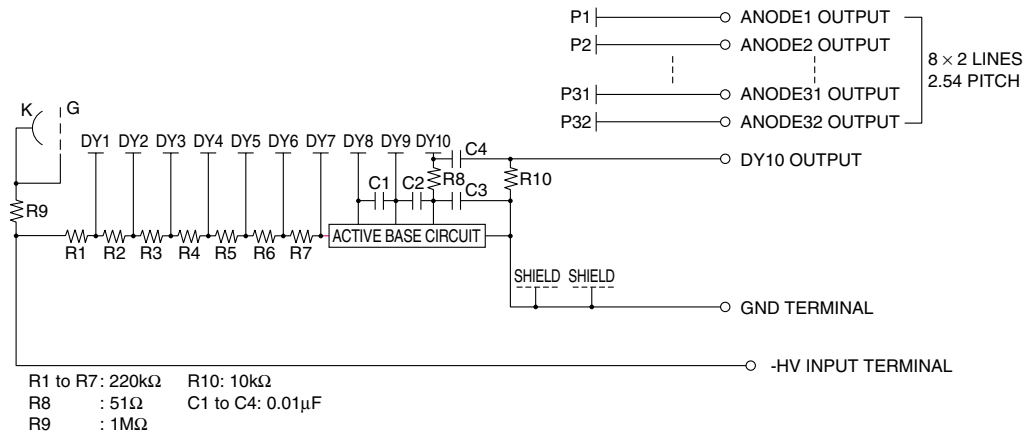

Figure 13: Dimensional Outline and Circuit Diagram of H7260 (Unit: mm)



TPMHA0455EC



TPMHC0192EA

H7260A -HV input cable type is available

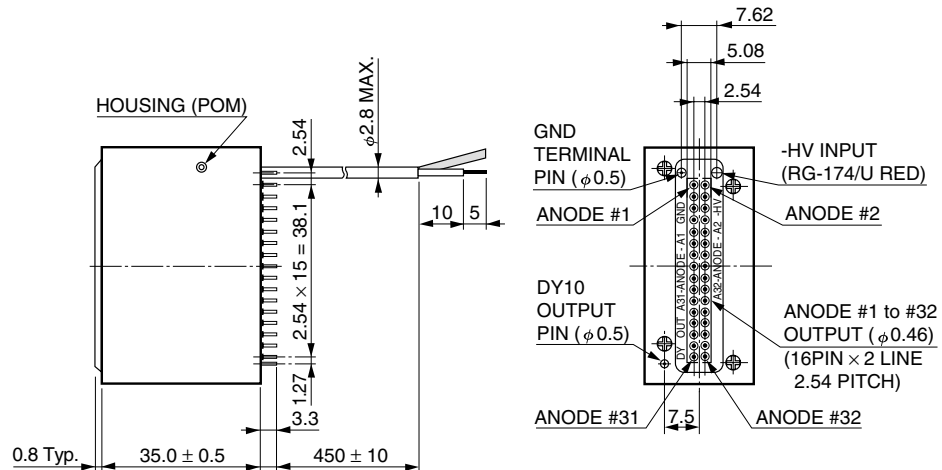

TPMHA0456EC

LINEAR ARRAY MULTIANODE PMT AND ASSEMBLY R5900U-L16 SERIES, H7260 SERIES

[ACCESSORIES FOR R5900U-L16 SERIES]

● Socket E678-32B **SOLD SEPARATELY**

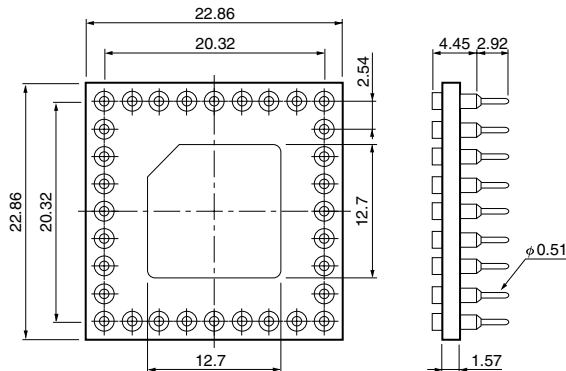

MATERIAL: Glass Epoxy

TACCA0094ED

● D Type Socket Assembly E6736 **SOLD SEPARATELY**

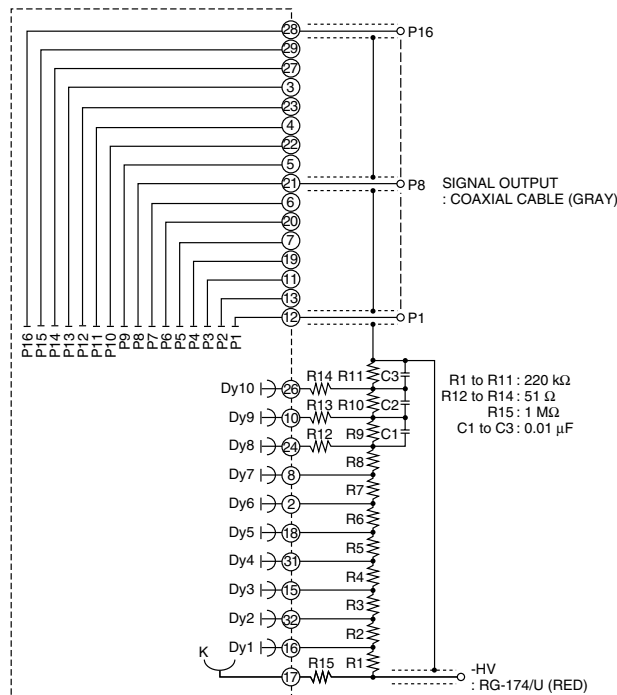
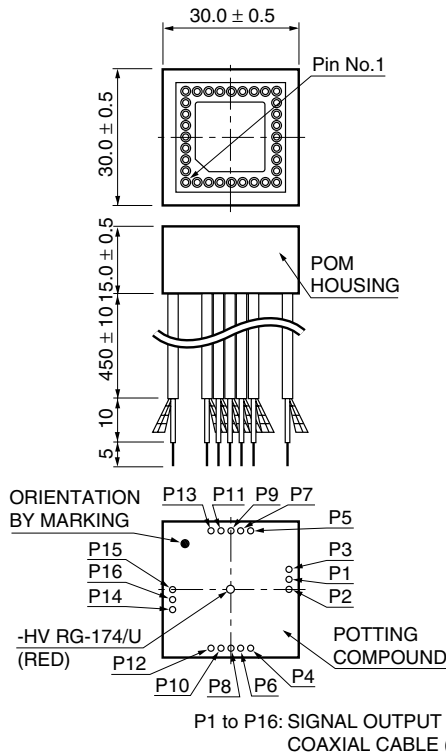

TACCA0158EE

⚠ WARNING ~ High Voltage ~

The product is operated at high voltage potential. Further, the metal housing of the product is connected to the photocathode (potential) so that it becomes a high voltage potential when the product is operated at a negative high voltage (anode grounded). Accordingly, extreme safety care must be taken for the electrical shock hazard to the operator or the damage to the other instruments.

* PATENT: USA Pat. No. 5410211 PATENT PENDING: JAPAN 12, USA 8, EUROPE 9

HAMAMATSU

WEB SITE <http://www.hamamatsu.com>

HAMAMATSU PHOTONICS K.K., Electron Tube Center

314-5, Shimokanzo, Toyooka-village, Iwata-gun, Shizuoka-ken, 438-0193, Japan, Telephone: (81)539/62-5248, Fax: (81)539/62-2205

U.S.A.: Hamamatsu Corporation: 360 Foothill Road, P. O. Box 6910, Bridgewater, N.J. 08807-0910, U.S.A., Telephone: (1)908-231-0960, Fax: (1)908-231-1218 E-mail: usa@hamamatsu.com

Germany: Hamamatsu Photonics Deutschland GmbH: Arzbergerstr. 10, D-82211 Herrsching am Ammersee, Germany, Telephone: (49)8152-375-0, Fax: (49)8152-2658 E-mail: info@hamamatsu.de

France: Hamamatsu Photonics France S.A.R.L.: 8, Rue du Saule Trapu, Parc du Moulin de Massy, 91882 Massy Cedex, France, Telephone: (33)1 69 53 71 00, Fax: (33)1 69 53 71 10 E-mail: infos@hamamatsu.fr

United Kingdom: Hamamatsu Photonics UK Limited: 2 Howard Court, 10 Tewin Road Welwyn Garden City Hertfordshire AL7 1BW, United Kingdom, Telephone: 44-(0)1707-294888, Fax: 44(0)1707-325777 E-mail: info@hamamatsu.co.uk

North Europe: Hamamatsu Photonics Norden AB: Smidesvägen 12, SE-171-41 SOLNA, Sweden, Telephone: (46)8-509-031-00, Fax: (46)8-509-031-01 E-mail: info@hamamatsu.se

Italy: Hamamatsu Photonics Italia: S.R.L.: Strada della Moia, 1/E, 20020 Arese, (Milano), Italy, Telephone: (39)02-935 81 733, Fax: (39)02-935 81 741 E-mail: info@hamamatsu.it

TPMH1285E01
MAY 2003 IP
Printed in Japan (500)