



ELECTROSTATIC SENSITIVE DEVICE
OBSERVE HANDLING PRECAUTIONS

MITSUBISHI RF MOSFET MODULE

RA30H1317M

RoHS Compliance , 135-175MHz 30W 12.5V 2 Stage Amp. For MOBILE RADIO

DESCRIPTION

The RA30H1317M is a 30-watt RF MOSFET Amplifier Module for 12.5-volt mobile radios that operate in the 135- to 175-MHz range.

The battery can be connected directly to the drain of the enhancement-mode MOSFET transistors. Without the gate voltage ($V_{GG}=0V$), only a small leakage current flows into the drain and the RF input signal attenuates up to 60 dB. The output power and drain current increase as the gate voltage increases. With a gate voltage around 3.5V (minimum), output power and drain current increases substantially. The nominal output power becomes available at 4V (typical) and 5V (maximum). At $V_{GG}=5V$, the typical gate current is 1 mA.

This module is designed for non-linear FM modulation, but may also be used for linear modulation by setting the drain quiescent current with the gate voltage and controlling the output power with the input power.

FEATURES

- Enhancement-Mode MOSFET Transistors ($I_{DD}\approx 0$ @ $V_{DD}=12.5V$, $V_{GG}=0V$)
- $P_{out}>30W$, $\eta_T>40\%$ @ $V_{DD}=12.5V$, $V_{GG}=5V$, $P_{in}=50mW$
- Broadband Frequency Range: 135-175MHz
- Low-Power Control Current $I_{GG}=1mA$ (typ) at $V_{GG}=5V$
- Module Size: 66 x 21 x 9.88 mm
- Linear operation is possible by setting the quiescent drain current with the gate voltage and controlling the output power with the input power

RoHS COMPLIANCE

- RA30H1317M-101 is a RoHS compliant products.
 - RoHS compliance is indicate by the letter "G" after the Lot Marking.
 - This product include the lead in the Glass of electronic parts and the lead in electronic Ceramic parts.
- How ever ,it applicable to the following exceptions of RoHS Directions.
- 1.Lead in the Glass of a cathode-ray tube, electronic parts, and fluorescent tubes.
 - 2.Lead in electronic Ceramic parts.

ORDERING INFORMATION:

ORDER NUMBER	SUPPLY FORM
RA30H1317M-101	Antistatic tray, 10 modules/tray

BLOCK DIAGRAM

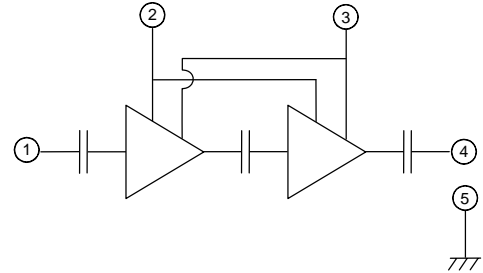

- ① RF Input (P_{in})
- ② Gate Voltage (V_{GG}), Power Control
- ③ Drain Voltage (V_{DD}), Battery
- ④ RF Output (P_{out})
- ⑤ RF Ground (Case)

PACKAGE CODE: H2S



MAXIMUM RATINGS ($T_{case}=+25^{\circ}\text{C}$, unless otherwise specified)

SYMBOL	PARAMETER	CONDITIONS	RATING	UNIT
V_{DD}	Drain Voltage	$V_{GG}<5\text{V}$	17	V
V_{GG}	Gate Voltage	$V_{DD}<12.5\text{V}$, $P_{in}=0\text{mW}$	6	V
P_{in}	Input Power	$f=135\text{-}175\text{MHz}$, $Z_G=Z_L=50\Omega$	100	mW
P_{out}	Output Power		45	W
$T_{case(OP)}$	Operation Case Temperature Range		-30 to +110	$^{\circ}\text{C}$
T_{stg}	Storage Temperature Range		-40 to +110	$^{\circ}\text{C}$

The above parameters are independently guaranteed.

ELECTRICAL CHARACTERISTICS ($T_{case}=+25^{\circ}\text{C}$, $Z_G=Z_L=50\Omega$, unless otherwise specified)

SYMBOL	PARAMETER	CONDITIONS	MIN	TYP	MAX	UNIT
f	Frequency Range		135		175	MHz
P_{out}	Output Power	$V_{DD}=12.5\text{V}$, $V_{GG}=5\text{V}$, $P_{in}=50\text{mW}$	30			W
η_T	Total Efficiency		40			%
$2f_o$	2 nd Harmonic				-25	dBc
ρ_{in}	Input VSWR				3:1	—
I_{GG}	Gate Current				1	mA
—	Stability	$V_{DD}=10.0\text{-}15.2\text{V}$, $P_{in}=25\text{-}70\text{mW}$, $P_{out}<40\text{W}$ (V_{GG} control), Load VSWR=3:1	No parasitic oscillation			—
—	Load VSWR Tolerance	$V_{DD}=15.2\text{V}$, $P_{in}=50\text{mW}$, $P_{out}=30\text{W}$ (V_{GG} control), Load VSWR=20:1	No degradation or destroy			—

All parameters, conditions, ratings, and limits are subject to change without notice.



TYPICAL PERFORMANCE ($T_{case}=+25^{\circ}C$, $Z_G=Z_L=50\Omega$, unless otherwise specified)

OUTPUT POWER, TOTAL EFFICIENCY, and INPUT VSWR versus FREQUENCY

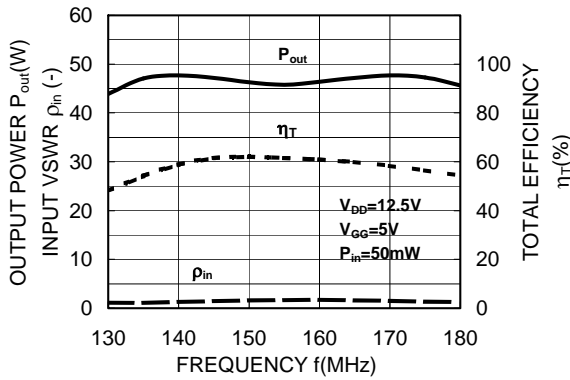

2nd, 3rd HARMONICS versus FREQUENCY

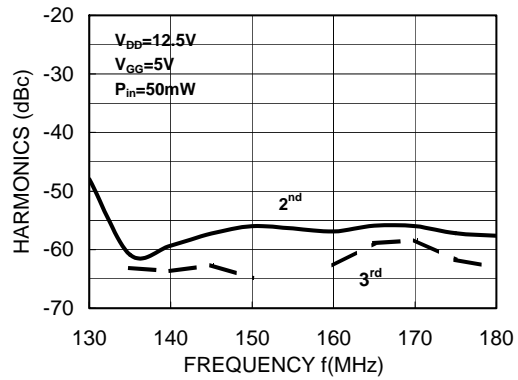

OUTPUT POWER, POWER GAIN and DRAIN CURRENT versus INPUT POWER

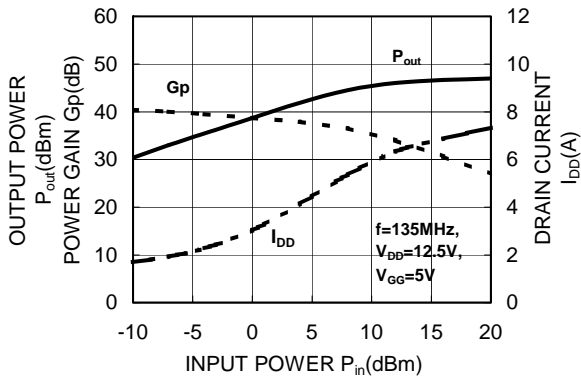

OUTPUT POWER, POWER GAIN and DRAIN CURRENT versus INPUT POWER

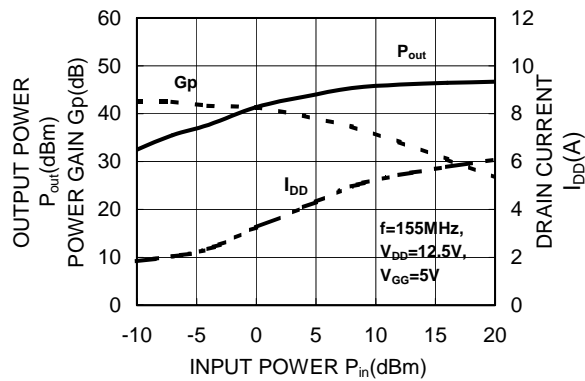

OUTPUT POWER, POWER GAIN and DRAIN CURRENT versus INPUT POWER

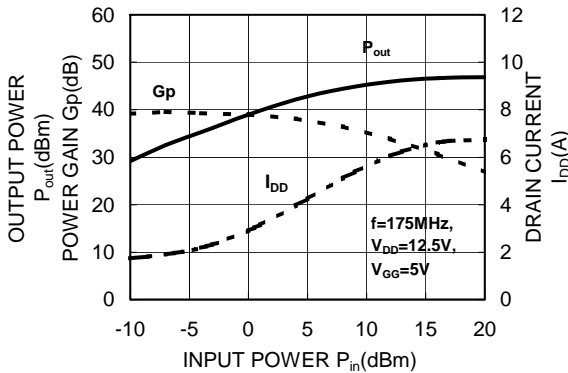

OUTPUT POWER and DRAIN CURRENT versus DRAIN VOLTAGE

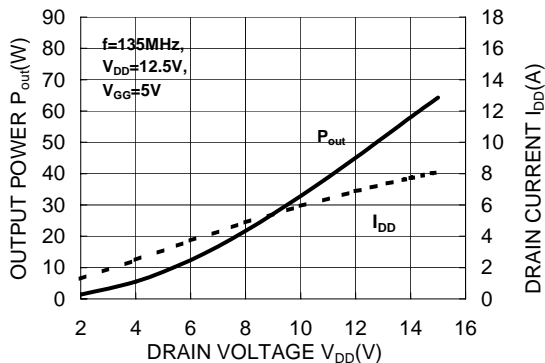

OUTPUT POWER and DRAIN CURRENT versus DRAIN VOLTAGE

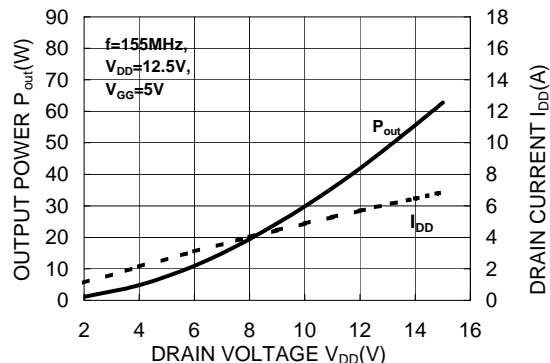



TYPICAL PERFORMANCE ($T_{case}=+25^{\circ}C$, $Z_G=Z_L=50\Omega$, unless otherwise specified)

OUTPUT POWER and DRAIN CURRENT
versus DRAIN VOLTAGE

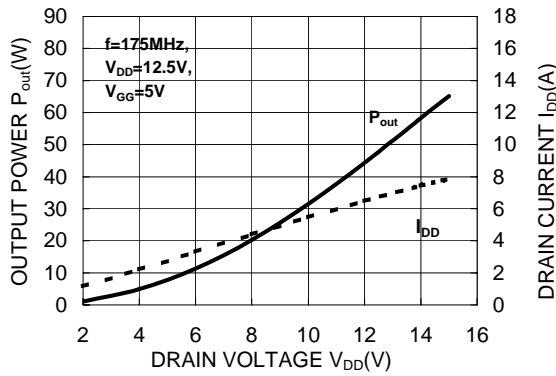

OUTPUT POWER and DRAIN CURRENT
versus GATE VOLTAGE

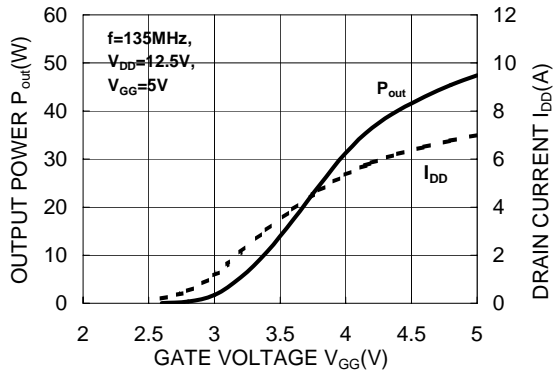

OUTPUT POWER and DRAIN CURRENT
versus GATE VOLTAGE

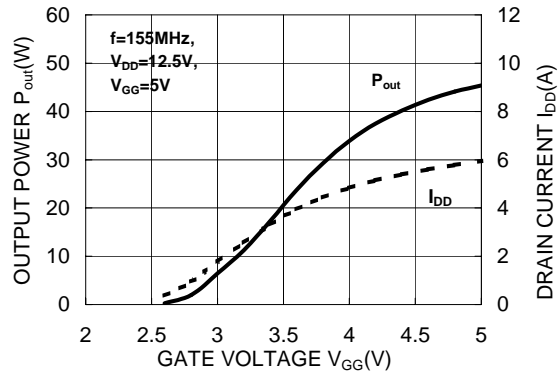

OUTPUT POWER and DRAIN CURRENT
versus GATE VOLTAGE

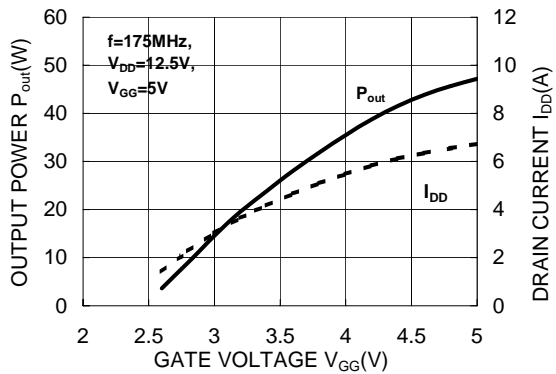



OUTLINE DRAWING (mm)

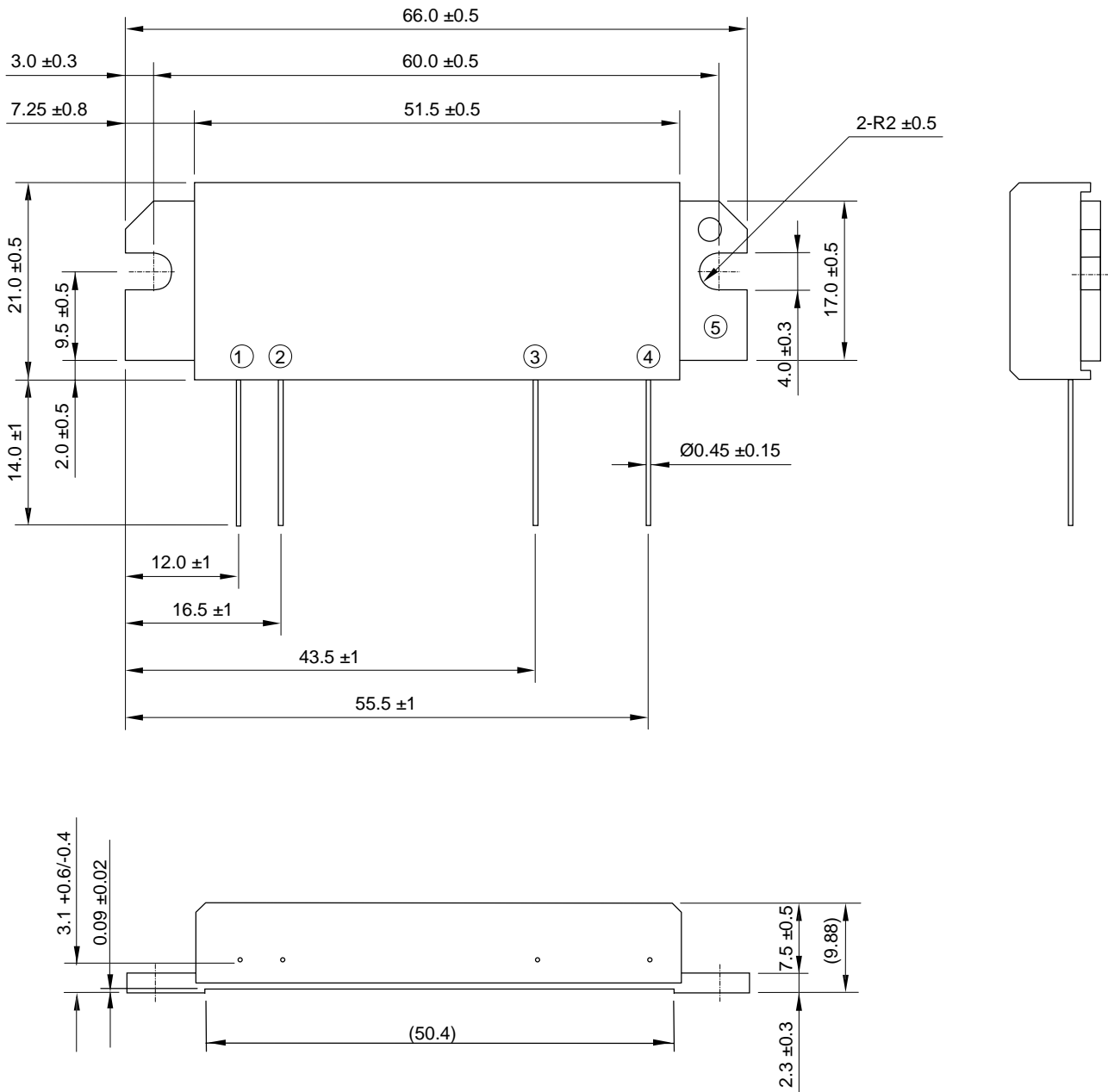

- ① RF Input (P_{in})
- ② Gate Voltage (V_{GG})
- ③ Drain Voltage (V_{DD})
- ④ RF Output (P_{out})
- ⑤ RF Ground (Case)



TEST BLOCK DIAGRAM

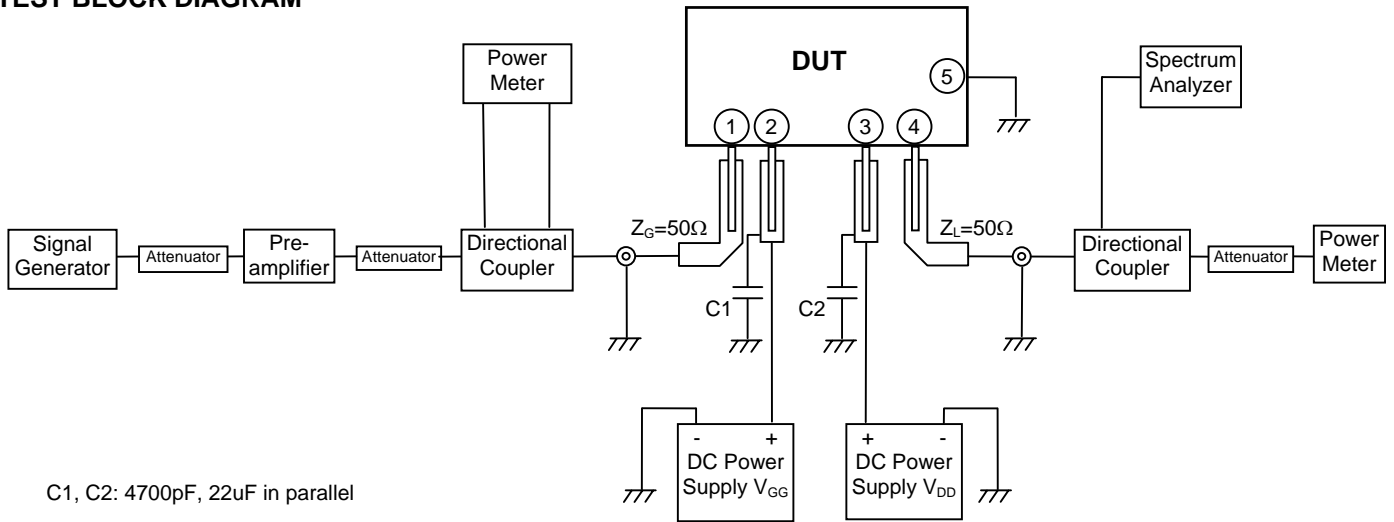

- ① RF Input (P_{in})
- ② Gate Voltage (V_{GG})
- ③ Drain Voltage (V_{DD})
- ④ RF Output (P_{out})
- ⑤ RF Ground (Case)

EQUIVALENT CIRCUIT

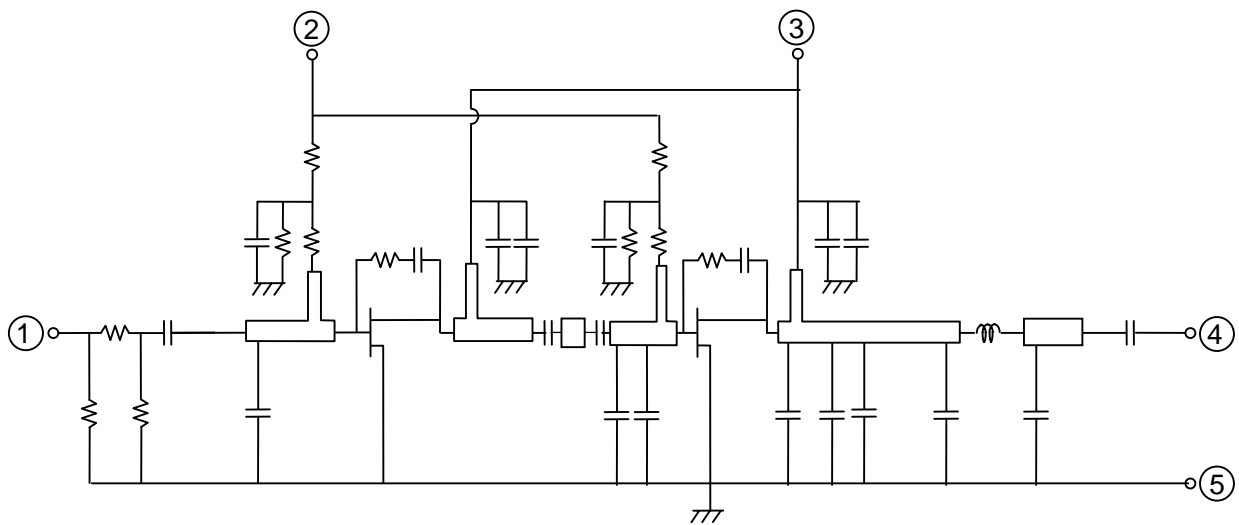



PRECAUTIONS, RECOMMENDATIONS, and APPLICATION INFORMATION:

Construction:

This module consists of an alumina substrate soldered onto a copper flange. For mechanical protection, a plastic cap is attached with silicone. The MOSFET transistor chips are die bonded onto metal, wire bonded to the substrate, and coated with resin. Lines on the substrate (eventually inductors), chip capacitors, and resistors form the bias and matching circuits. Wire leads soldered onto the alumina substrate provide the DC and RF connection. Following conditions must be avoided:

- a) Bending forces on the alumina substrate (for example, by driving screws or from fast thermal changes)
- b) Mechanical stress on the wire leads (for example, by first soldering then driving screws or by thermal expansion)
- c) Defluxing solvents reacting with the resin coating on the MOSFET chips (for example, Trichloroethylene)
- d) Frequent on/off switching that causes thermal expansion of the resin
- e) ESD, surge, overvoltage in combination with load VSWR, and oscillation

ESD:

This MOSFET module is sensitive to ESD voltages down to 1000V. Appropriate ESD precautions are required.

Mounting:

Heat sink flatness must be less than 50 μm (a heat sink that is not flat or particles between module and heat sink may cause the ceramic substrate in the module to crack by bending forces, either immediately when driving screws or later when thermal expansion forces are added).

A thermal compound between module and heat sink is recommended for low thermal contact resistance and to reduce the bending stress on the ceramic substrate caused by the temperature difference to the heat sink.

The module must first be screwed to the heat sink, then the leads can be soldered to the printed circuit board. M3 screws are recommended with a tightening torque of 0.4 to 0.6 Nm.

Soldering and Defluxing:

This module is designed for manual soldering.

The leads must be soldered after the module is screwed onto the heat sink.

The temperature of the lead (terminal) soldering should be lower than 350°C and shorter than 3 second.

Ethyl Alcohol is recommend for removing flux. Trichloroethylene solvents must not be used (they may cause bubbles in the coating of the transistor chips which can lift off the bond wires).

Thermal Design of the Heat Sink:

At P_{out}=30W, V_{DD}=12.5V and P_{in}=50mW each stage transistor operating conditions are:

Stage	P _{in} (W)	P _{out} (W)	R _{th(ch-case)} (°C/W)	I _{DD} @ η _T =40% (A)	V _{DD} (V)
1 st	0.05	4.5	23.0	0.47	12.5
2 nd	4.5	30.0	1.2	5.5	

The channel temperatures of each stage transistor T_{ch} = T_{case} + (V_{DD} × I_{DD} - P_{out} + P_{in}) × R_{th(ch-case)} are:

$$T_{ch1} = T_{case} + (12.5V \times 0.47A - 4.5W + 0.05W) \times 23.0^{\circ}C/W = T_{case} + 32.8^{\circ}C$$

$$T_{ch2} = T_{case} + (12.5V \times 5.5A - 30.0W + 4.5W) \times 1.2^{\circ}C/W = T_{case} + 51.9^{\circ}C$$

For long-term reliability, it is best to keep the module case temperature (T_{case}) below 90°C. For an ambient temperature T_{air}=60°C and P_{out}=30W, the required thermal resistance R_{th(case-air)} = (T_{case} - T_{air}) / ((P_{out} / η_T) - P_{out} + P_{in}) of the heat sink, including the contact resistance, is:

$$R_{th(case-air)} = (90^{\circ}C - 60^{\circ}C) / (30W/40\% - 30W + 0.05W) = 0.67^{\circ}C/W$$

When mounting the module with the thermal resistance of 0.67 °C/W, the channel temperature of each stage transistor is:

$$T_{ch1} = T_{air} + 62.8^{\circ}C$$

$$T_{ch2} = T_{air} + 81.9^{\circ}C$$

The 175°C maximum rating for the channel temperature ensures application under derated conditions.



Output Power Control:

Depending on linearity, the following two methods are recommended to control the output power:

a) Non-linear FM modulation:

By the gate voltage (V_{GG}).

When the gate voltage is close to zero, the RF input signal is attenuated up to 60 dB and only a small leakage current flows from the battery into the drain.

Around $V_{GG}=4V$, the output power and drain current increases substantially.

Around $V_{GG}=4.5V$ (typical) to $V_{GG}=5V$ (maximum), the nominal output power becomes available.

b) Linear AM modulation:

By RF input power P_{in} .

The gate voltage is used to set the drain's quiescent current for the required linearity.

Oscillation:

To test RF characteristics, this module is put on a fixture with two bias decoupling capacitors each on gate and drain, a 4.700 pF chip capacitor, located close to the module, and a 22 μF (or more) electrolytic capacitor.

When an amplifier circuit around this module shows oscillation, the following may be checked:

a) Do the bias decoupling capacitors have a low inductance pass to the case of the module?

b) Is the load impedance $Z_L=50\Omega$?

c) Is the source impedance $Z_G=50\Omega$?

Frequent on/off switching:

In base stations, frequent on/off switching can cause thermal expansion of the resin that coats the transistor chips and can result in reduced or no output power. The bond wires in the resin will break after long-term thermally induced mechanical stress.

Quality:

Mitsubishi Electric is not liable for failures resulting from base station operation time or operating conditions exceeding those of mobile radios.

This module technology results from more than 20 years of experience, field proven in tens of millions of mobile radios. Currently, most returned modules show failures such as ESD, substrate crack, and transistor burnout, which are caused by improper handling or exceeding recommended operating conditions. Few degradation failures are found.

Keep safety first in your circuit designs!

Mitsubishi Electric Corporation puts the maximum effort into making semiconductor products better and more reliable, but there is always the possibility that trouble may occur. Trouble with semiconductors may lead to personal injury, fire or property damage. Remember to give due consideration to safety when making your circuit designs, with appropriate measures such as (i) placement of substitutive, auxiliary circuits, (ii) use of non-flammable material, or (iii) prevention against any malfunction or mishap.