

**RoHS Compliant & Pb-Free Product**

**Typical Applications**

- Cordless Phones
- Wireless Computer Peripherals
- Wireless Security Systems
- General Purpose RF Switching
- Commercial and Consumer Systems

**Product Description**

The RF2436 is a very low-cost transmit/receive GaAs MESFET switch. The device can handle power levels as high as +28dBm and spans a frequency range from DC to 2500MHz. The switch will operate from power supply voltages as low as 1.5V and as high as 6V with a CMOS logic driver for the control input. No negative voltage is required, and current consumption is very low. VSWR for the active channel (transmit or receive) is 1.1:1. The device is housed in a very small industry-standard SOT 5-lead plastic package.

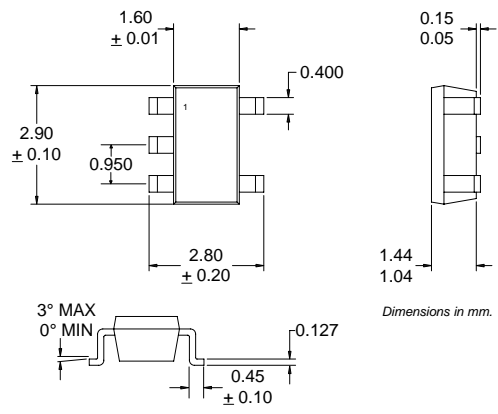

**Optimum Technology Matching® Applied**

- |                                     |                                   |   |
|-------------------------------------|-----------------------------------|---|
| <input type="checkbox"/> Si BJT     | <input type="checkbox"/> GaAs HBT | <input checked="" type="checkbox"/> GaAs MESFET |
| <input type="checkbox"/> Si Bi-CMOS | <input type="checkbox"/> SiGe HBT | <input type="checkbox"/> Si CMOS                |
| <input type="checkbox"/> InGaP/HBT  | <input type="checkbox"/> GaN HEMT | <input type="checkbox"/> SiGe Bi-CMOS           |

Package Style: SOT-5

**Features**

- Single Positive Power Supply
- Low Current Consumption
- 1 dB Insertion Loss at 900MHz
- 24dB Crosstalk Isolation at 900MHz
- +27dBm Output P1dB

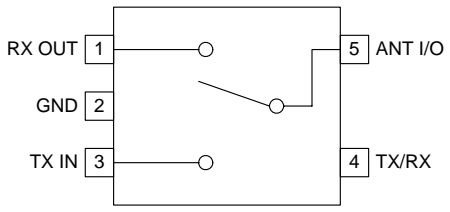

Functional Block Diagram

**Ordering Information**

RF2436	Transmit/Receive Switch
RF2436 PCBA	Fully Assembled Evaluation Board

RF Micro Devices, Inc.  
7628 Thorndike Road  
Greensboro, NC 27409, USA

Tel (336) 664 1233  
Fax (336) 664 0454  
<http://www.rfmd.com>

# RF2436

## Absolute Maximum Ratings

Parameter	Rating	Unit
Supply Voltage	0 to +8.0	V <sub>DC</sub>
Control Voltage	-1.0 to +6.0	V
Input RF Power	+30	dBm
Operating Ambient Temperature	-40 to +85	°C
Storage Temperature	-40 to +150	°C



Caution! ESD sensitive device.

RF Micro Devices believes the furnished information is correct and accurate at the time of this printing. RoHS marking based on EU Directive 2002/95/EC (at time of this printing). However, RF Micro Devices reserves the right to make changes to its products without notice. RF Micro Devices does not assume responsibility for the use of the described product(s).

Parameter	Specification			Unit	Condition
	Min.	Typ.	Max.		
<b>Overall</b>					T=25 °C, V <sub>DD</sub> =3.0V, Freq=900MHz
Frequency Range		DC to 2500		MHz	
Insertion Loss		1	2	dB	Transmit or receive mode.
Isolation	20	22		dB	Receive mode; ANT I/O to TX IN crosstalk
	20	24		dB	Transmit mode; ANT I/O to RXOUT crosstalk
RX OUT VSWR		1.1:1			Receive mode.
TX IN VSWR		1.1:1			Transmit mode.
Output P1dB		+27		dBm	
Output IP3		+39		dBm	
<b>Control Logic</b>					
CTRL Logic "Low" Voltage		0		V	Receive mode.
CTRL Logic "High" Voltage		0.7		V	Transmit mode.
<b>Power Supply</b>					
Voltage		3		V	Specifications
		1.5 to 6		V	Operating Limits
Current		5	10	μA	Receive mode.
		0.5	1	mA	Transmit mode.

Pin	Function	Description	Interface Schematic
1	RX OUT	Output pin for Receive mode. VSWR is 1.1:1 when Receive mode is selected and highly capacitive when Transmit mode is selected.	
2	GND	Ground connection. For best performance, keep traces physically short and connect immediately to the ground plane.	
3	TX IN	Input pin for Transmit mode. The input VSWR is 1.1:1 when Transmit mode is selected and highly capacitive when Receive mode is selected.	
4	TX/RX	Transmit Mode/Receive Mode control pin. A "low" level chooses Receive mode; a "high" level chooses Transmit mode. CMOS logic may be used to drive the control input.	
5	ANT I/O	Input/Output pin from/to antenna and power supply pin. This pin must be biased with VDD through a resistor.	

## Evaluation Board Schematic (Download [Bill of Materials](http://www.rfmd.com) from [www.rfmd.com](http://www.rfmd.com).)

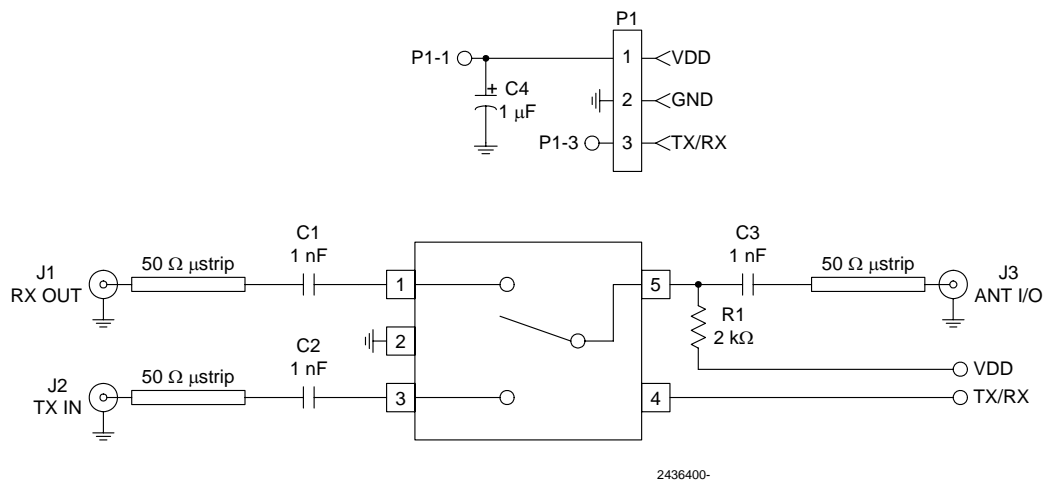

### Evaluation Board Layout

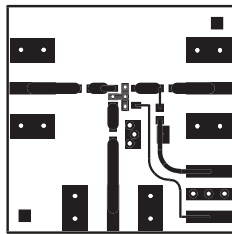
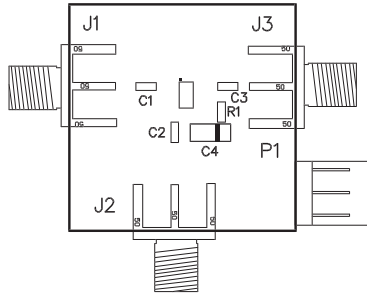

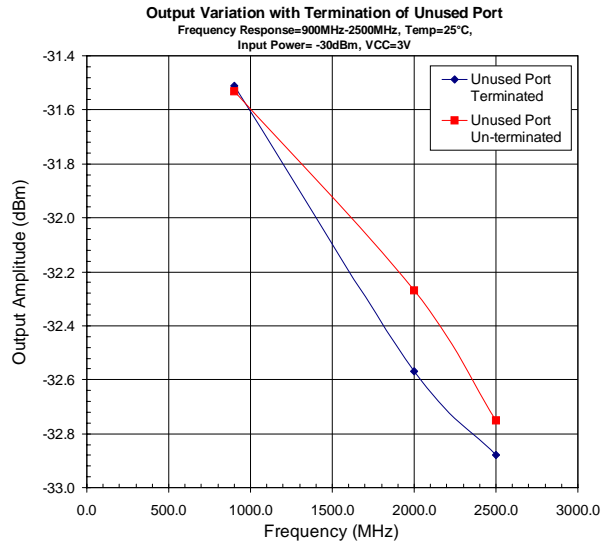
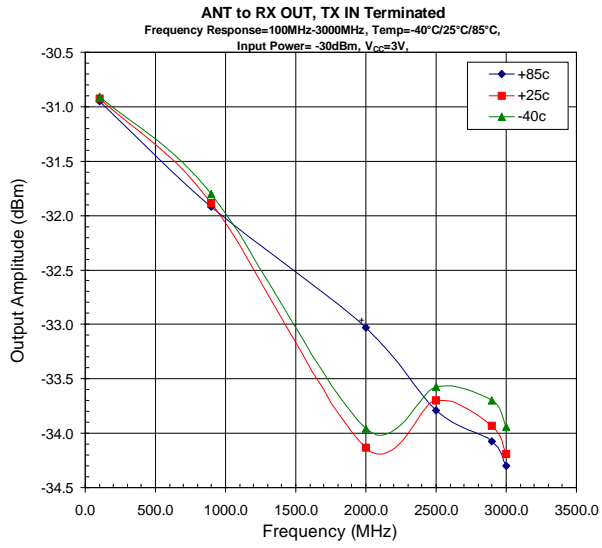

**RF2436**