

**SEMiX<sup>®</sup> 2**

## Trench IGBT Modules

**SEMiX 452GB126HD**

**SEMiX 452GAL126HD**

**SEMiX 452GAR126HD**

Preliminary Data

### Features

- Homogeneous Si
- Trench = Trenchgate technology
- $V_{CE(sat)}$  with positive temperature coefficient
- High short circuit capability

### Typical Applications

- AC inverter drives
- UPS
- Electronic welders

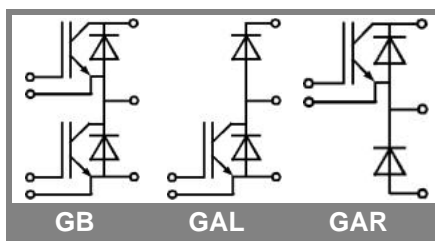

Absolute Maximum Ratings		$T_{case} = 25^{\circ}C$ , unless otherwise specified	
Symbol	Conditions	Values	Units
<b>IGBT</b>			
$V_{CES}$		1200	V
$I_C$	$T_c = 25 (80) ^{\circ}C$	470 (330)	A
$I_{CRM}$	$t_p = 1 \text{ ms}$	600	A
$V_{GES}$		$\pm 20$	V
$T_{vj}$ ( $T_{stg}$ )	$T_{OPERATION} \leq T_{stg}$	- 40 ... + 150 (125)	$^{\circ}C$
$V_{isol}$	AC, 1 min.	4000	V
<b>Inverse diode</b>			
$I_F$	$T_c = 25 (80) ^{\circ}C$	350 (240)	A
$I_{FRM}$	$t_p = 1 \text{ ms}$	600	A
$I_{FSM}$	$t_p = 10 \text{ ms}; \text{sin.}; T_j = 25 ^{\circ}C$	1900	A

Characteristics		$T_{case} = 25^{\circ}C$ , unless otherwise specified			
Symbol	Conditions	min.	typ.	max.	Units
<b>IGBT</b>					
$V_{GE(th)}$	$V_{GE} = V_{CE}, I_C = 12 \text{ mA}$	5	5,8	6,5	V
$I_{CES}$	$V_{GE} = 0, V_{CE} = V_{CES}, T_j = 25 (125) ^{\circ}C$			2	mA
$V_{CE(TO)}$	$T_j = 25 (125) ^{\circ}C$	1 (0,9)		1,2 (1,1)	V
$r_{CE}$	$V_{GE} = 15 \text{ V}, T_j = 25 (125) ^{\circ}C$	2,2 (3,7)		3,2 (4,5)	m $\Omega$
$V_{CE(sat)}$	$I_{Cnom} = 300 \text{ A}, V_{GE} = 15 \text{ V}, T_j = 25 (125) ^{\circ}C$ , chip level	1,7 (2)		2,15 (2,45)	V
$C_{ies}$	under following conditions		22		nF
$C_{oes}$	$V_{GE} = 0, V_{CE} = 25 \text{ V}, f = 1 \text{ MHz}$		1,2		nF
$C_{res}$			1		nF
$L_{CE}$			18		nH
$R_{CC'+EE'}$	terminal-chip, $T_c = 25 (125) ^{\circ}C$				m $\Omega$
$t_{d(on)}/t_r$	$V_{CC} = 600 \text{ V}, I_{Cnom} = 300 \text{ A}$		285 / 65		ns
$t_{d(off)}/t_f$	$V_{GE} = \pm 15 \text{ V}$		635 / 130		ns
$E_{on} (E_{off})$	$R_{Gon} = R_{Goff} = 2 \Omega, T_j = 125 ^{\circ}C$		35 (45)		mJ
<b>Inverse diode</b>					
$V_F = V_{EC}$	$I_{Fnom} = 300 \text{ A}; V_{GE} = 0 \text{ V}; T_j = 25 (125) ^{\circ}C$ , chip level	1,6 (1,6)		1,8 (1,8)	V
$V_{(TO)}$	$T_j = 25 (125) ^{\circ}C$	1 (0,8)		1,1 (0,9)	V
$r_T$	$T_j = 25 (125) ^{\circ}C$	2 (2,7)			m $\Omega$
$I_{RRM}$	$I_{Fnom} = 300 \text{ A}; T_j = 25 (125) ^{\circ}C$	(375)			A
$Q_{rr}$	$di/dt = 6200 \text{ A}/\mu\text{s}$	(75)			$\mu\text{C}$
$E_{rr}$	$V_{GE} = -15 \text{ V}$	(33)			mJ
<b>Thermal characteristics</b>					
$R_{th(j-c)}$	per IGBT			0,08	K/W
$R_{th(j-c)D}$	per Inverse Diode			0,18	K/W
$R_{th(j-c)FD}$	per FWD				K/W
$R_{th(c-s)}$	per module		0,045		K/W
<b>Temperature sensor</b>					
$R_{25}$	$T_c = 25 ^{\circ}C$		5 $\pm$ 5%		k $\Omega$
$B_{25/85}$	$R_2 = R_1 \exp[B(1/T_2 - 1/T_1)]; T[K]; B$		3420		K
<b>Mechanical data</b>					
$M_s/M_t$	to heatsink (M5) / for terminals (M6)	3/2,5		5 / 5	Nm
w			250		g

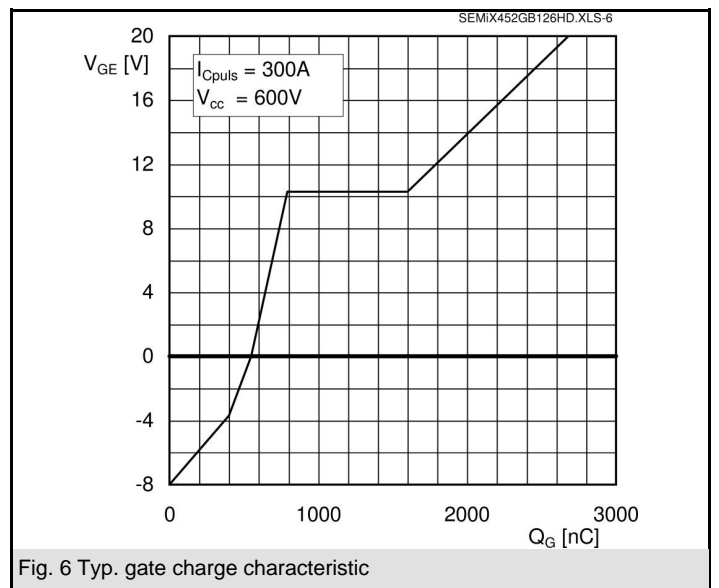
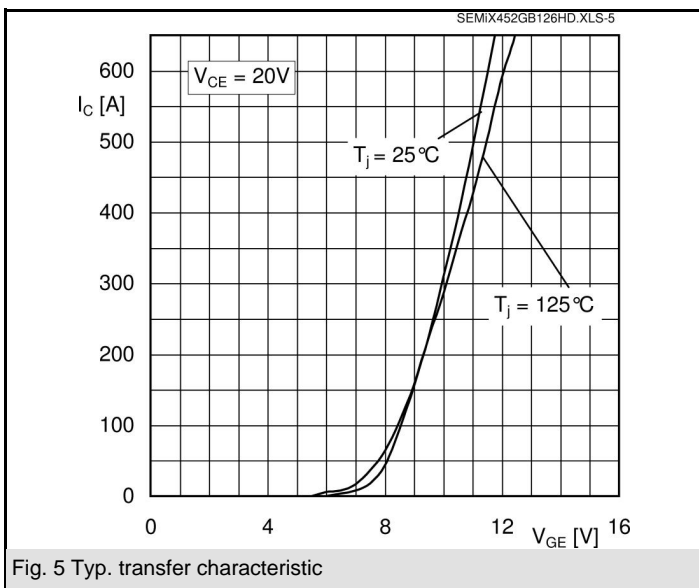
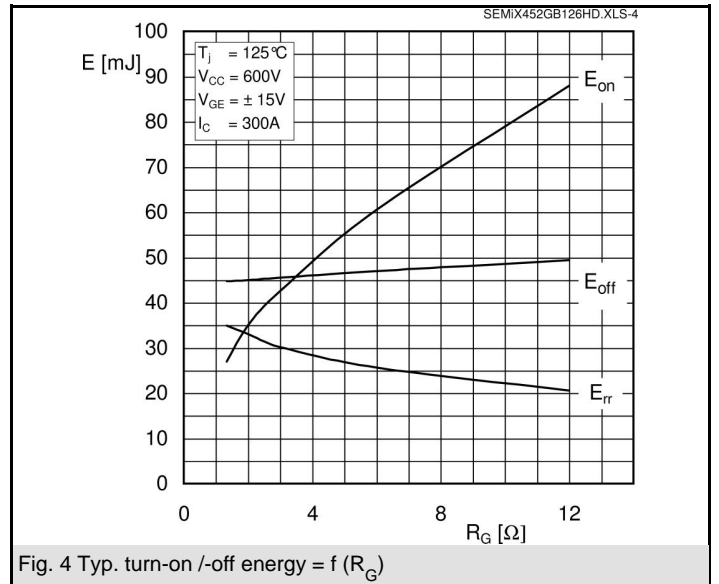
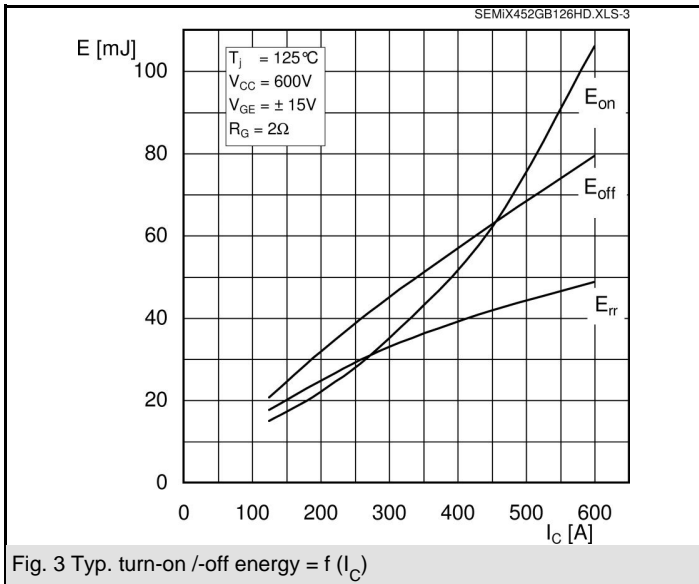
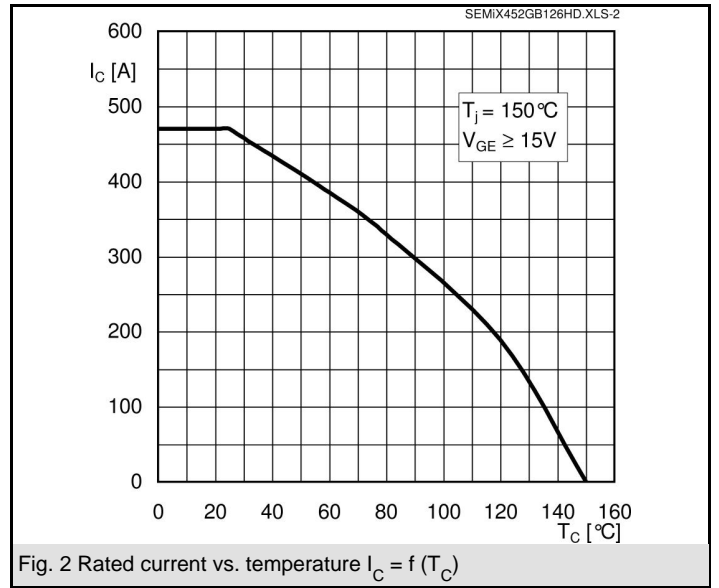
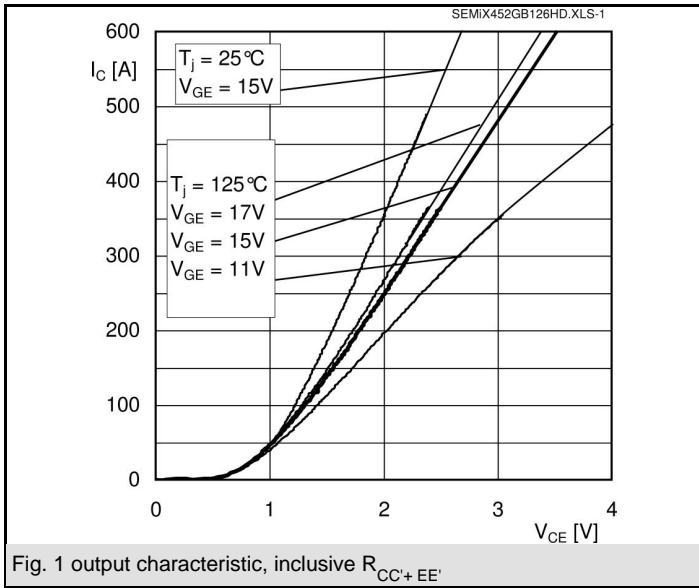

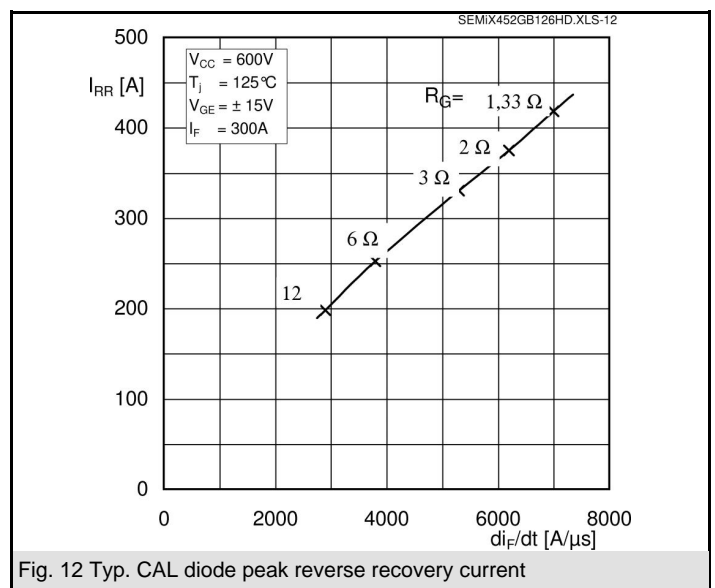
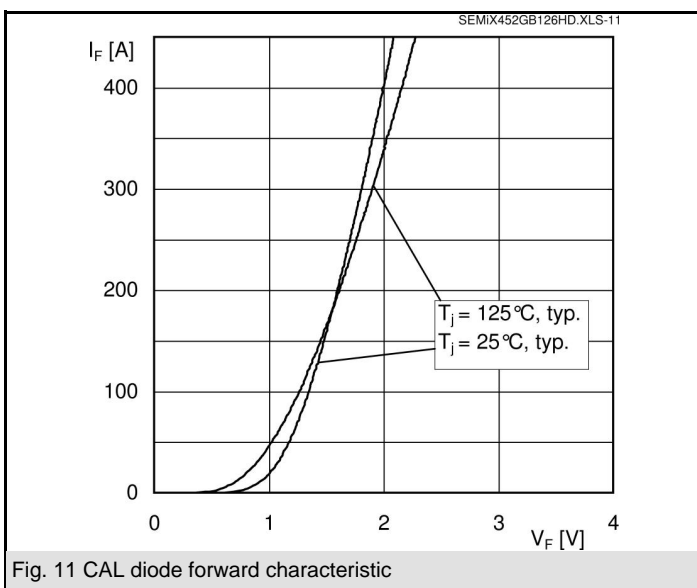
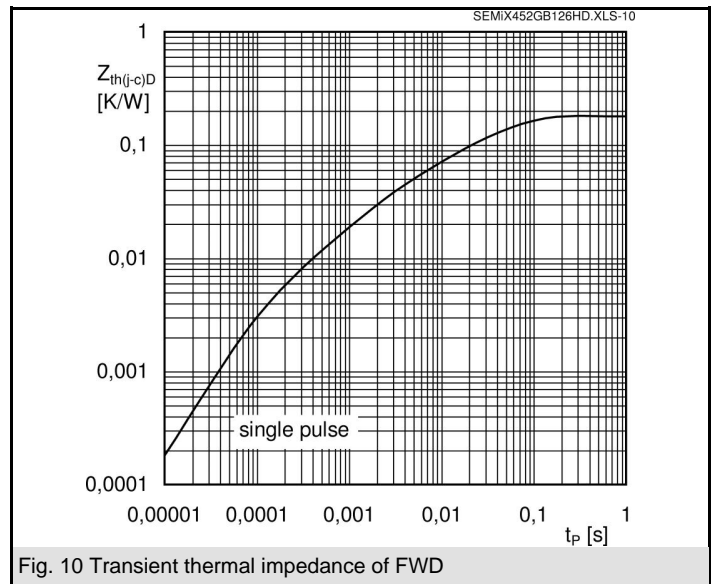
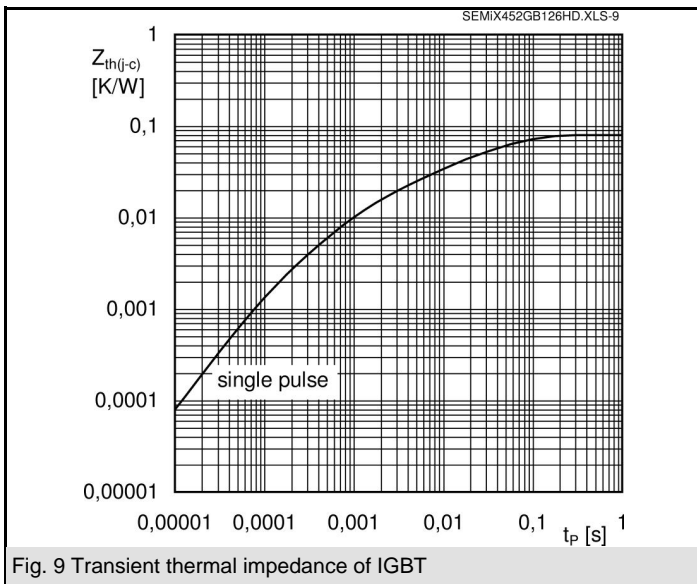
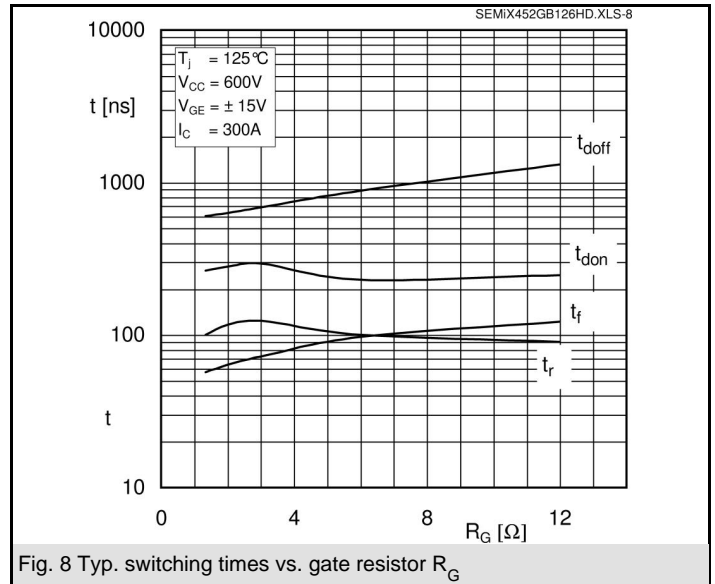
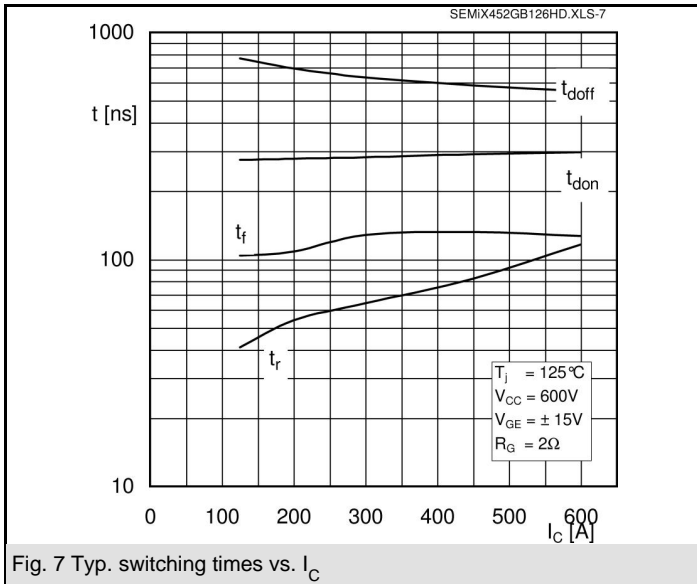

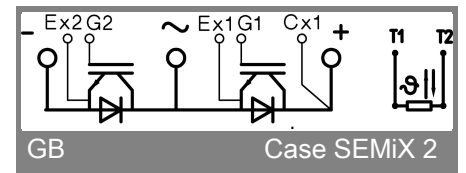
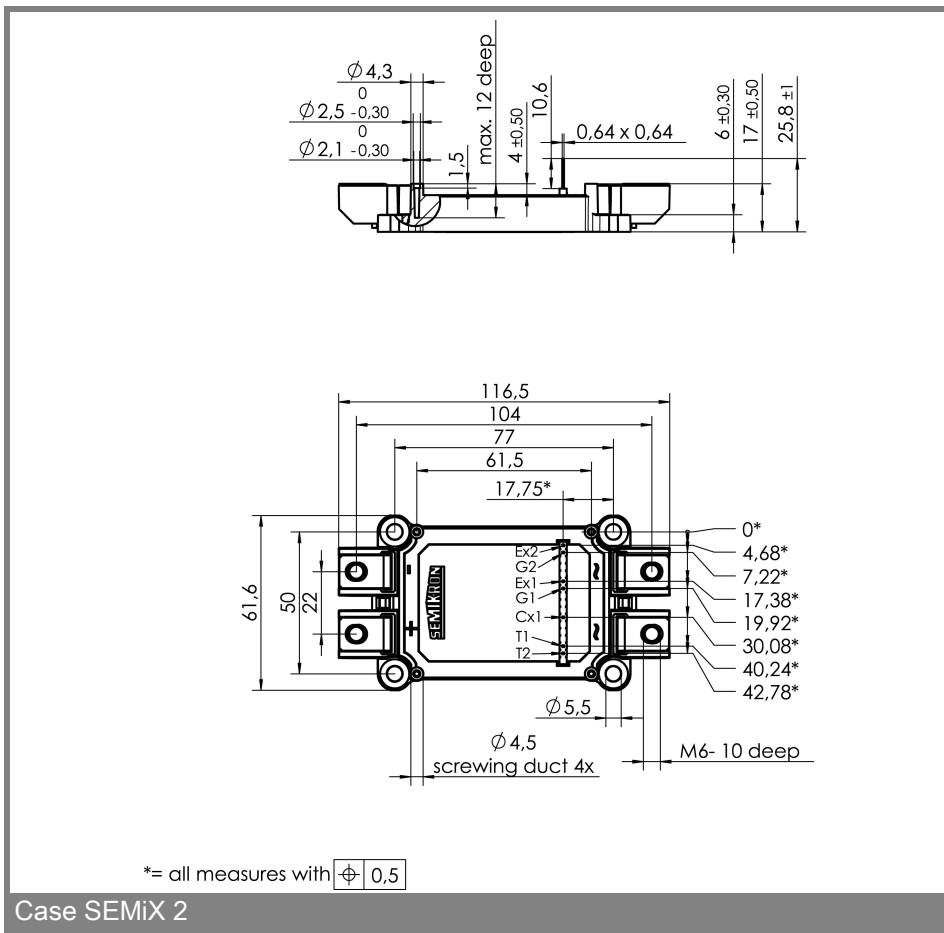
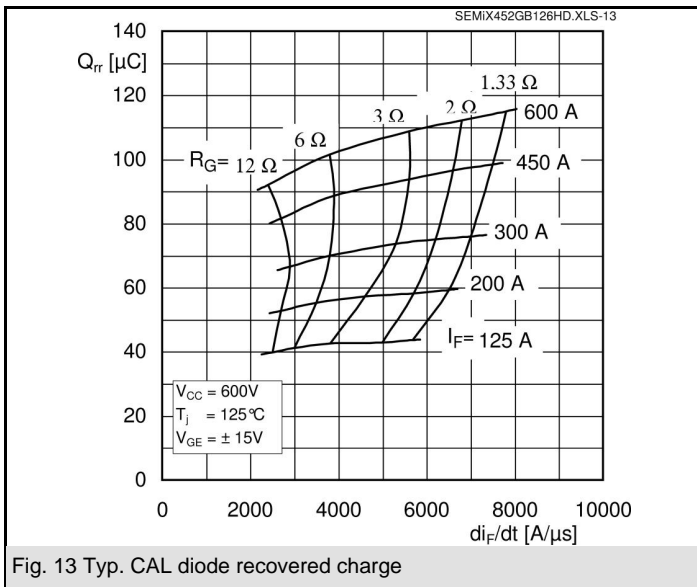

This is an electrostatic discharge sensitive device (ESDS), international standard IEC 60747-1, Chapter IX.

This technical information specifies semiconductor devices but promises no characteristics. No warranty or guarantee expressed or implied is made regarding delivery, performance or suitability.