

SIEMENS

SFH 204

SILICON FOUR QUADRANT PHOTODIODE

T-41-51

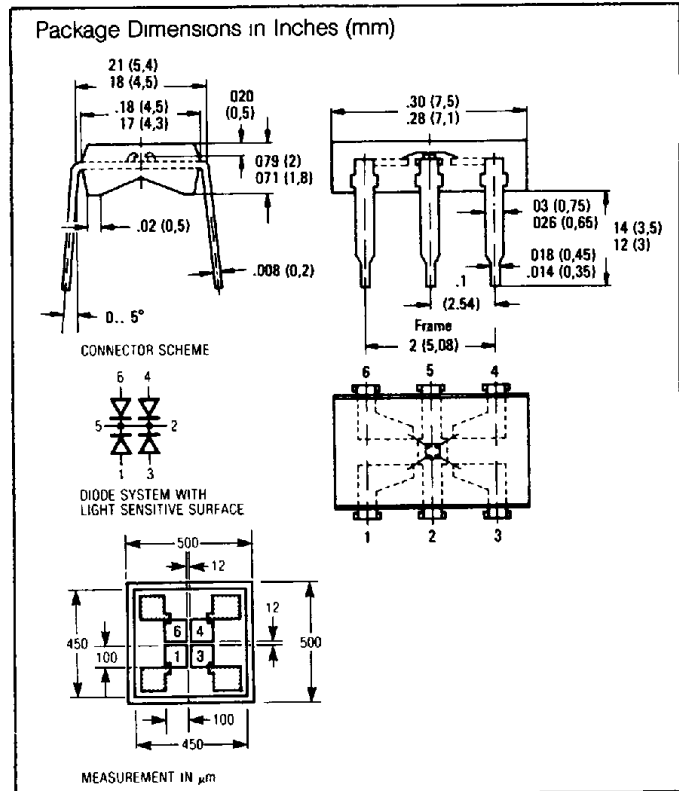
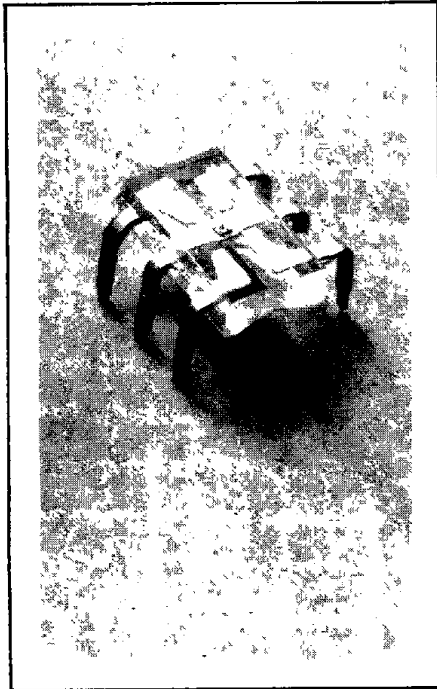

FEATURES

- Miniature Size
- Four Quadrant Active Sections
- Close Spacing of Contacts, 12 μm
- Can Determine If and By How Much a Light Source Has Deviated
- SMD Package Optional

DESCRIPTION

The SFH 204 silicon planar miniature four quadrant photodiode has application in edge drive, positioning, and path and corner scanning control devices. The active units are spaced at only 12 μm apart from individual contacts. It is therefore possible to get exact positioning with high definition.

Maximum Ratings

Reverse Voltage (V_R)	12 V
Operating and Storage Temperature Range (T , T_O)	-40 to +80°C
Soldering Temperature in a 2 mm Distance from the Case Bottom ($t \leq 3$ s) (T_S)	230°C
Power Dissipation (P_{TO})	40 mW

Characteristics ($T_{amb} = 25^\circ\text{C}$)

Photosensitivity ($V_R = 5$ V, Note 1)	S	0.13 (≥ 0.08)	nA/lx
Wavelength of Max. Photosensitivity	λ_{Smax}	850	nm
Spectral Range of Photosensitivity ($S = 10\%$ of S_{max})	λ	400 1100	nm
Radiant Sensitive Area	A	4×0.01	mm ²
Dimensions of the Radiant Sensitive Area	L x W	100×100	mm
Distance Between Chip Surface and Package Surface	H	0.5	mm
Half Angle	ϕ	60	Deg
Dark Current ($V_R = 10$ V)	I_R	$0.1 (\leq 2)$	nA
Spectral Photosensitivity ($\lambda = 850$ nm)	S_λ	0.35	A/W
Max. Deviation of Photosensitivity Between Diodes	Δ	± 10	%
Quantum Efficiency ($\lambda = 950$ nm)	η	0.45	$\frac{\text{Electrons}}{\text{Photon}}$

—Continued

T-41-51

Characteristics ($T_{amb} = 25^{\circ}\text{C}$)

Open Circuit Voltage ($E_V = 1000 \text{ lx}$, Note 1)	V_O	450 (≥ 380)	mV
Short Circuit Current ($E_V = 1000 \text{ lx}$, Note 1)	I_K	130 (≥ 80)	nA
Rise and Fall Time of the Photo-current from 10% to 90% and from 90% to 10% of the Final Value ($R_L = 1 \text{ K}\Omega$, $V_R = 5 \text{ V}$, $\lambda = 830 \text{ nm}$, $I_p = 45 \mu\text{A}$)	t_r, t_f	3	μs
Forward Voltage ($I_F = 100 \text{ mA}$, $E_o = 0$, $T_{amb} = 25^{\circ}\text{C}$)	V_F	1.3	V
Capacitance ($V_R = 0 \text{ V}$, $f = 1 \text{ MHz}$, $E_V = 0 \text{ lx}$)	C_0	2.0	pF
($V_R = 10 \text{ V}$, $f = 1 \text{ MHz}$, $E_V = 0 \text{ lx}$)	C_{10}	1.0	pF
Temperature Coefficient V_O	TC_V	-2.6	mV/K
Temperature Coefficient I_O	TC_I	0.18	%/K

¹ The illuminance indicated refers to unfiltered radiation of a tungsten filament lamp at a color temperature of 2856 K (standard light A in accordance with DIN 5033 and IEC publ 306-1)

Capacitance

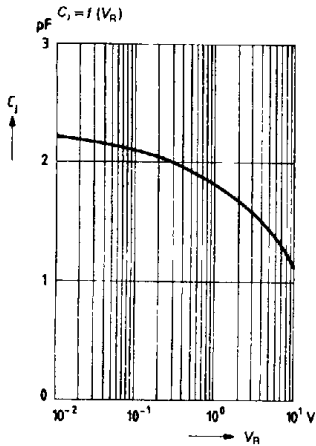

Power Dissipation

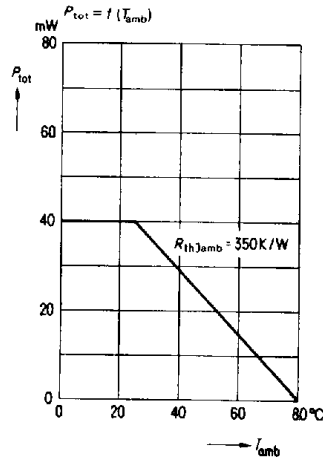

Relative spectral sensitivity

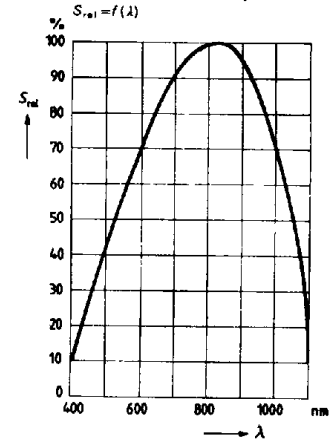

**Photocurrent $I_p = f(E_V)$
Open circuit voltage $V_L = f(E_V)$**

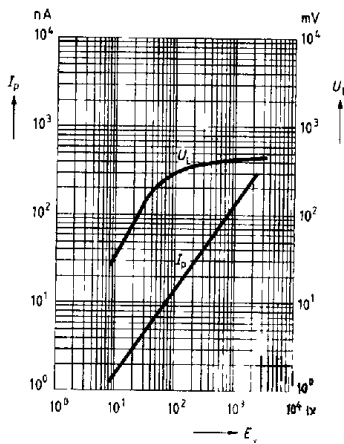

Directional characteristic

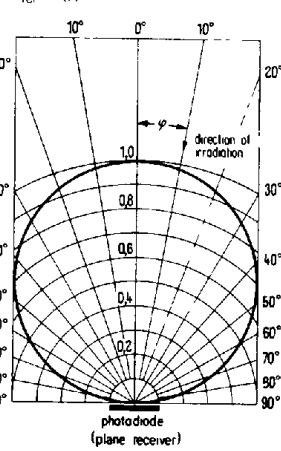

Photodiodes