

# SK 10 GD 126 ET

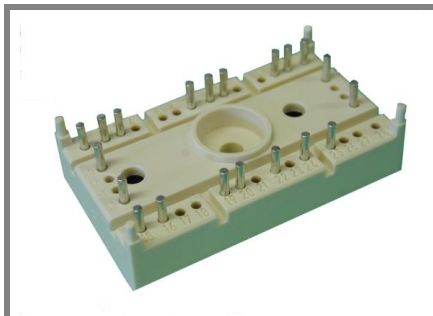

SEMITOP<sup>®</sup> 3

## 3-phase bridge inverter

SK 10 GD 126 ET

Preliminary Data

### Features

- Compact design
- One screw mounting
- Heat transfer and isolation through direct copper bonded aluminum oxide ceramic (DCB)
- Trench technology IGBT
- CAL High Density FWD
- Integrated NTC temperature sensor

### Typical Applications

- Inverter

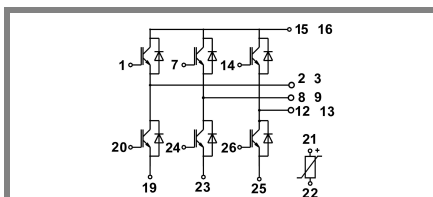

GD - ET

Absolute Maximum Ratings		$T_s = 25^\circ\text{C}$ , unless otherwise specified	
Symbol	Conditions	Values	Units
<b>IGBT - Inverter, Chopper</b>			
$V_{CES}$		1200	V
$I_C$	$T_s = 25$ (80) $^\circ\text{C}$	15 (11)	A
$I_{CM}$	$T_s = 25$ (80) $^\circ\text{C}$ , $t_p \leq 1$ ms	30 (22)	A
$V_{GES}$		$\pm 20$	V
$T_j$		-40 ... +150	$^\circ\text{C}$
<b>Diode - Inverter, Chopper</b>			
$I_F$	$T_s = 25$ (80) $^\circ\text{C}$	25 (17)	A
$I_{FM} = -I_{CM}$	$T_s = 25$ (70) $^\circ\text{C}$ , $t_p \leq 1$ ms	50 (34)	A
$T_j$		-40 ... +150	$^\circ\text{C}$
<b>Rectifier</b>			
$V_{RRM}$			V
$I_{FAV} / I_{TAV}$	$T_s = \text{ }^\circ\text{C}$		A
$I_{FSM} / I_{TSM}$	$t_p = \text{ms}$ , $\sin^\circ$ , $T_j = \text{ }^\circ\text{C}$		A
$I_t^2$	$t_p = \text{ms}$ , $\sin^\circ$ , $T_j = \text{ }^\circ\text{C}$		$\text{A}^2\text{s}$
$T_j$			$^\circ\text{C}$
$T_{sol}$	10s	260	$^\circ\text{C}$
$T_{stg}$		-40 ... +125	$^\circ\text{C}$
$V_{isol}$	AC, 1 min. /	2500 / 3000	V

Characteristics		$T_s = 25^\circ\text{C}$ , unless otherwise specified			
Symbol	Conditions	min.	typ.	max.	Units
<b>IGBT - Inverter, Chopper</b>					
$V_{CEsat}$	$I_C = 8$ A, $T_j = 25$ (125) $^\circ\text{C}$		1,7 (2,2)	2,1	V
$V_{GE(th)}$	$V_{GE} = V_{CE}$ , $I_C = 0,3$ mA	5	5,8	6,5	V
$V_{CE(TO)}$	$T_j = 25$ $^\circ\text{C}$ (125) $^\circ\text{C}$		1 (0,9)	1,2	V
$r_T$	$T_j = 25$ $^\circ\text{C}$ (125) $^\circ\text{C}$		87 (138)	113	m $\Omega$
$C_{ies}$	$V_{CE} = 25$ V, $V_{GE} = 0$ V, $f = 1$ MHz		0,7		nF
$C_{oes}$	$V_{CE} = 25$ V, $V_{GE} = 0$ V, $f = 1$ MHz		0,2		nF
$C_{res}$	$V_{CE} = 25$ V, $V_{GE} = 0$ V, $f = 1$ MHz		0,1		nF
$R_{th(j-s)}$	per IGBT			2	K/W
$t_{d(on)}$	under following conditions		85		ns
$t_r$	$V_{CC} = 600$ V, $V_{GE} = \pm 15$ V		30		ns
$t_{d(off)}$	$I_C = 8$ A, $T_j = 125$ $^\circ\text{C}$		430		ns
$t_f$	$R_{Gon} = R_{Goff} = 75$ $\Omega$		90		ns
$E_{on}$	inductive load		1		mJ
$E_{off}$			1		mJ
<b>Diode - Inverter, Chopper</b>					
$V_F = V_{EC}$	$I_F = 8$ A, $T_j = 25$ (125) $^\circ\text{C}$		1,9 (2)	2,2	V
$V_{(TO)}$	$T_j = 25$ $^\circ\text{C}$ (125) $^\circ\text{C}$		1 (0,8)	1,1 (0,9)	V
$r_T$	$T_j = 25$ $^\circ\text{C}$ (125) $^\circ\text{C}$		40 (53)	47	m $\Omega$
$R_{th(j-s)}$	per diode			2,1	K/W
$I_{RRM}$	under following conditions		21		A
$Q_{rr}$	$I_F = 15$ A, $V_R = 600$ V		3,5		$\mu\text{C}$
$E_{rr}$	$V_{GE} = 0$ V, $T_j = 125$ $^\circ\text{C}$		1,4		mJ
	$di_F/dt = 300$ A/ $\mu\text{s}$				
<b>Diode rectifier</b>					
$V_F$	$I_F = \text{A}$ , $T_j = 25$ $^\circ\text{C}$				V
$V_{(TO)}$	$T_j = \text{ }^\circ\text{C}$				V
$r_T$	$T_j = \text{ }^\circ\text{C}$				m $\Omega$
$R_{th(j-s)}$	per diode				K/W
<b>Temperatur sensor</b>					
$R_{ts}$	5 %, $T_r = 25$ (100) $^\circ\text{C}$		5000(493)		$\Omega$
<b>Mechanical data</b>					
w			30		g
$M_s$	Mounting torque			2,5	Nm

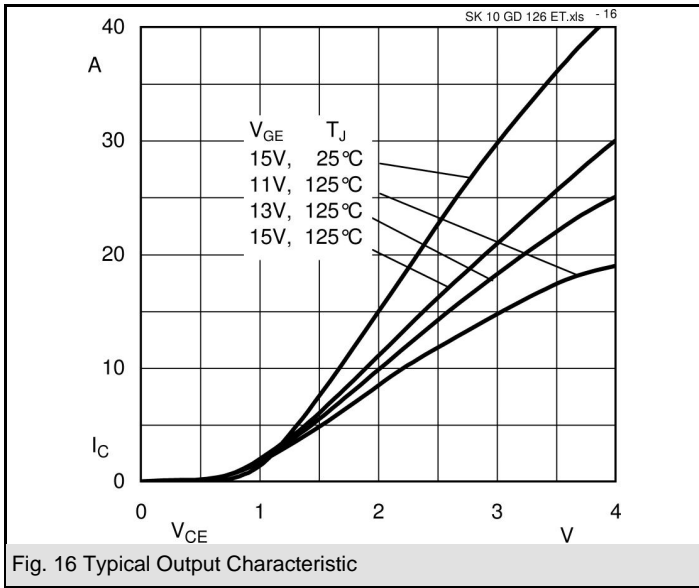

Fig. 16 Typical Output Characteristic

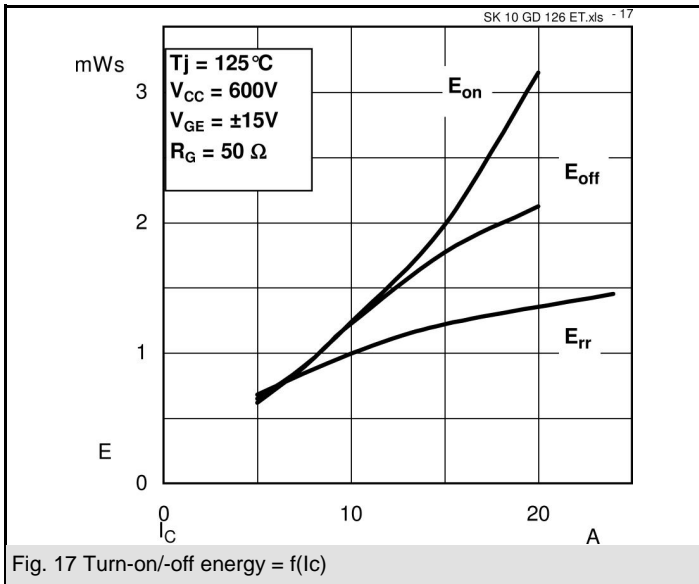

Fig. 17 Turn-on/-off energy =  $f(I_c)$

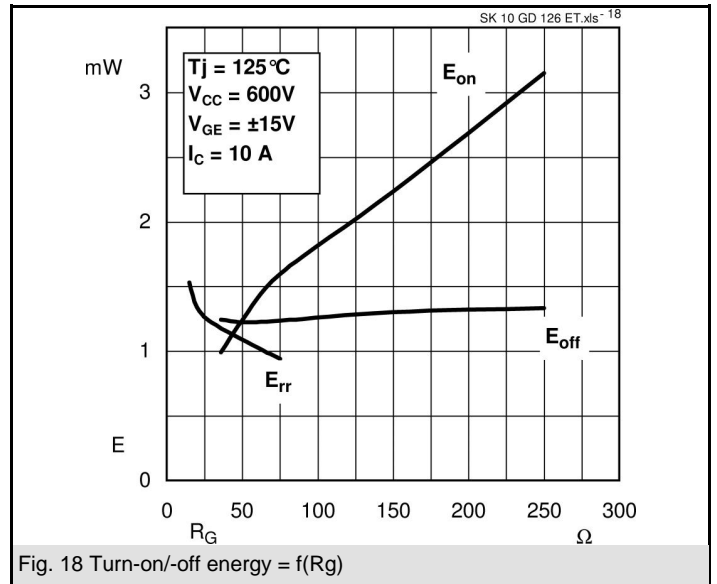

Fig. 18 Turn-on/-off energy =  $f(R_g)$

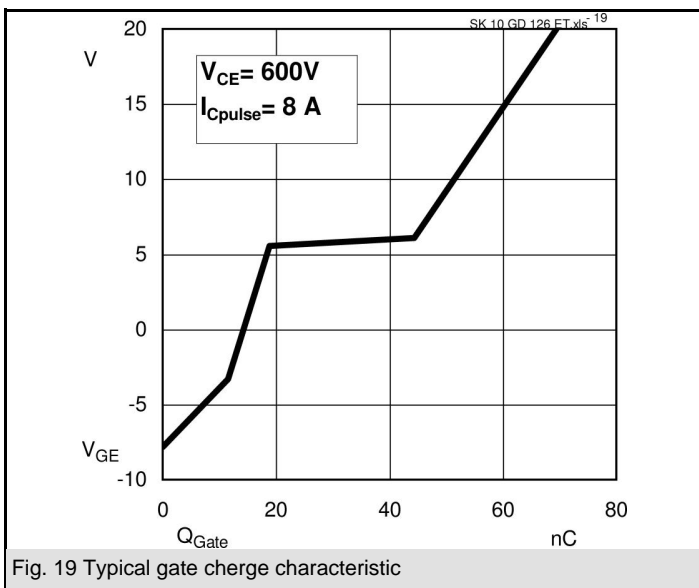
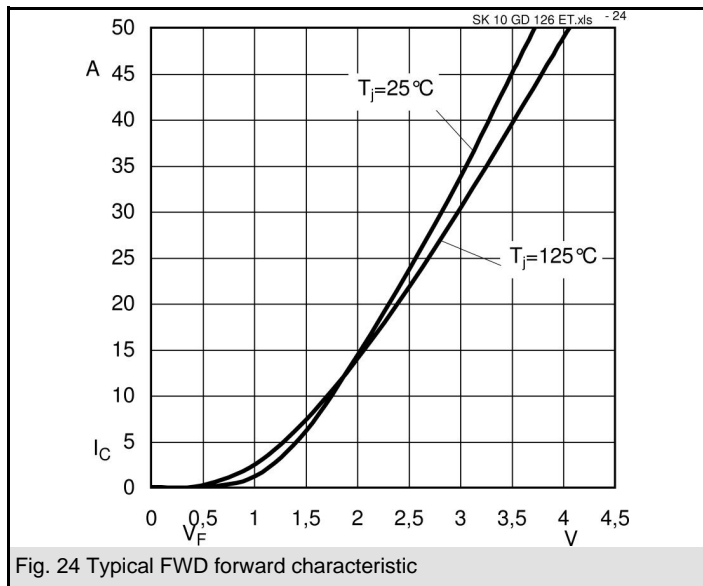
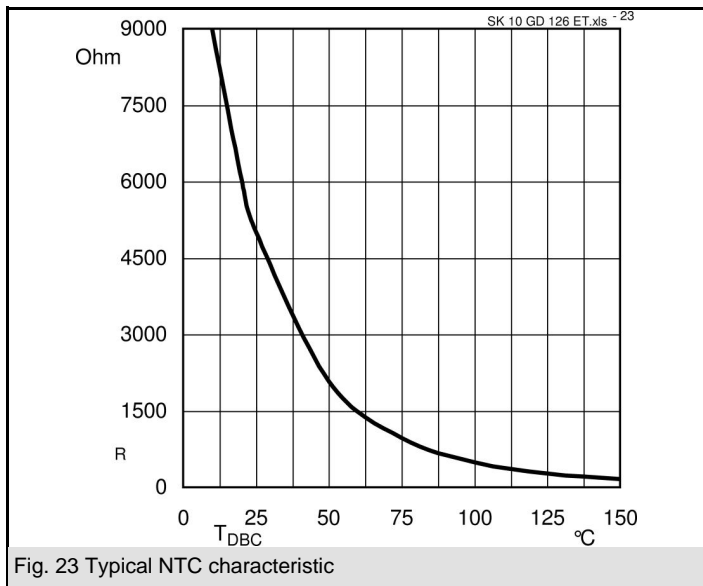
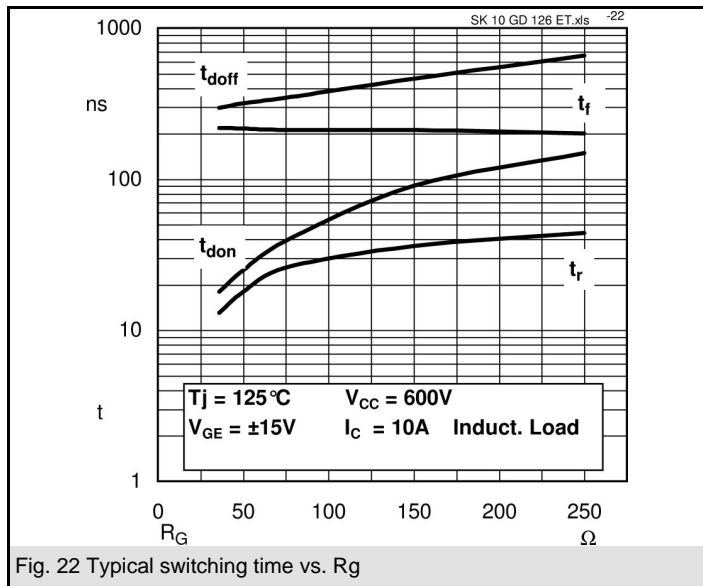
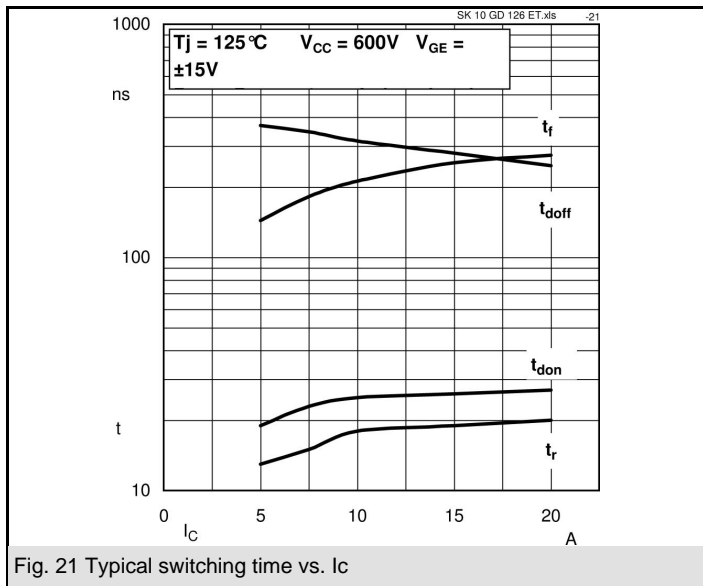

Fig. 19 Typical gate charge characteristic



# SK 10 GD 126 ET

UL Recognized  
File no. E63 532

Dimensions in mm

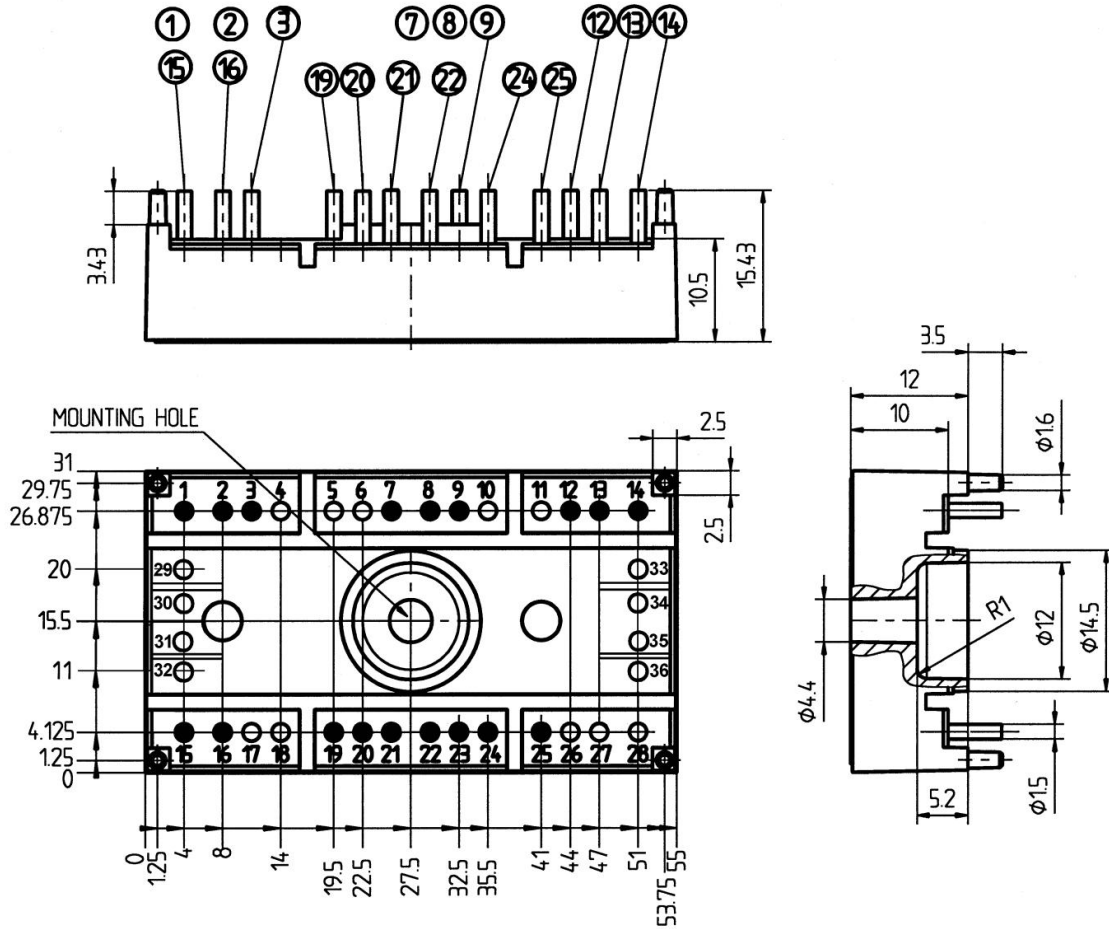

Case T 52 (Suggested hole diameter, in the PCB, for solder pins and plastic mounting pins: 2mm)

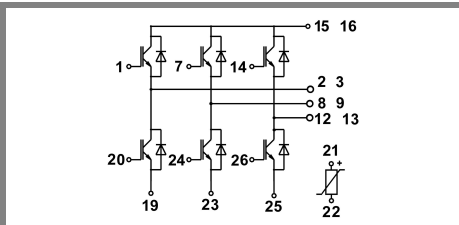

Case T 52

This is an electrostatic discharge sensitive device (ESDS), international standard IEC 60747-1, Chapter IX.

This technical information specifies semiconductor devices but promises no characteristics. No warranty or guarantee expressed or implied is made regarding delivery, performance or suitability.