

Features

- Plastic package has Underwriters Laboratory Flammability Classification 94V-0
- Metal silicon junction, majority carrier conduction
- Guardring for overvoltage protection
- Low power loss, high efficiency
- High current capability, low forward voltage drop
- High surge capability
- For use in low voltage, high frequency inverters, free wheeling, and polarity protection applications
- High temperature soldering guaranteed: 250°C/10 seconds, 2.8mm lead length

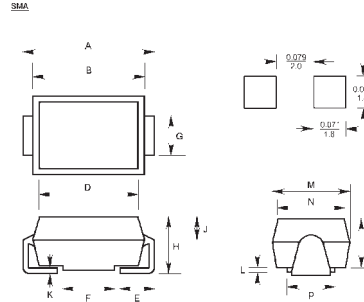

Mechanical Data

- **Case:** SMA molded plastic body
- **Polarity:** Color band denotes cathode end
- **Mounting Position:** Any
- **Weight:** 0.004 ounce, 0.11 gram

DIM	DIMENSIONS				Note
	Inches		mm		
A	0.216	0.226	5.48	5.74	
B	0.176	0.182	4.48	4.63	
C	0.094	0.100	2.40	2.55	
D	0.170	0.176	4.33	4.48	
E	0.039	0.055	1.00	1.40	
F	0.060	0.081	2.03	2.07	
G	0.068	0.083	1.72	2.10	
H	0.112	0.118	2.85	3.00	
J	0.057	-	1.44	-	
K	-	0.018	-	0.45	
L	0.016	-	0.40	-	
M	0.109	0.115	2.77	2.93	
N	0.105	0.107	2.67	2.73	
P	0.078	0.081	2.00	2.05	

Maximum Ratings and Electrical Characteristics

Ratings at 25°C ambient temperature unless otherwise specified.

	Symbols	SKN7	SKN8	SKN9	Units
Maximum repetitive peak reverse voltage	V_{RRM}	20	30	40	Volts
Maximum RMS voltage	V_{RMS}	14	21	28	Volts
Maximum DC blocking voltage	V_{DC}	20	30	40	Volts
Maximum non-repetitive peak reverse voltage	V_{RSM}	24	36	48	Volts
Maximum average forward rectified current 2.8mm lead length at $T_L=90^\circ\text{C}$	$I_{(AV)}$	1.0			Amp
Peak forward surge current, 8.3ms single half sine-wave superimposed on rated load (MIL-STD-750D 4066 method) at $T_L=70^\circ\text{C}$	I_{FSM}	25.0			Amps
Maximum instantaneous forward voltage at 1.0A (Note 1) Maximum instantaneous forward voltage at 3.1A (Note 1)	V_F V_F	0.450 0.750	0.550 0.875	0.600 0.900	Volts Volts
Maximum instantaneous reverse current at rated DC blocking voltage $T_A=25^\circ\text{C}$ $T_A=110^\circ\text{C}$	I_R	1.0 10.0			mA
Typical junction capacitance (Note 3)	C_J	110.0			pF
Typical thermal resistance (Note 2)	$R_{\theta JA}$ $R_{\theta JL}$	50.0 15.0			°C/W
Operating junction and storage temperature range	T_J, T_{STG}	-65 to +125			°C

Notes:

- (1) Pulse test: 300uS pulse width, 1% duty cycle
- (2) Thermal resistance from junction to lead, and/or to ambient P.C.B. mounted with 2.8mm lead length with 1.5X1.5" (38X38mm) copper pads
- (3) Measured at 1.0MHz and applied reverse voltage of 4.0 volts

RATINGS AND CHARACTERISTIC CURVES

SKN7

Figure 1
Typical Forward Characteristics

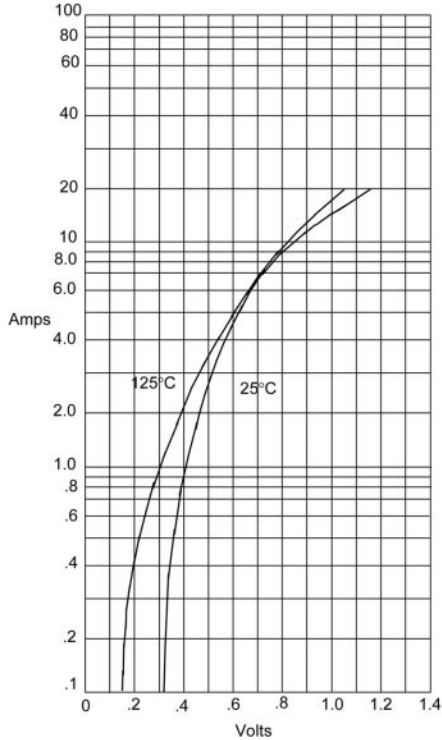

Instantaneous Forward Current - Amperes versus
Instantaneous Forward Voltage - Volts

Figure 2
Typical Reverse Characteristics

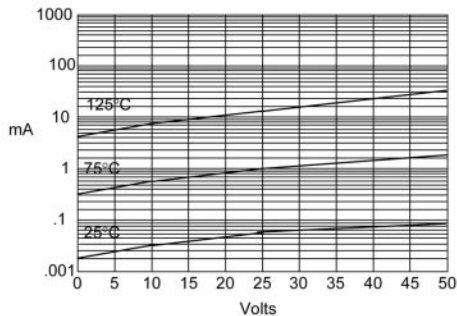

Typical Reverse Current - mA versus
Reverse Voltage - Volts

Figure 3
Typical Junction Capacitance

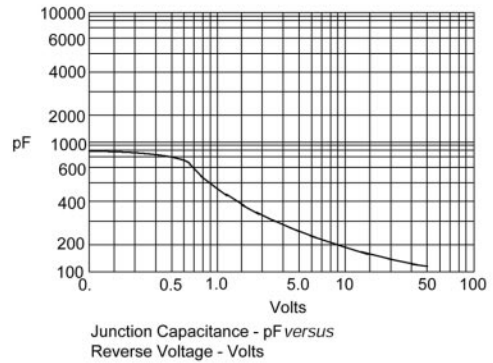

Junction Capacitance - pF versus
Reverse Voltage - Volts

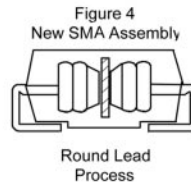

RATINGS AND CHARACTERISTIC CURVES

Figure 1
Typical Forward Characteristics

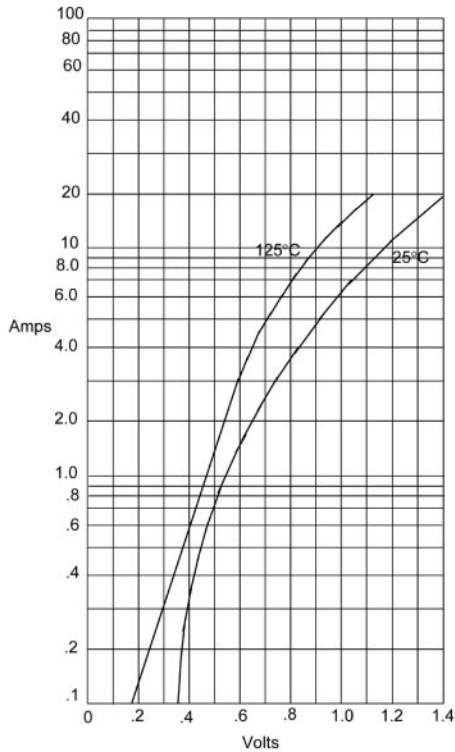

Instantaneous Forward Current - Amperes versus
Instantaneous Forward Voltage - Volts

Figure 2
Typical Reverse Characteristics

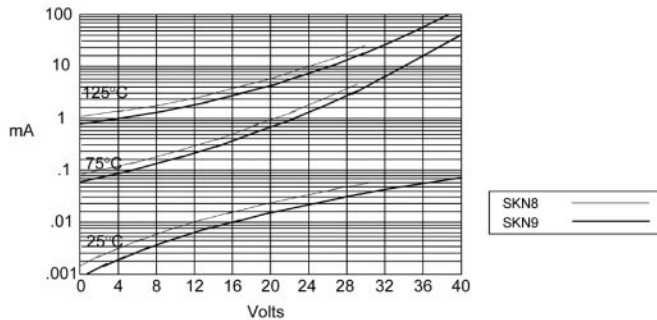

Typical Reverse Current - mA versus
Reverse Voltage - Volts

Figure 3
Typical Junction Capacitance

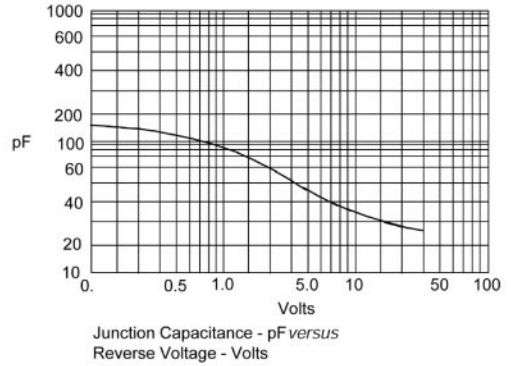

Junction Capacitance - pF versus
Reverse Voltage - Volts

