

Description

The SL71063 is a voltage and current control IC which contains precision voltage reference. It is suitable for battery charger, second controller of switching regulator systems, and other battery systems.

Features

- Constant Voltage & Constant Current Control
- Wide input voltage range : 2.2V to 14V
- Internal Precision Voltage Reference : 1.240V \pm 1%
- Photo Coupler (PC) Drive Current : 40mA Typ.
- Operating Current : 1mA Max.
- Easy compensation & Low external component count.
- Package Outline : SOT26.

Applications

- Adapters
- Battery chargers

Ordering Information

Type NO.	Marking	Package Code
SL71063	763	SOT - 26

Outline Dimensions

unit : mm

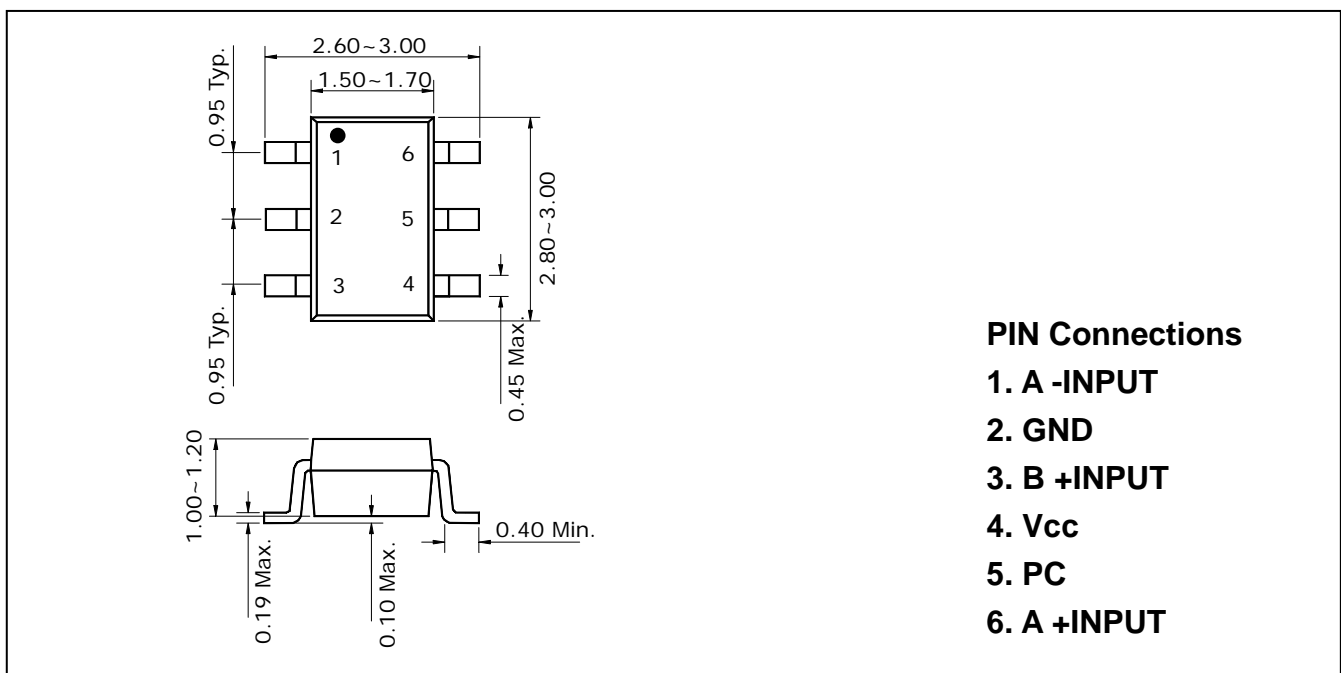

Internal Block Diagram

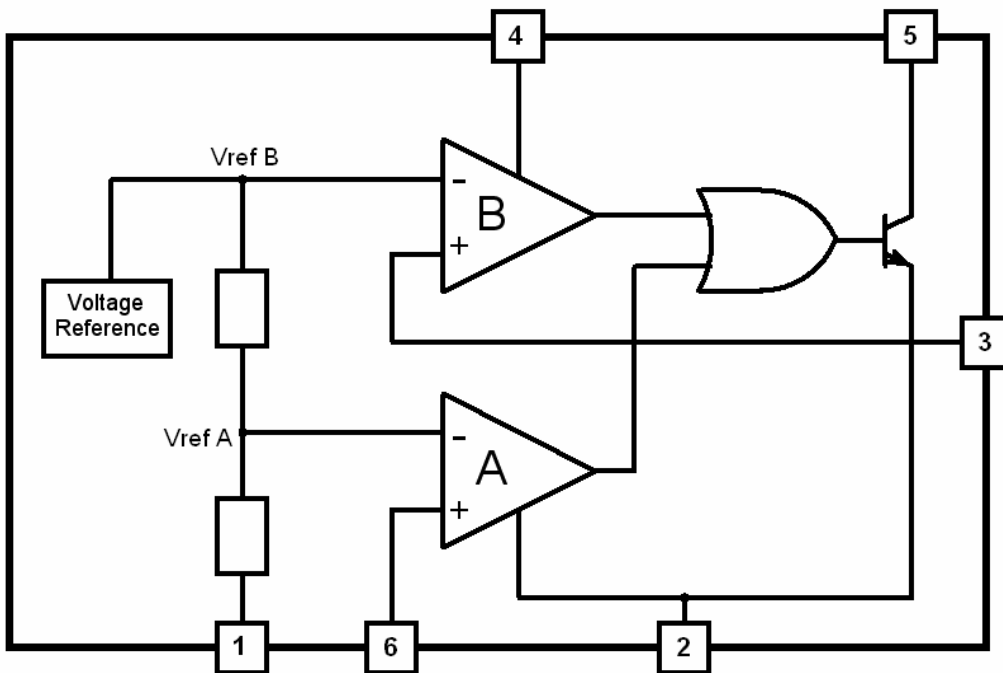

Typical Application : Adapter or Battery Charger Application Using SL71063

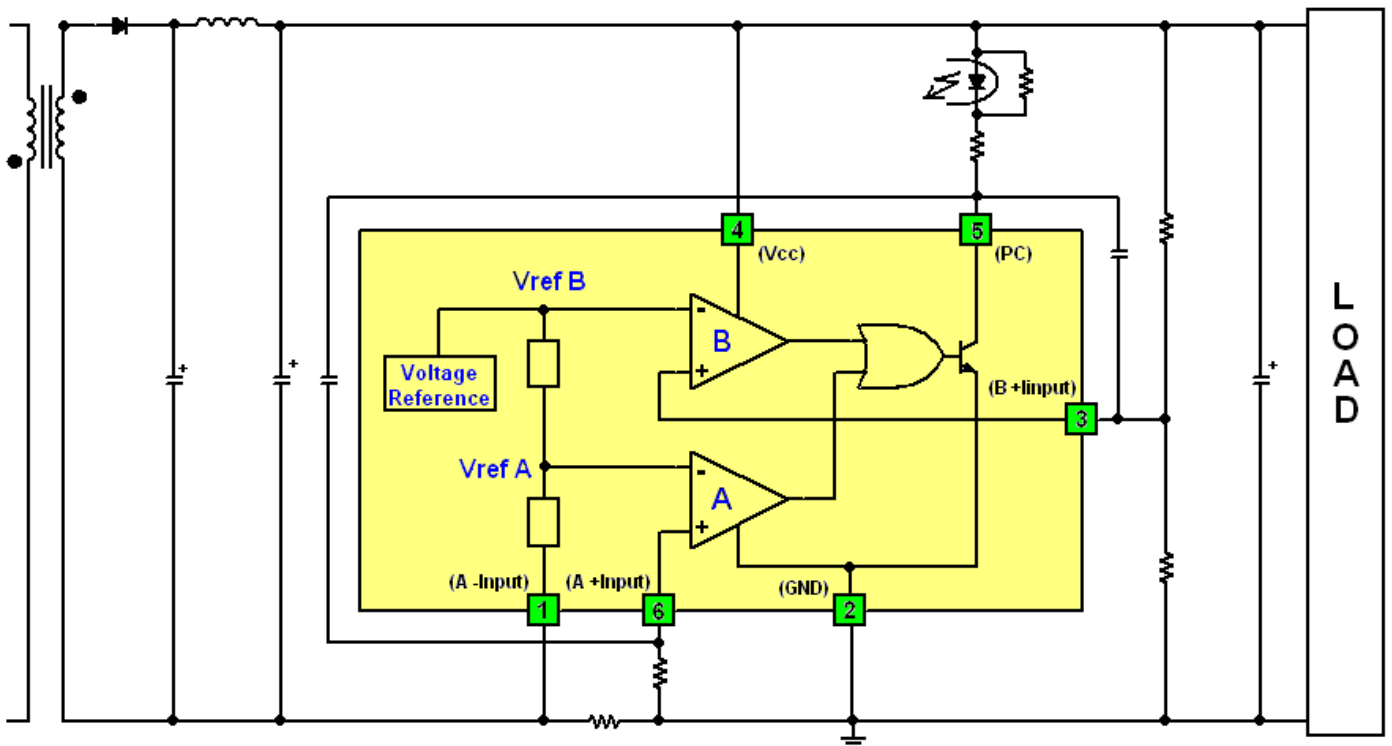

In the above application schematic, the SL71063 is used on the secondary side of a flyback adapter (or battery charger) to provide an accurate control of voltage and current.

The above feedback loop is made with an optocoupler.

Pin Description

Name	Pin No.	Function
A -INPUT	1	Input Pin of the Current Control Loop
GND	2	Ground Line. 0V Reference For All Voltages
B +INPUT	3	Input Pin of the Voltage Control Loop
Vcc	4	DC Supply Line
PC	5	Photo Coupler (P/C)Drive Pin. Sinking Current Only
A +INPUT	6	Input Pin of the Current Control Loop

Absolute Maximum Ratings

Characteristic	Symbol	Value	Unit
DC Supply Voltage	Vcc	16	V
Power Dissipation	Pd *	500	mW
Operating Ambient Temperature Range	Topr	-40 to 85	°C
Storage Temperature Range	Tstg	-55 to 150	°C

* Mount on a glass epoxy circuit board of 30x30mm Pad dimension of 50mm²

Operating Conditions

Characteristic	Symbol	Value	Unit
DC Supply Voltage	V _{CC}	2.2 to 14	V

Electrical Characteristics

T_a = 25°C and V_{CC} = 5V (unless otherwise specified)

Characteristic	Symbol	Test Condition	Min.	Typ.	Max.	Unit
Operating Current	I _{CC}	I _{PC} = off	-	0.6	1.0	mA
Leakage Current	I _{PCLEAK}	V ⁺ = V _{PC} = 14V	-	-	10	μA
Saturation Voltage	V _{PCSAT}	I _{PC} = 20 mA	-	500	700	mV
PC Terminal Current	I _{PC}	-	20	40	70	mA
Output Voltage High	V _{OH}	R _L = 30 kΩ	-	V _{CC} - 0.1	-	V

Electrical Characteristics (Continued)

Ta = 25°C and V_{CC} = 5V (unless otherwise specified)

Characteristic	Symbol	Test Condition	Min.	Typ.	Max.	Unit
[A CH : Current Control Loop]						
Reference Voltage ¹⁾	V _{REF(A)}	I _{PC} = 2.5 mA	69	72	75	mV
Input Bias Current	I _{B(A)}	-	-	20	50	μA
Transconduction Gain ²⁾	G _{M(A)}	-	1.5	8	-	mA/mV
[B Ch : Voltage Control Loop]						
Reference Voltage ³⁾	V _{REF(B)}	I _{PC} = 1.5 mA	1.227	1.240	1.253	V
Input Bias Current	I _{B(B)}	-	-	50	500	nA
Transconduction Gain ⁴⁾	G _{M(B)}	-	1	3	-	mA/mV

- 1) The internal current sense threshold is set to -72mV. The current control loop precision takes into account the cumulative effects of the internal voltage reference deviation as well as the input offset voltage of the trans-conduction operational amplifier.
- 2) When the positive input at ICTRL is lower than -72mV, and the voltage is decreased by 1mV, the sinking current at the output OUT will be increased by 8mA.
- 3) The internal voltage reference is set at 1.240V (bandgap reference). The voltage control loop precision takes into account the cumulative effects of the internal voltage reference deviation as well as the input offset voltage of the trans-conductance operational amplifier.
- 4) If the voltage on B +Input (the positive input of the amplifier) is higher than the negative amplifier input (V_{ref(B)} = 1.240V), and it is increased by 1mV, the sinking current at the output OUT will be increased by 3mA.

Fig.1 Supply current vs Ambient Temperature

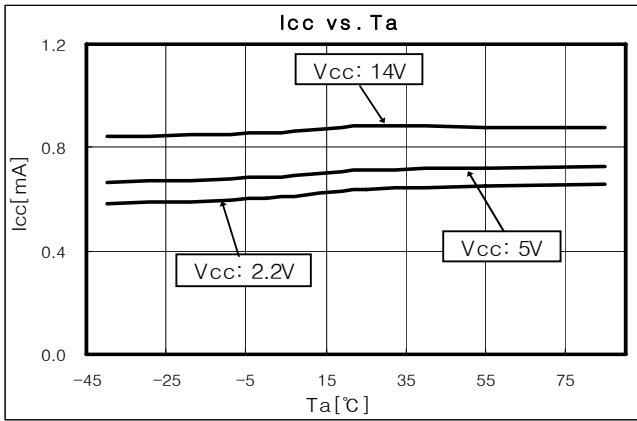

Fig.2 Vref(B) vs Ambient Temperature

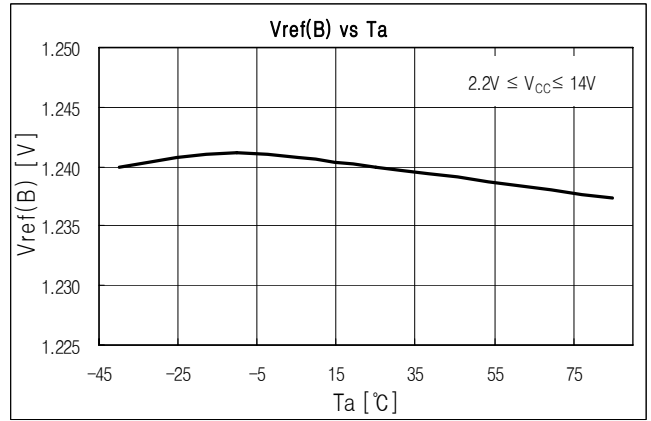

Fig.3 Vref(A) vs Ambient Temperature

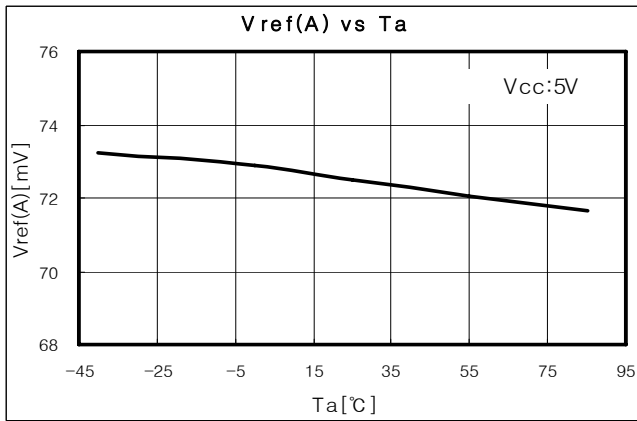

Fig.4 Saturation Voltage vs Ambient Temperature

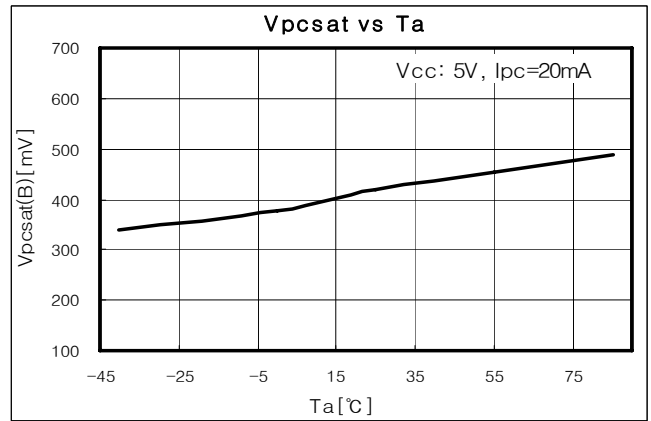
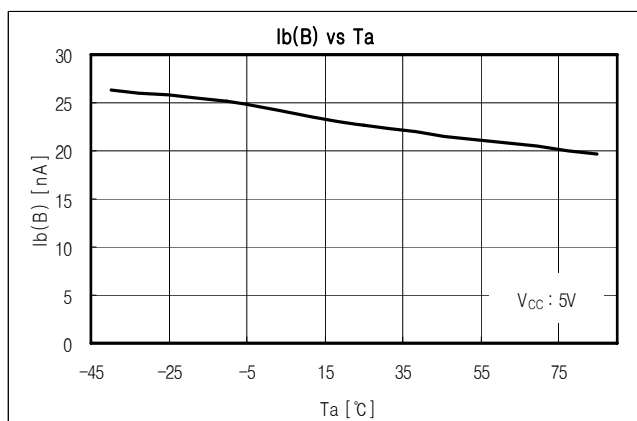

Fig. 5 Input Bias Current vs Ambient Temperature



The AUK Corp. products are intended for the use as components in general electronic equipment (Office and communication equipment, measuring equipment, home appliance, etc.).

Please make sure that you consult with us before you use these AUK Corp. products in equipments which require high quality and / or reliability, and in equipments which could have major impact to the welfare of human life(atomic energy control, airplane, spaceship, transportation, combustion control, all types of safety device, etc.). AUK Corp. cannot accept liability to any damage which may occur in case these AUK Corp. products were used in the mentioned equipments without prior consultation with AUK Corp..

Specifications mentioned in this publication are subject to change without notice.