

SM2G50US60

FEATURES

- High Speed Switching
- Low Conduction Loss
: $V_{CE(sat)} = 2.1 \text{ V (typ)}$
- Fast & Soft Anti-Parallel FWD
- Short circuit rated
: Min 10uS at $T_c = 100^\circ\text{C}$

APPLICATIONS

- General Purpose Inverters
- Welding Machine
- Induction Heating
- UPS , CVCF
- Robotics , Servo Controls

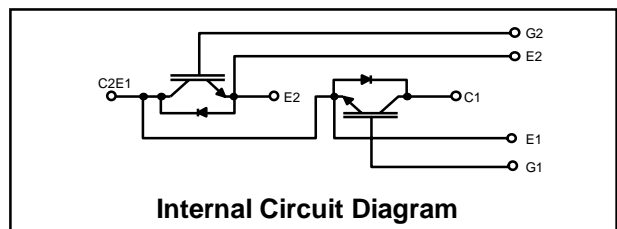
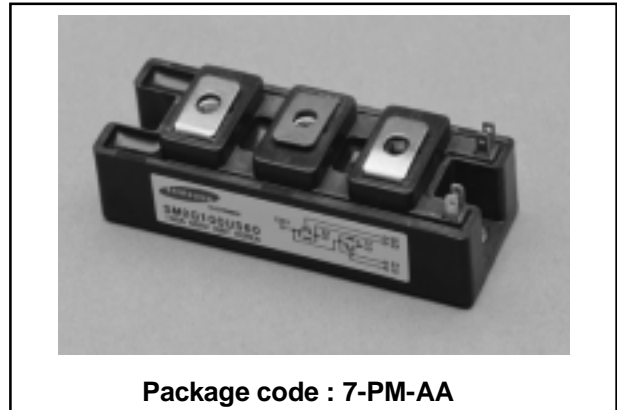

ABSOLUTE MAXIMUM RATINGS ($T_c = 25^\circ\text{C}$)

Symbol	Characteristics	Rating	Units
V_{CES}	Collector-Emitter Voltage	600	V
V_{GES}	Gate-Emitter Voltage	± 20	V
I_C	Collector Current @ $T_c = 25^\circ\text{C}$	50	A
$I_{CM(1)}$	Pulsed Collector Current	100	A
I_F	Diode Continuous Forward Current @ $T_c = 25^\circ\text{C}$	50	A
I_{FM}	Diode Maximum Forward Current	100	A
P_C	Maximum Power Dissipation @ $T_c = 25^\circ\text{C}$	250	W
T_j	Operating Junction Temperature	-40 ~ 150	$^\circ\text{C}$
T_{stg}	Storage Temperature Range	-40 ~ 125	$^\circ\text{C}$
Viso	Isolation Voltage @ AC 1 min	2500	V
	Mounting Torque @ Power terminals screw :M5	2.0	N.m
	Mounting screw :M5	2.0	N.m

Notes: (1) Repetitive Rating : Pulse width Limited by Max.Junction Temperature

SM2G50US60

ELECTRICAL CHARACTERISTICS (IGBT PART)

(T_c=25 °C, Unless Otherwise Specified)

Symbol	Characteristics	Test Conditions	Min	Typ	Max	Units
BV _{CES}	C - E Breakdown Voltage	V _{GE} = 0V , I _C = 250μA	600	-	-	V
ΔV _{CES} / ΔT _J	Temperature Coeff. of Breakdown Voltage	V _{GE} = 0V , I _C = 1mA	-	0.6	-	V/°C
V _{GE(th)}	G - E threshold voltage	I _C = 50mA , V _{CE} = V _{GE}	5	6	8.5	V
I _{CES}	Collector cutoff Current	V _{CE} = V _{CES} , V _{GE} = 0V	-	-	250	uA
I _{GES}	G - E leakage Current	V _{GE} = V _{GES} , V _{CE} = 0V	-	-	100	nA
V _{CE(sat)}	Collector to Emitter saturation voltage	I _C =50A, V _{GE} = 15V @T _C = 25°C	-	2.1	2.7	V
		I _C =50A, V _{GE} = 15V @T _C =100°C	-	2.7	-	V
C _{ies}	Input capacitance	V _{GE} = 0V , f = 1MHz V _{CE} = 30V	-	4200	-	pF
C _{oes}	Output capacitance		-	400	-	pF
C _{res}	Reverse transfer capacitance		-	120	-	pF
td(on)	Turn on delay time	V _{CC} = 300V , I _C = 50A V _{GE} = 15V R _G = 13 Ω Inductive Load	-	90	-	ns
tr	Turn on rise time		-	65	-	ns
td(off)	Turn off delay time		-	184	-	ns
tf	Turn off fall time		-	80	250	ns
E _{on}	Turn on Switching Loss		-	1.5	-	mJ
E _{off}	Turn off Switching Loss		-	0.9	-	mJ
E _{ts}	Total Switching Loss		-	2.4	4.8	mJ
T _{sc}	Short Circuit withstand Time	V _{CC} = 300V, V _{GE} = 15V @T _C = 100°C	10	-	-	uS
Q _g	Total Gate Charge	V _{CC} = 300V V _{GE} = 15V I _C = 50A	-	220	330	nC
Q _{ge}	Gate-Emitter Charge		-	50	-	nC
Q _{gc}	Gate-Collector Charge		-	90	-	nC

SM2G50US60

ELECTRICAL CHARACTERISTICS (DIODE PART)

(T_c=25 °C, Unless Otherwise Specified)

Symbol	Characteristics	Test Conditions	Min	Typ	Max	Units	
V _{FM}	Diode Forward Voltage	I _F =50A	T _c =25 °C	-	1.9	2.8	V
			T _c =100 °C	-	1.8	-	
T _{rr}	Diode Reverse	I _F =50A, V _R =200V di/dt= -100A/uS	T _c =25 °C	-	90	130	nS
	Recovery Time		T _c =100 °C	-	130	-	
I _{rr}	Diode Peak Reverse		T _c =25 °C	-	5	6.5	A
	Recovery Current		T _c =100 °C	-	7	-	
Q _{rr}	Diode Reverse	T _c =25 °C	-	225	422	nC	
	Recovery Charge	T _c =100 °C	-	455	-		

THERMAL RESISTANCE

Symbol	Characteristics	Typ	Max	Units
R _θ JC	Junction-to-Case(IGBT Part, Per 1/2 Module)	-	0.5	°C/W
R _θ JC	Junction-to-Case(DIODE Part, Per 1/2 Module)	-	1.0	°C/W
R _θ CS	Case-to-Sink (Conductive grease applied)	-	0.15	°C/W
Weight	Weight of Module	-	190	°C/W

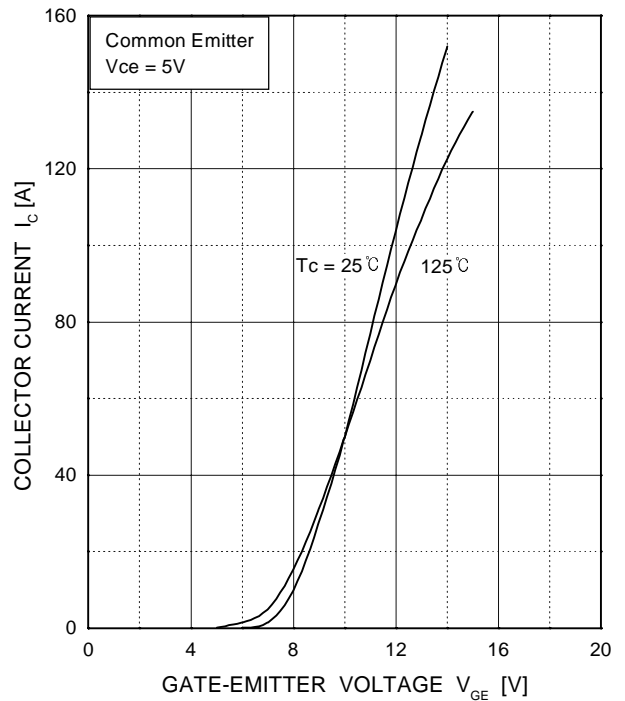
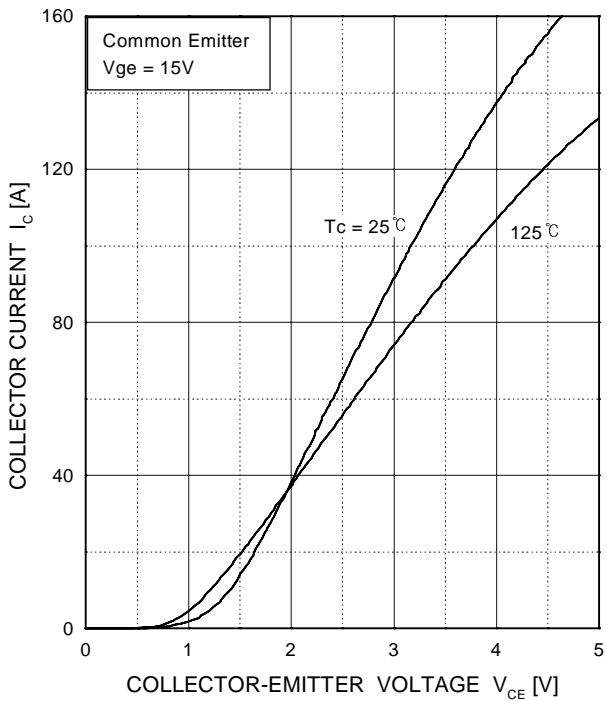
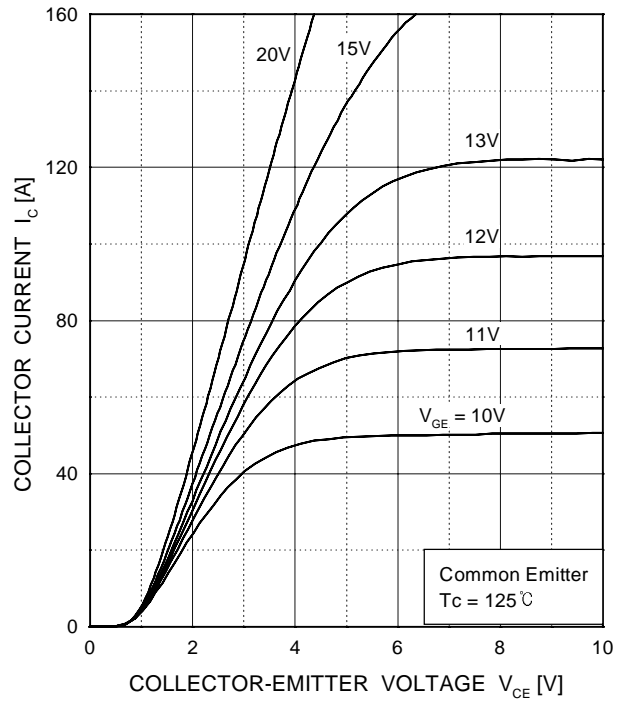
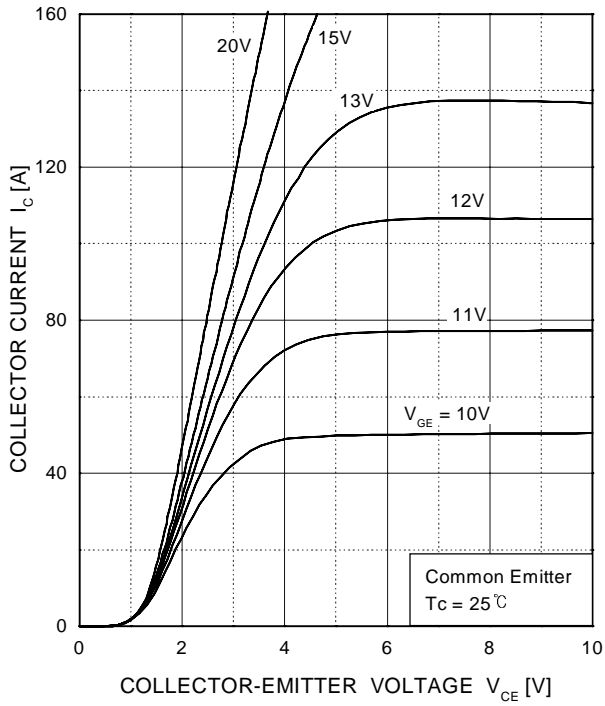

SM2G50US60

Preliminary IGBT MODULE

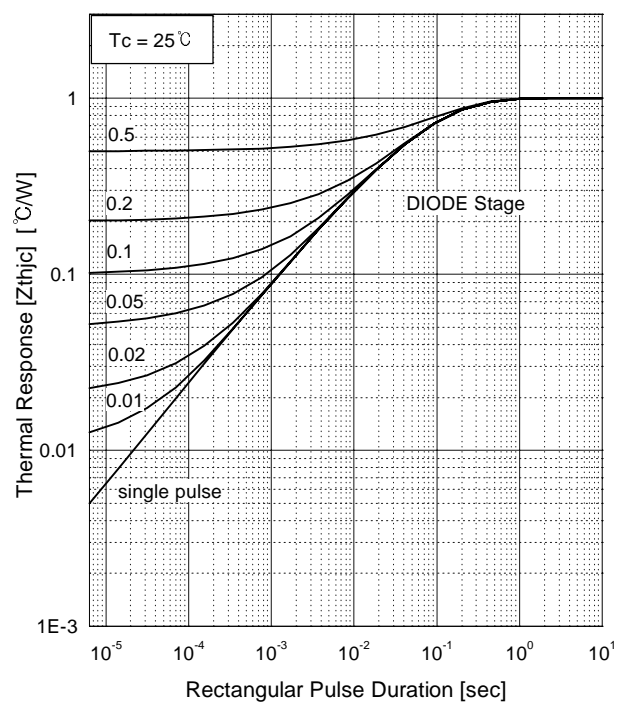
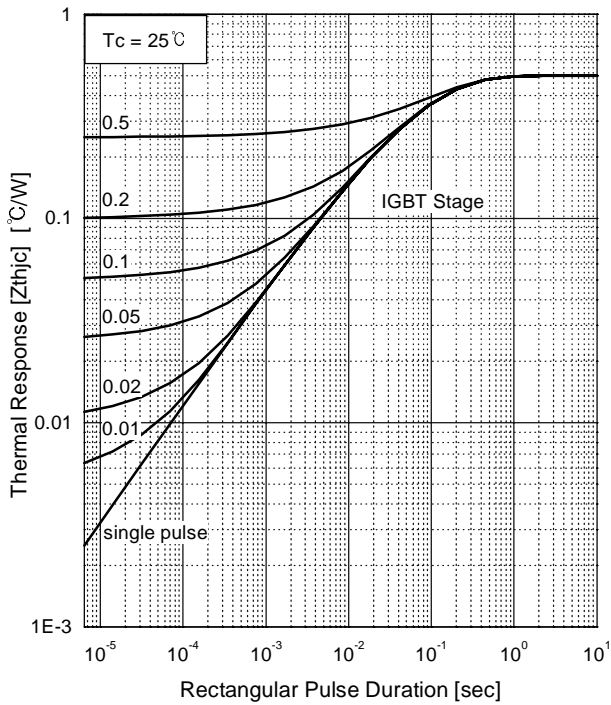
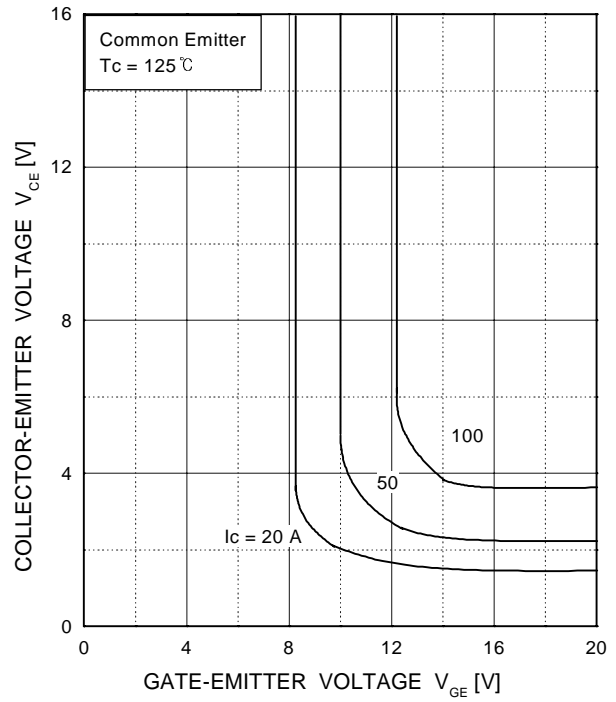
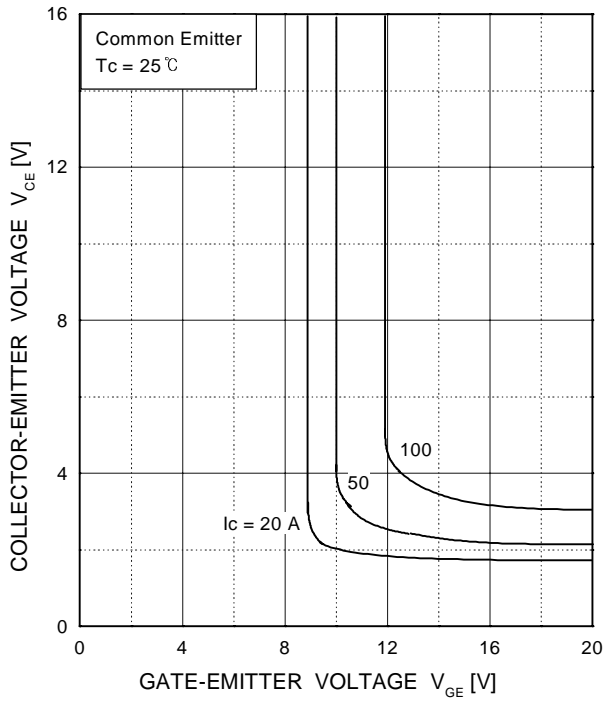

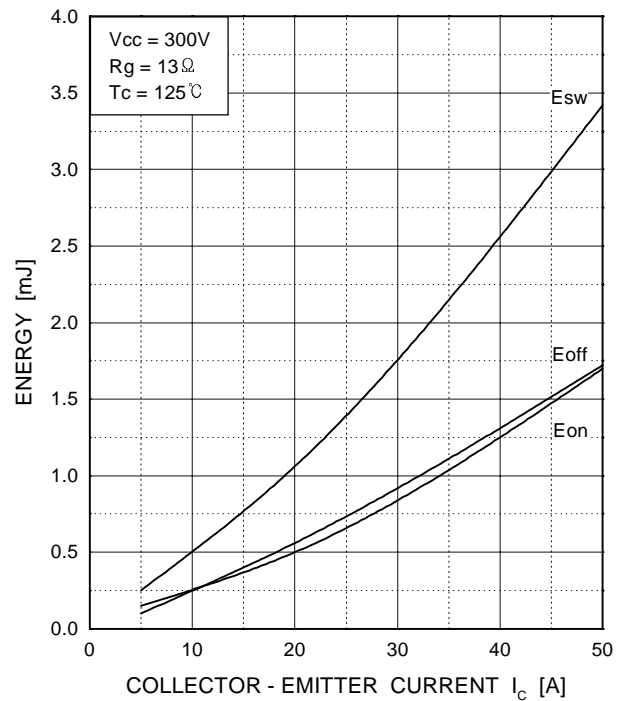
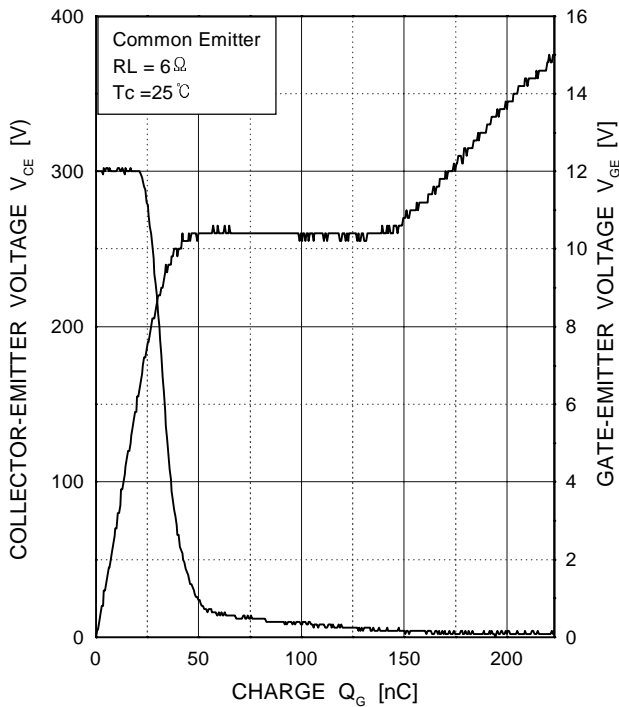
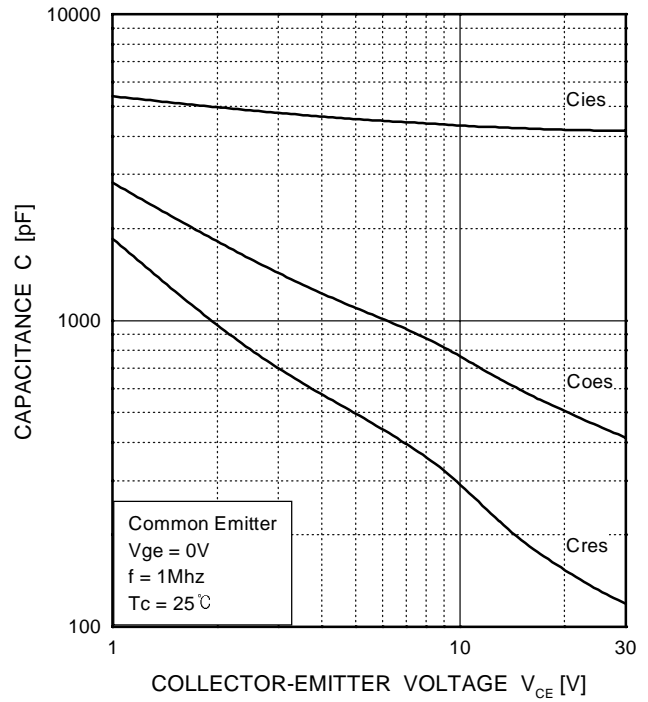
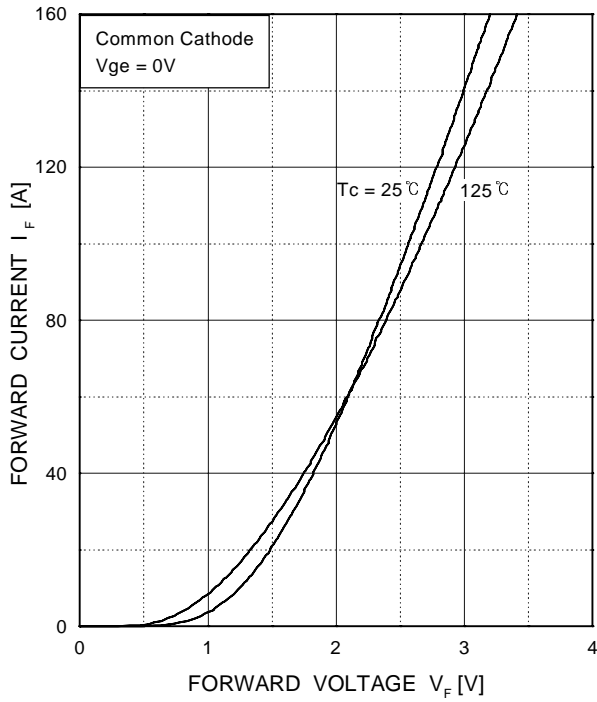

SM2G50US60

Preliminary
IGBT MODULE

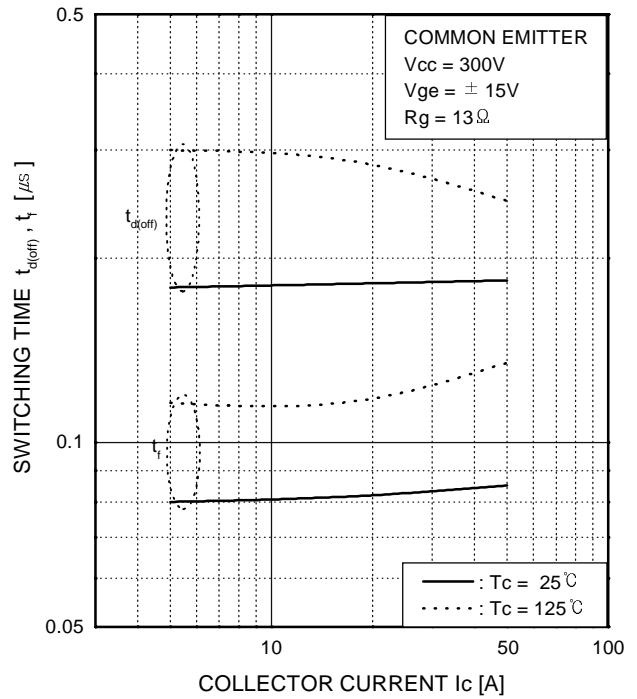
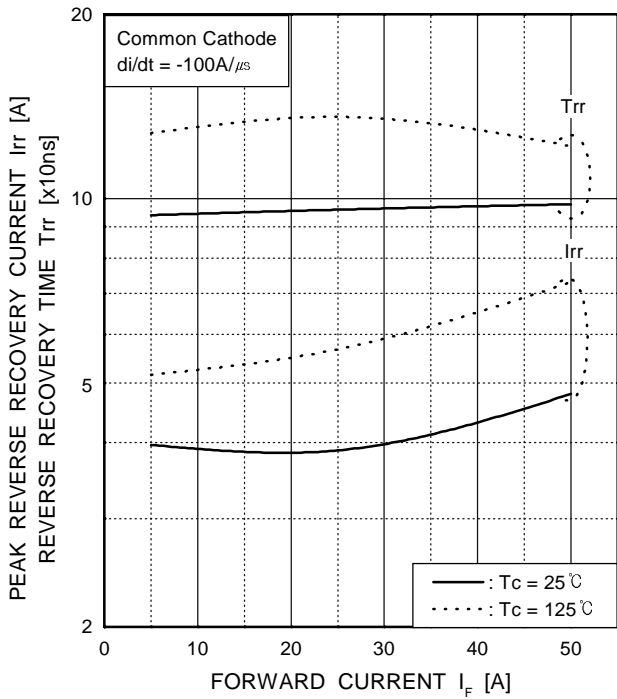
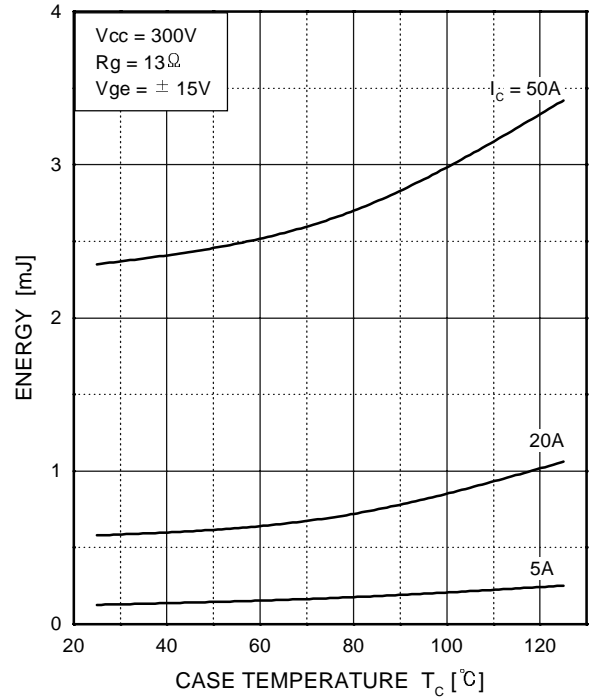
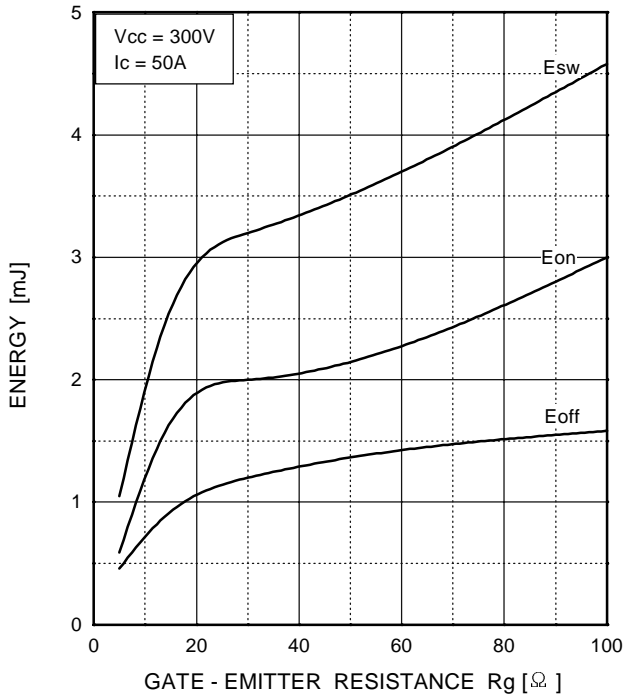

SM2G50US60

Preliminary
IGBT MODULE

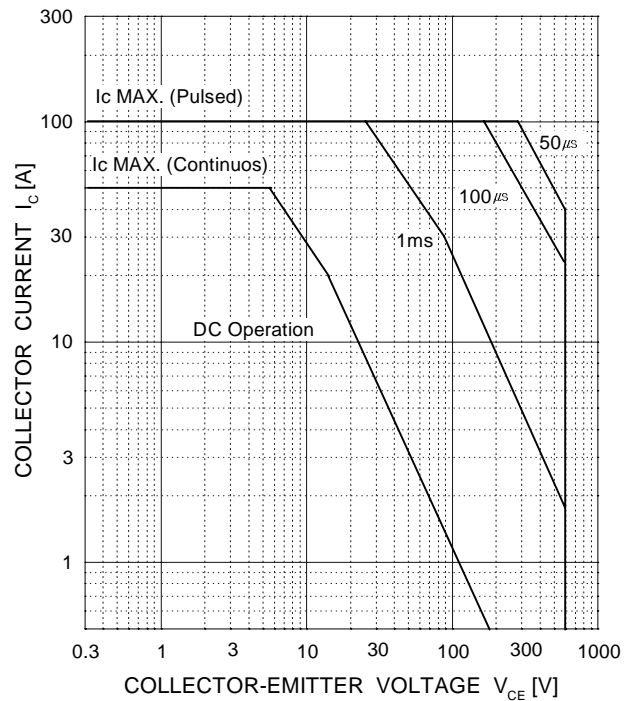
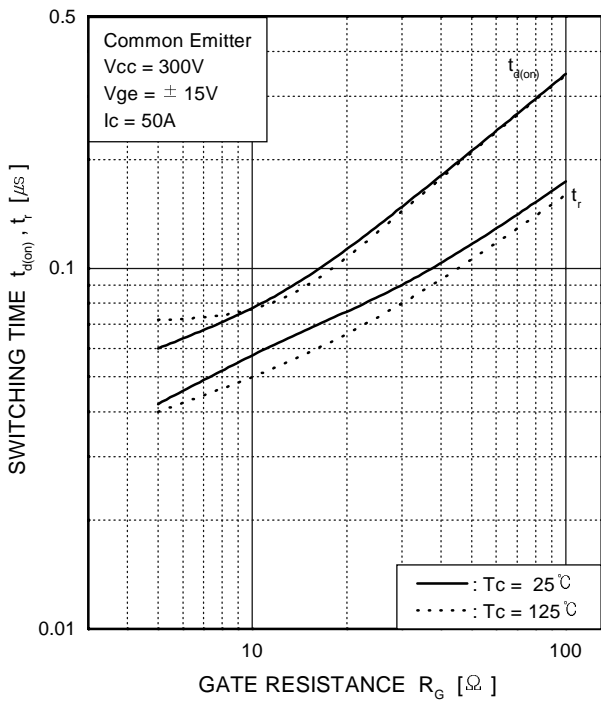
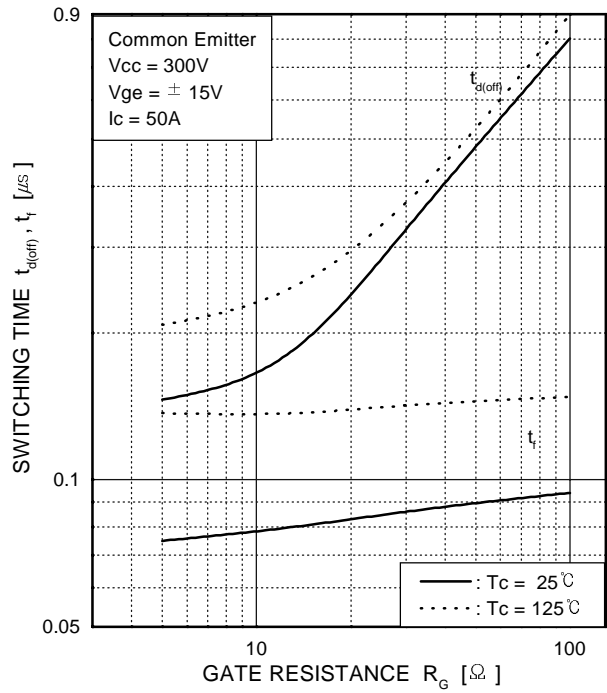
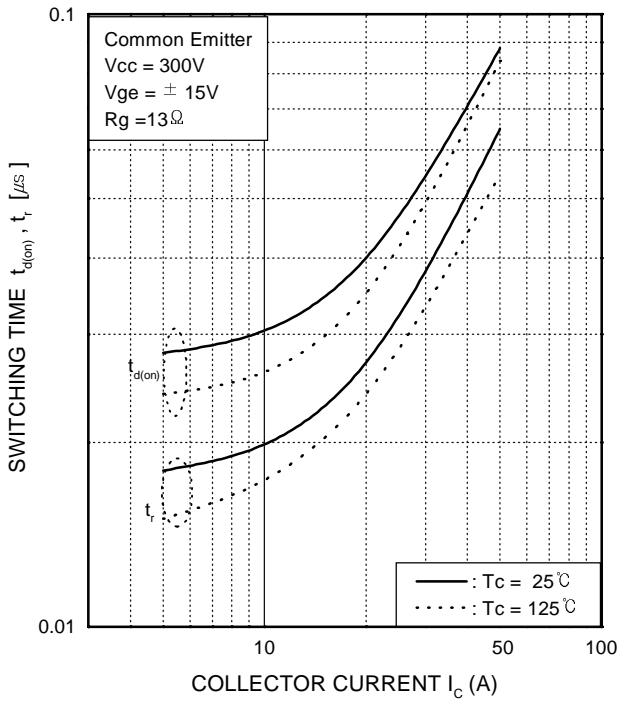

SM2G50US60

Preliminary
IGBT MODULE

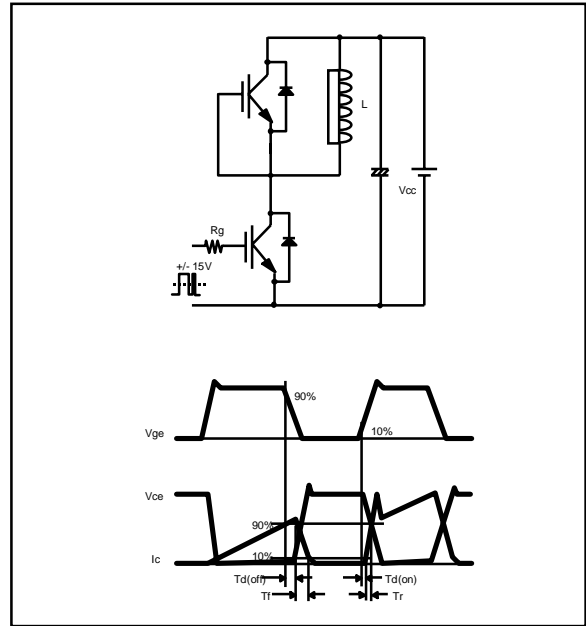
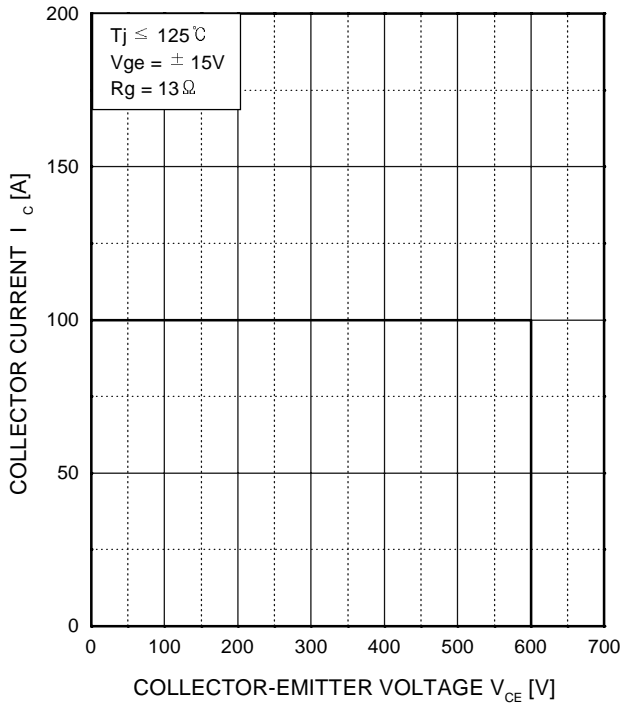

Inductive Load Test Circuit and Waveforms

7-PM-AA

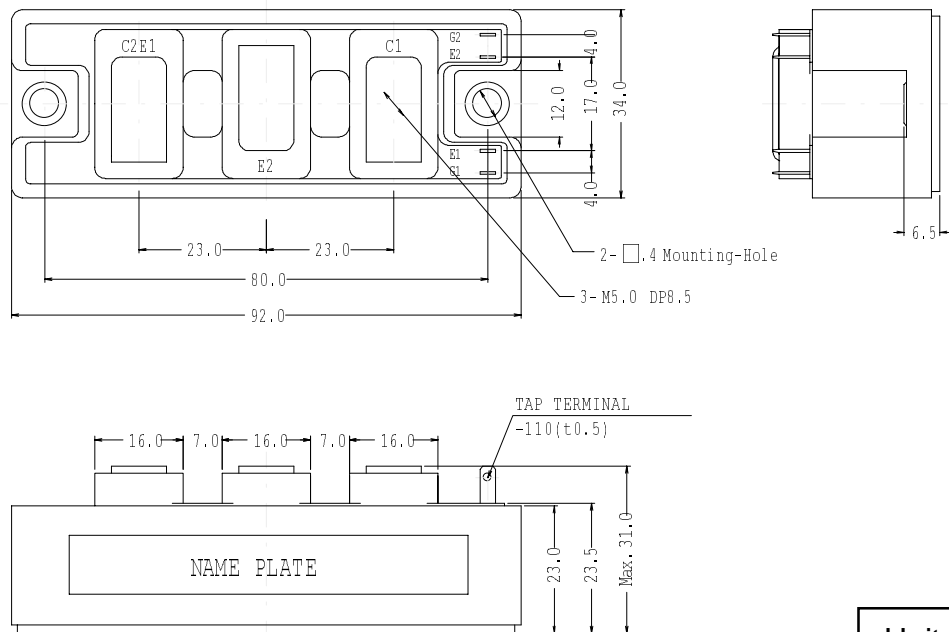

Unit : mm

TRADEMARKS

The following are registered and unregistered trademarks Fairchild Semiconductor owns or is authorized to use and is not intended to be an exhaustive list of all such trademarks.

ACEX™
CoolFET™
CROSSVOLT™
E2CMOS™
FACT™
FACT Quiet Series™
FAST®
FASTr™
GTO™
HiSeC™

ISOPLANAR™
MICROWIRE™
POP™
PowerTrench™
QS™
QuietSeries™
SuperSOT™.3
SuperSOT™.6
SuperSOT™.8
TinyLogic™

DISCLAIMER

FAIRCHILD SEMICONDUCTOR RESERVES THE RIGHT TO MAKE CHANGES WITHOUT FURTHER NOTICE TO ANY PRODUCTS HEREIN TO IMPROVE RELIABILITY, FUNCTION OR DESIGN. FAIRCHILD DOES NOT ASSUME ANY LIABILITY ARISING OUT OF THE APPLICATION OR USE OF ANY PRODUCT OR CIRCUIT DESCRIBED HEREIN; NEITHER DOES IT CONVEY ANY LICENSE UNDER ITS PATENT RIGHTS, NOR THE RIGHTS OF OTHERS.

LIFE SUPPORT POLICY

FAIRCHILD'S PRODUCTS ARE NOT AUTHORIZED FOR USE AS CRITICAL COMPONENTS IN LIFE SUPPORT DEVICES OR SYSTEMS WITHOUT THE EXPRESS WRITTEN APPROVAL OF FAIRCHILD SEMICONDUCTOR CORPORATION.

As used herein:

1. Life support devices or systems are devices or systems which, (a) are intended for surgical implant into the body, or (b) support or sustain life, or © whose failure to perform when properly used in accordance with instructions for use provided in the labeling, can be reasonably expected to result in significant injury to the user.

2. A critical component is any component of a life support device or system whose failure to perform can be reasonably expected to cause the failure of the life support device or system, or to affect its safety or effectiveness.

LIFE SUPPORT POLICY

Definition of Terms

Datasheet Identification	Product Status	Definition
Advance Information	Formative or In Design	This datasheet contains the design specifications for product development. Specifications may change in any manner without notice.
Preliminary	First Production	This datasheet contains preliminary data, and supplementary data will be published at a later date. Fairchild Semiconductor reserves the right to make changes at any time without notices in order to improve design.
No Identification Needed	Full Production	This datasheet contains final specifications. Fairchild Semiconductor reserves the right to make changes at any time without notice in order to improve design.
Obsolete	Not In Production	This datasheet contains specifications on a product that has been discontinued by Fairchild semiconductor. The datasheet is printed for reference information only.