

Product Description

Sirenza Microdevices' SPA-1318 is a high efficiency GaAs Heterojunction Bipolar Transistor (HBT) amplifier housed in a low-cost surface-mountable plastic package. These HBT amplifiers are fabricated using molecular beam epitaxial growth technology which produces reliable and consistent performance from wafer to wafer and lot to lot.

This product is specifically designed for use as a driver amplifier for infrastructure equipment in the 2150 MHz PCS band. Its high linearity makes it an ideal choice for multi-carrier and digital applications.

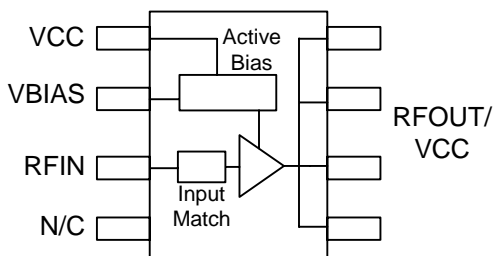

SPA-1318

2150 MHz 1 Watt Power Amplifier with Active Bias



Product Features

- **High Linearity Performance:**
 - +20.1 dBm W-CDMA Channel Power at -50 dBc ACP
 - +47 dBm Typ. OIP3
- **On-chip Active Bias Control**
- **Power Control Allows Power Consumption Reduction**
- **Patented High Reliability GaAsHBT Technology**
- **Surface-Mountable Plastic Package**

Applications

- **W-CDMA Systems**
- **Multi-Carrier Applications**

Symbol	Parameters: Test Conditions: $Z_0 = 50 \text{ Ohms}$, Temp = 25°C, $V_{cc} = 5.0\text{V}$	Units	Min.	Typ.	Max.
f_0	Frequency of Operation	MHz	2110		2170
P_{1dB}	Output Power at 1dB Compression ^[1,2]	dBm		29.0	
ACP	Adjacent Channel Power ^[1] W-CDMA @ $P_{OUT} = 20.1 \text{ dBm}$	dBc		-50.0	-47.0
S_{21}	Small Signal Gain ^[1,2]	dB	11.5	12.5	13.5
VSWR	Input VSWR ^[1,2]	-		1.5:1	
OIP ₃	Output Third Order Intercept Point ^[2] Power out per tone = +14dBm	dBm		47.0	
NF	Noise Figure ^[1,2]	dB		7.0	
I _{cc}	Device Current ^[1,2]	mA	275	310	330
V _{cc}	Device Voltage ^[1,2]	V	4.75	5.0	5.25
R_{thj-l}	Thermal Resistance (junction - lead), $T_L=85^\circ\text{C}$	°C/W		35	

[1] Optimal ACP tune

[2] Optimal IP3 tune

The information provided herein is believed to be reliable at press time. Sirenza Microdevices assumes no responsibility for inaccuracies or omissions. Sirenza Microdevices assumes no responsibility for the use of this information, and all such information shall be entirely at the user's own risk. Prices and specifications are subject to change without notice. No patent rights or licenses to any of the circuits described herein are implied or granted to any third party. Sirenza Microdevices does not authorize or warrant any Sirenza Microdevices product for use in life-support devices and/or systems. Copyright 2002 Sirenza Microdevices, Inc. All worldwide rights reserved.

2110-2170 MHz Application Circuit Data, I_{cc}=320mA, V_{cc}=5V

Note: Tuned for ACP

W-CDMA @ 2.14GHz

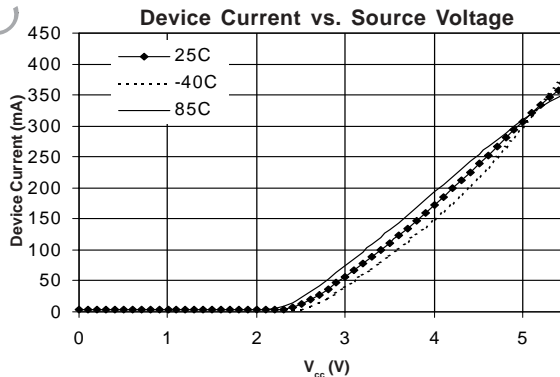
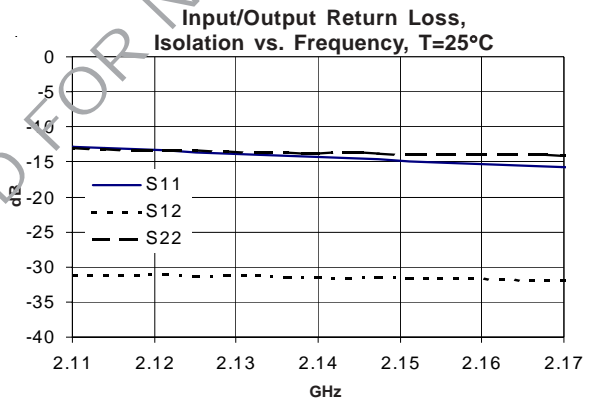
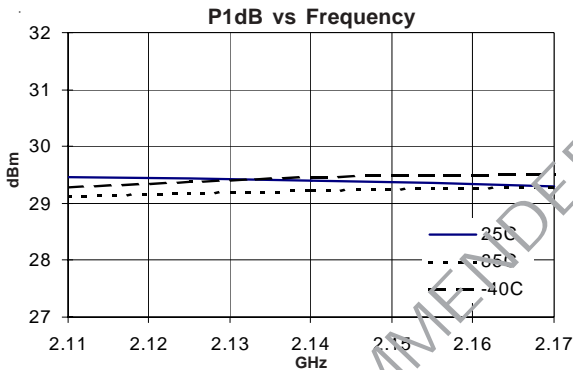
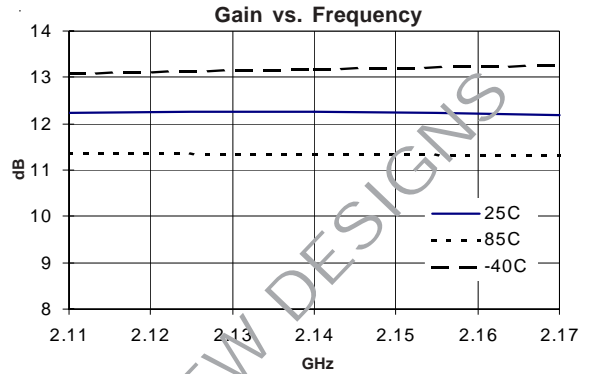
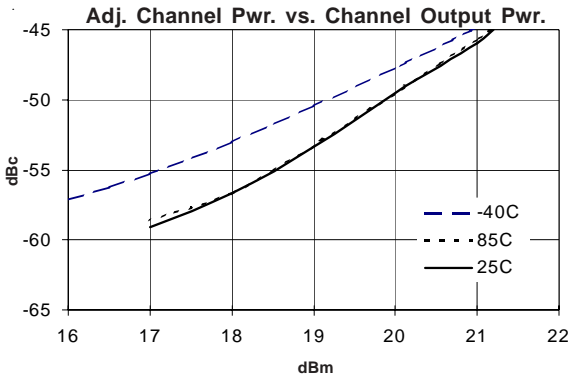

**ACP Tune
2110 - 2170 MHz Schematic**

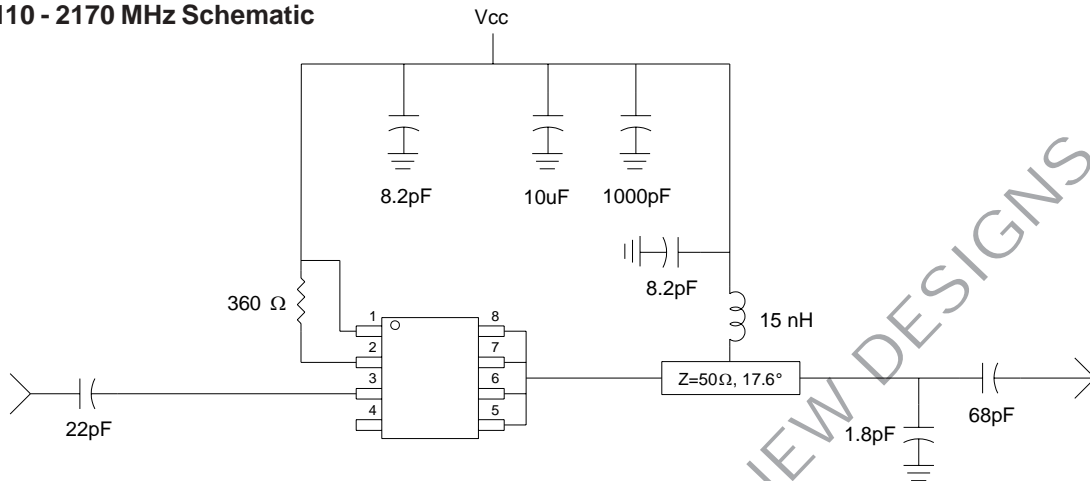

2110 - 2170 MHz Evaluation Board Layout

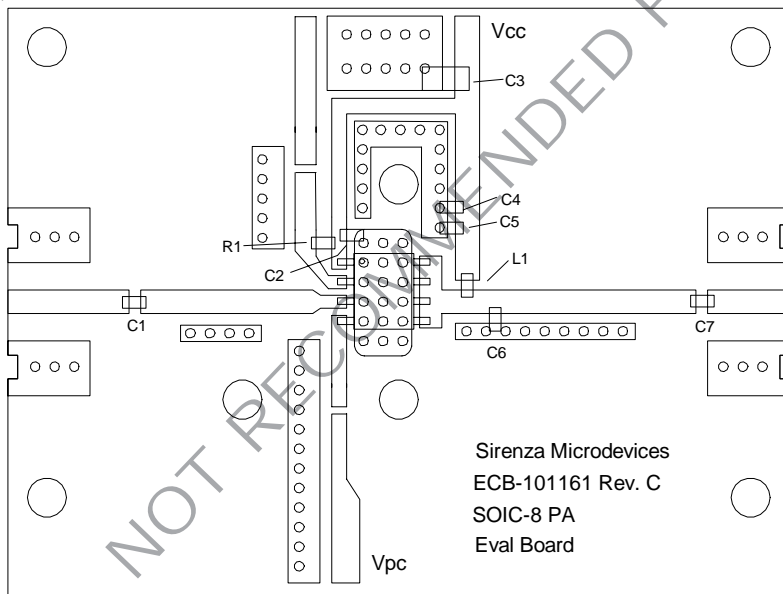

Ref. Des.	Value	Part Number
C1	22pF, 5%	Rohm MCH18 series
C2, C5	8.2pF, ±0.5pF	Rohm MCH18 series
C3	10uF, 10%	AVX TAJB106K020R
C4	1000pF, 5%	Rohm MCH18 series
C6	1.8pF, ±0.25pF	Rohm MCH18 series
C7	68pF, 5%	Rohm MCH18 series
L1	15nH, 5%	Toko LL1608-FS series
R1	360 Ohm, 5%	Rohm MCR03 series

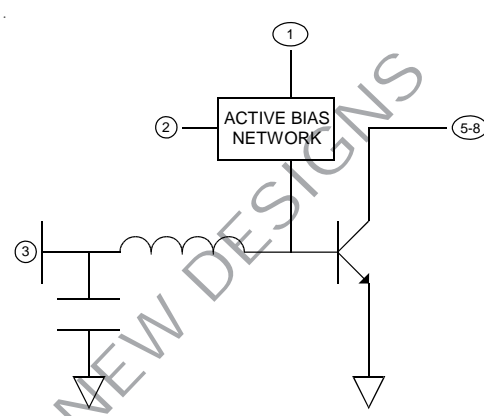
Pin #	Function	Description	Device Schematic
1	Vcc	VCC is the supply voltage for the active bias network. Bypassing in the appropriate location as shown on application schematic is required for optimum RF performance.	
2	Vbias	Vbias is the bias control pin for the active bias network. Device current is set by the current into this pin. Recommended configuration shown in the Application Schematic is required for optimum RF performance.	
3	RF In	RF input pin. This pin requires the use of an external DC blocking capacitor.	
4	N/C	No connection	
5, 6, 7, 8	RF Out/Vcc	RF output and bias pin. Bias should be supplied to this pin through an external RF choke. Because DC biasing is present on this pin, a DC blocking capacitor should be used in most applications (see application schematic). The supply side of the bias network should be well bypassed. An output matching network is necessary for optimum performance.	
EPAD	Gnd	Exposed area on the bottom side of the package needs to be soldered to the ground plane of the board for thermal and RF performance. Several vias should be located under the EPAD as shown in the recommended land pattern (page 5).	

Absolute Maximum Ratings

Parameter (Ta = 25°C)	Absolute Limit
Max. Supply Current (I _{CC}) at V _{CC} typ.	750 mA
Max. Device Voltage (V _{CC}) at I _{CC} typ.	6.0 V
Max. RF Input Power	29 dBm
Max. Junction Temp. (T _J)	+160 °C
Max. Storage Temp.	+150 °C

Operation of this device beyond any one of these limits may cause permanent damage. For reliable continuous operation, the device voltage and current must not exceed the maximum operating values specified in the table on page one.

Bias Conditions should also satisfy the following expression:

$$I_{CC} V_{CC} (\max) < (T_J - T_L) / R_{\theta j-l}$$

Caution: ESD sensitive

Appropriate precautions in handling, packaging and testing devices must be observed.

The Moisture Sensitivity Level rating for this device is level 1 (MSL-1) based on the JEDEC 22-A113 standard classification. No special moisture packaging/handling is required during storage, shipment, or installation of the devices.

SPA-1318 2150 MHz 1 Watt Power Amp.

Part Number Ordering Information

Part Number	Devices Per Reel	Reel Size
SPA-1318	500	7"

Package Outline Drawing

(See SMDI MPO-101644 for tolerances, available on our website)

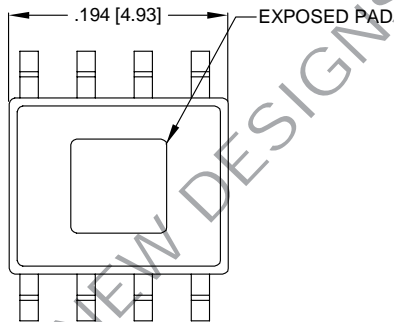
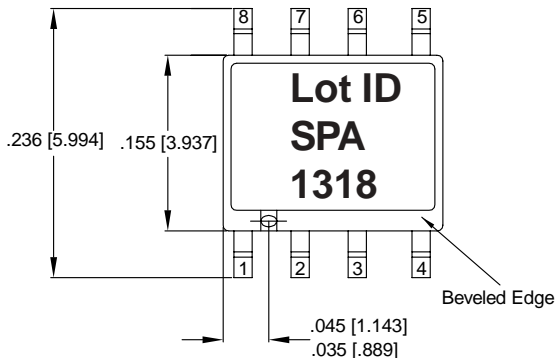

TOP VIEW

BOTTOM VIEW

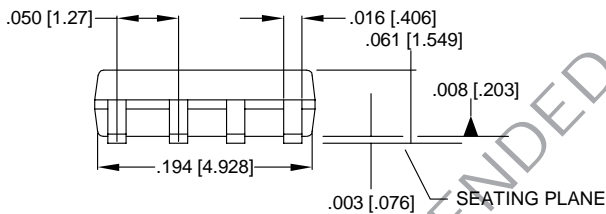

SIDE VIEW

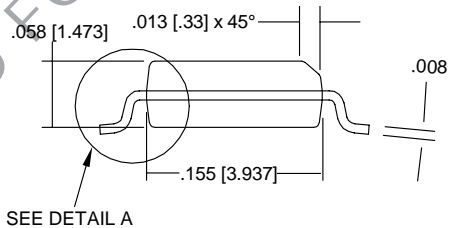

SEE DETAIL A

END VIEW

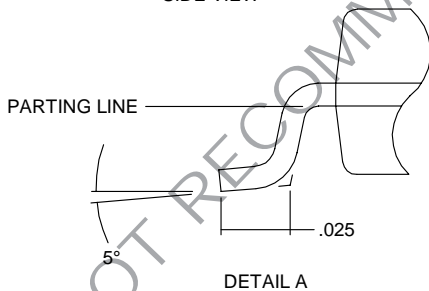

DETAIL A

Recommended Land Pattern

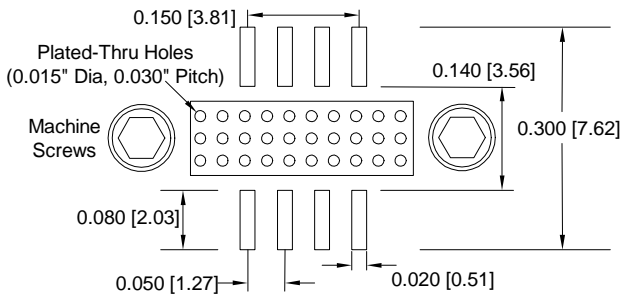

Note: DIMENSIONS ARE IN INCHES [MM]