

### Features

- Schottky Barrier Chip
- Guard Ring Die Construction for Transient Protection
- High Current Capability
- Low Power Loss, High Efficiency
- High Surge Current Capability
- For Use in Low Voltage, High Frequency Inverters, Free Wheeling, and Polarity Protection Applications

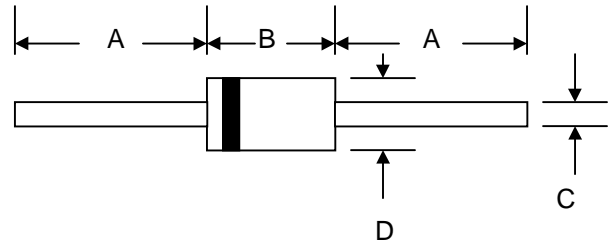

### Mechanical Data

- Case: DO-201AD, Molded Plastic
- Terminals: Plated Leads Solderable per MIL-STD-202, Method 208
- Polarity: Cathode Band
- Weight: 1.2 grams (approx.)
- Mounting Position: Any
- Marking: Type Number
- **Lead Free: For RoHS / Lead Free Version, Add "-LF" Suffix to Part Number, See Page 4**

DO-201AD		
Dim	Min	Max
A	25.4	—
B	7.20	9.50
C	1.20	1.30
D	4.80	5.30
All Dimensions in mm		

### Maximum Ratings and Electrical Characteristics @ $T_A=25^\circ\text{C}$ unless otherwise specified

Single Phase, half wave, 60Hz, resistive or inductive load.  
For capacitive load, derate current by 20%.

Characteristic	Symbol	SR320	SR330	SR340	SR350	SR360	SR380	SR3100	Unit
Peak Repetitive Reverse Voltage	$V_{RRM}$								V
Working Peak Reverse Voltage	$V_{RWM}$	20	30	40	50	60	80	100	
DC Blocking Voltage	$V_R$								
RMS Reverse Voltage	$V_{R(RMS)}$	14	21	28	35	42	56	70	V
Average Rectified Output Current (Note 1) @ $T_L = 95^\circ\text{C}$	$I_O$	3.0							A
Non-Repetitive Peak Forward Surge Current 8.3ms Single half sine-wave superimposed on rated load (JEDEC Method)	$I_{FSM}$	80							A
Forward Voltage @ $I_F = 3.0\text{A}$	$V_{FM}$	0.50		0.75		0.85		V	
Peak Reverse Current @ $T_A = 25^\circ\text{C}$ At Rated DC Blocking Voltage @ $T_A = 100^\circ\text{C}$	$I_{RM}$	0.5 20							mA
Typical Junction Capacitance (Note 2)	$C_j$	250							pF
Typical Thermal Resistance (Note 1)	$R_{\theta JA}$	20							$^\circ\text{C/W}$
Operating and Storage Temperature Range	$T_j, T_{STG}$	-65 to +150							$^\circ\text{C}$

Note: 1. Valid provided that leads are kept at ambient temperature at a distance of 9.5mm from the case.  
2. Measured at 1.0 MHz and applied reverse voltage of 4.0V D.C.

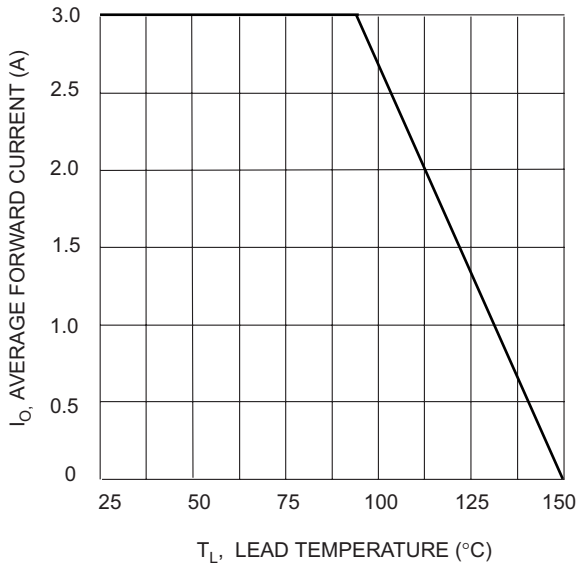

Fig. 1 Forward Current Derating Curve

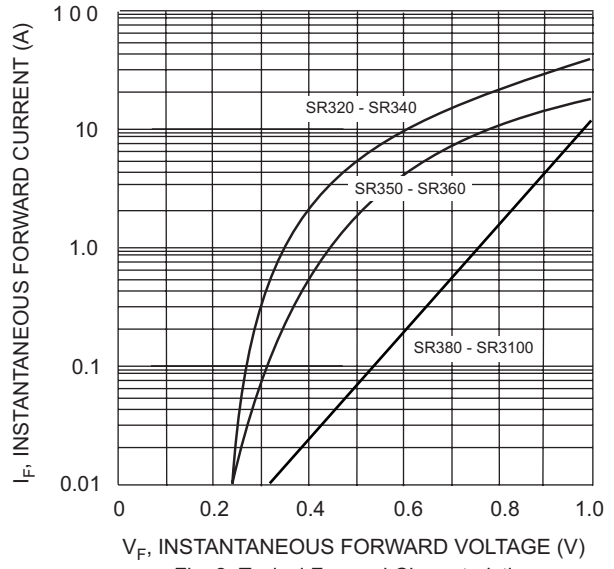

Fig. 2 Typical Forward Characteristics

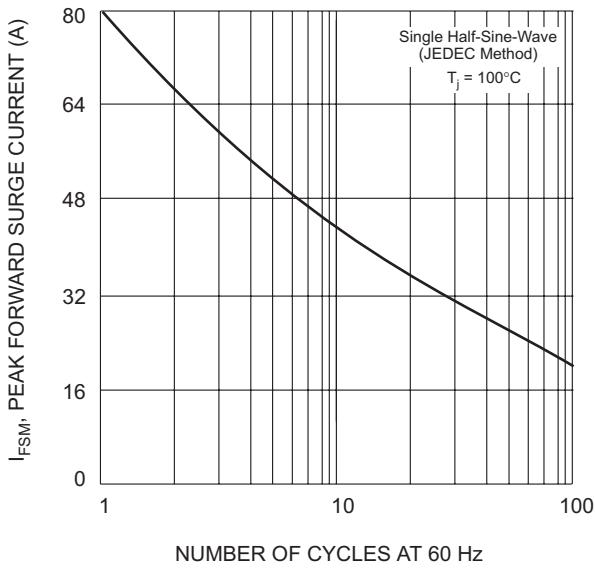

Fig. 3 Max Non-Repetitive Peak Fwd Surge Current

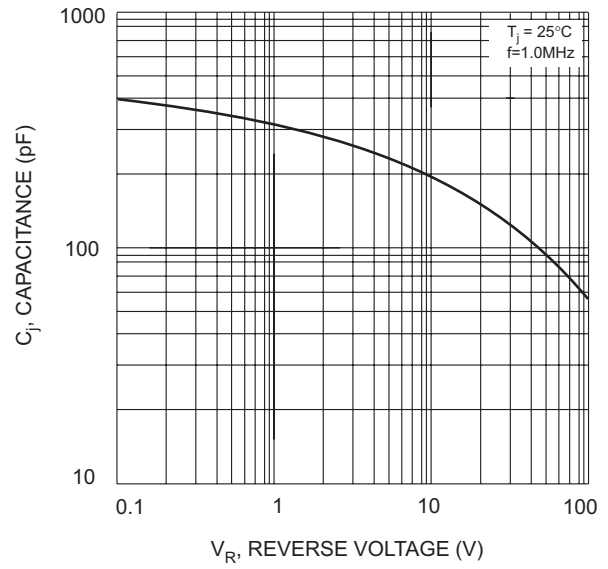

Fig. 4 Typical Junction Capacitance

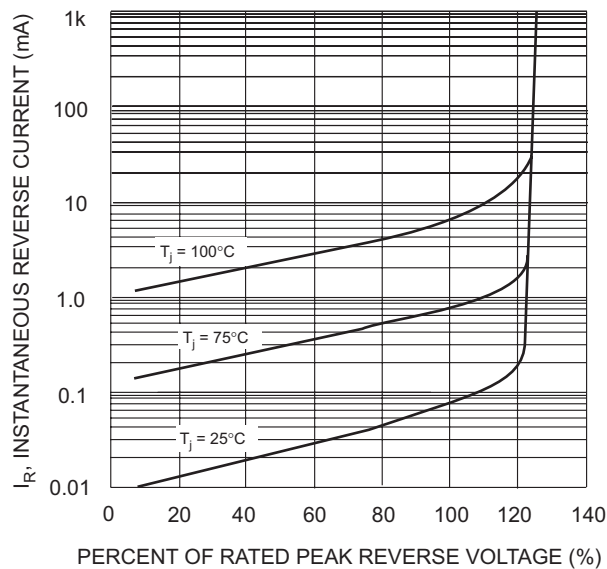
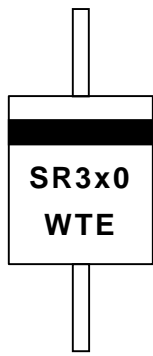

Fig. 5 Typical Reverse Characteristics

## MARKING INFORMATION



Cathode = Polarity Band  
 SR3x0 = Device Number  
 x = 2, 3, 4, 5, 6, 8 or 10  
 WTE = Manufacturer's Logo

## TAPING SPECIFICATIONS

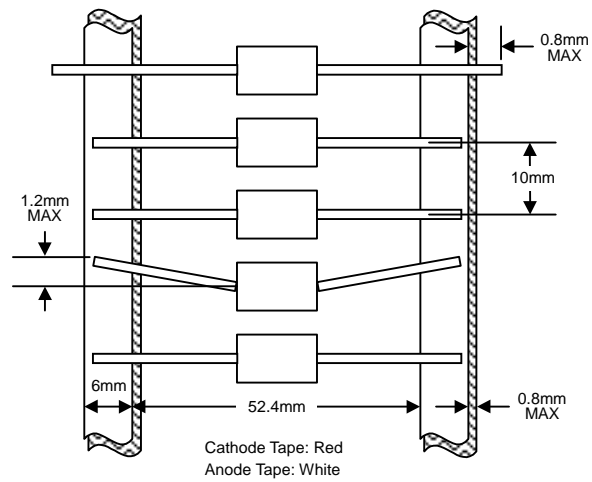

## PACKAGING INFORMATION

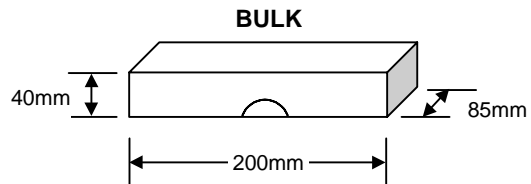
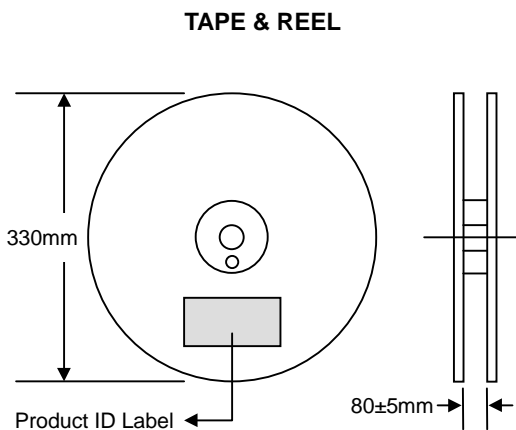

Packaging	Reel Diameter / Box Size (mm)	Quantity (PCS)	Carton Size (mm)	Quantity (PCS)	Approx. Gross Weight (KG)
<b>TAPE &amp; REEL</b>	330	1,200	370 x 370 x 420	6,000	10.0
<b>TAPE &amp; BOX</b>	255 x 75 x 150	1,200	400 x 273 x 415	12,000	17.0
<b>BULK</b>	200 x 85 x 40	500	459 x 214 x 256	12,500	16.0

**Note:** 1. Paper reel, white or gray color. Core material: plastic or metal.  
 2. Components are packed in accordance with EIA standard RS-296-E.

## ORDERING INFORMATION

Product No.	Package Type	Shipping Quantity
SR320-T3	DO-201AD	1200/Tape & Reel
<b>SR320-TB</b>	DO-201AD	1200/Tape & Box
SR320	DO-201AD	500 Units/Box
SR330-T3	DO-201AD	1200/Tape & Reel
<b>SR330-TB</b>	DO-201AD	1200/Tape & Box
SR330	DO-201AD	500 Units/Box
SR340-T3	DO-201AD	1200/Tape & Reel
<b>SR340-TB</b>	DO-201AD	1200/Tape & Box
SR340	DO-201AD	500 Units/Box
SR350-T3	DO-201AD	1200/Tape & Reel
<b>SR350-TB</b>	DO-201AD	1200/Tape & Box
SR350	DO-201AD	500 Units/Box
SR360-T3	DO-201AD	1200/Tape & Reel
<b>SR360-TB</b>	DO-201AD	1200/Tape & Box
SR360	DO-201AD	500 Units/Box
SR380-T3	DO-201AD	1200/Tape & Reel
<b>SR380-TB</b>	DO-201AD	1200/Tape & Box
SR380	DO-201AD	500 Units/Box
SR3100-T3	DO-201AD	1200/Tape & Reel
<b>SR3100-TB</b>	DO-201AD	1200/Tape & Box
SR3100	DO-201AD	500 Units/Box

1. Products listed in **bold** are WTE **Preferred** devices.
2. Shipping quantity given is for minimum packing quantity only. For minimum order quantity, please consult the Sales Department.
3. **To order RoHS / Lead Free version (with Lead Free finish), add "-LF" suffix to part number above. For example, SR320-TB-LF.**

Won-Top Electronics Co., Ltd (WTE) has checked all information carefully and believes it to be correct and accurate. However, WTE cannot assume any responsibility for inaccuracies. Furthermore, this information does not give the purchaser of semiconductor devices any license under patent rights to manufacturer. WTE reserves the right to change any or all information herein without further notice.

**WARNING: DO NOT USE IN LIFE SUPPORT EQUIPMENT.** WTE power semiconductor products are not authorized for use as critical components in life support devices or systems without the express written approval.

**Won-Top Electronics Co., Ltd.**

No. 44 Yu Kang North 3rd Road, Chine Chen Dist., Kaohsiung, Taiwan

**Phone:** 886-7-822-5408 or 886-7-822-5410

**Fax:** 886-7-822-5417

**Email:** sales@wontop.com

**Internet:** http://www.wontop.com

*We power your everyday.*