

Product Description

The Sirenza Microdevices' SRM-2016 is a high linearity active mixer for use in a wide variety of communication systems covering the 1700-2300 MHz frequency bands. This device operates from a single 5V supply and provides 12 dB of conversion gain while requiring only 0dBm input to the integrated LO driver. The SRM-2016 also includes an integrated on chip IF amplifier and is fabricated using Silicon Germanium (SiGe) device technology.

The RF and LO ports can be driven differential or single ended. Each broadband port has been designed to minimize performance degradation while operating into highly reactive components such as SAW filters. The device is packaged in an industry standard 16 pin TSSOP with exposed paddle for superb RF and thermal ground.

Functional Block Diagram

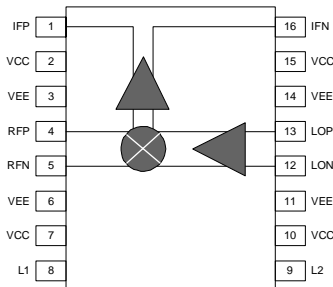

SRM-2016

1700 - 2300 MHz High Linearity Active Receive Mixer

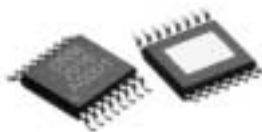

16 pin TSSOP with Exposed Ground Pad
 Package Footprint: 0.197 x 0.252 inches (5.0 x 6.4 mm)
 Package Height: 0.039 inches (1.0 mm)

Product Features

- Active mixer with 12dB conversion gain
- Integrated 0dBm LO drive and IF amplifier
- Differential or single-ended input
- Single supply operation (+5V)
- Broadband resistive 50Ω impedance on all three ports

Applications

- 1700-2300 MHz receivers

Product Specifications

Parameters	Test Conditions: $T_A = 25^\circ\text{C}$, $V_{CC} = 5.0\text{V}$, $P_{LO} = 0\text{dBm}$, $P_{RF} = -20\text{dBm}$, $f_F = 200\text{MHz}$	Unit	Min.	Typ.	Max.	Min.	Typ.	Max.
RF Frequency Range	For RF = 2000-2300 MHz operation, single-ended RF+LO drive is recommended.	MHz	1700		2000	2000		2300
LO Frequency Range		MHz	1400		2000	1700		2300
IF Frequency Range		MHz	30	200	300	30	200	300
Conversion Gain		dB	9	12	15	6	9	12
SSB Noise Figure		dB		14	17		16	19
Input IP3	RF1 = RF2 = -15 dBm/tone, 1 MHz spacing	dBm	12	15		12	16	
Input P1dB		dBm	1	2		3	5	
Leakage (LO-RF)		dBm		-60	-40		-30	-20
Leakage (LO-IF)		dBm		-30	-20		-30	-20
Leakage (RF-IF)		dBm		-53	-40		-35	-25
RF, LO, IF Return Loss	Matched to 50Ω, see Note 1, pages 3 & 5	dB		20			20	
Supply Voltage (Vcc)		V	+4.75	+5.0	+5.25	+4.75	+5.0	+5.25
Supply Current		mA		160	180		160	180
LO Drive	Matched to 50Ω	dBm	-3	0	+3	-3	0	+3
Thermal Resistance	junction-case	°C/W		46			46	

The information provided herein is believed to be reliable at press time. Sirenza Microdevices assumes no responsibility for inaccuracies or omissions. Sirenza Microdevices assumes no responsibility for the use of this information, and all such information shall be entirely at the user's own risk. Prices and specifications are subject to change without notice. No patent rights or licenses to any of the circuits described herein are implied or granted to any third party. Sirenza Microdevices does not authorize or warrant any Sirenza Microdevices product for use in life-support devices and/or systems.

Copyright 2002 Sirenza Microdevices, Inc. All worldwide rights reserved.
 522 Almanor Ave., Sunnyvale, CA 94085

Phone: (800) SMI-MMIC

1700-2000MHz Typical Device Performance

Conversion Gain vs Temperature
Plo = 0dBm

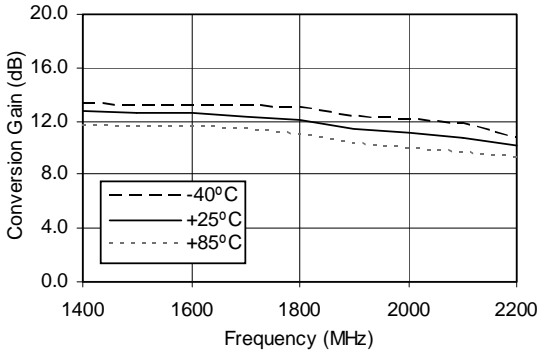

Input IP3 vs Temperature
Plo = 0dBm

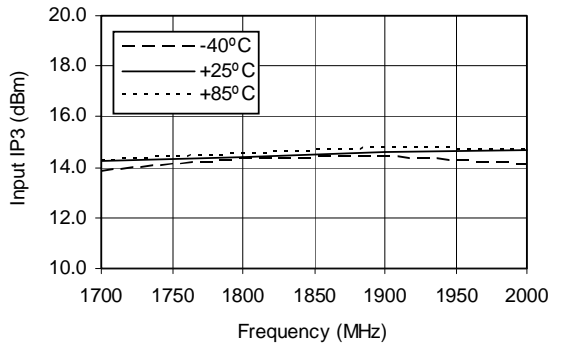

Conversion Gain vs LO Drive
T=+25°C

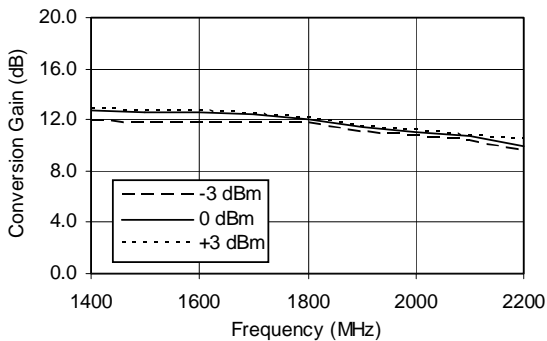

Input IP3 vs LO Drive
T=+25°C

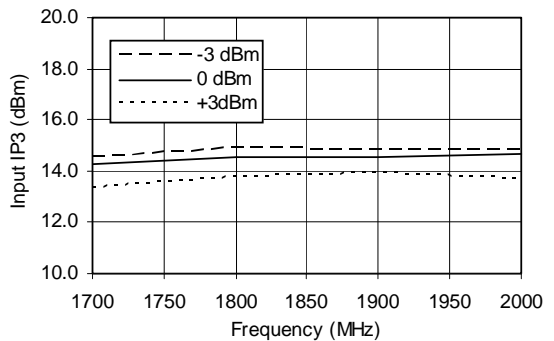

Leakages
Plo=0 dBm at pins, Prf=-20 dBm at pins,
T=+25°C

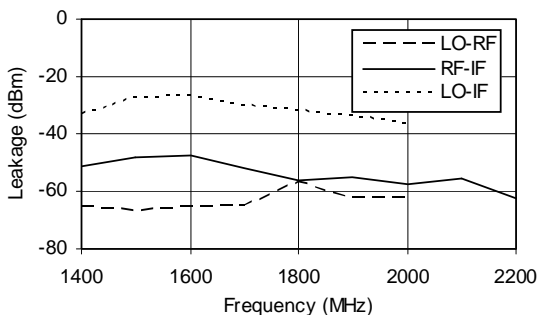

Noise Figure vs Temperature
Plo=0dBm

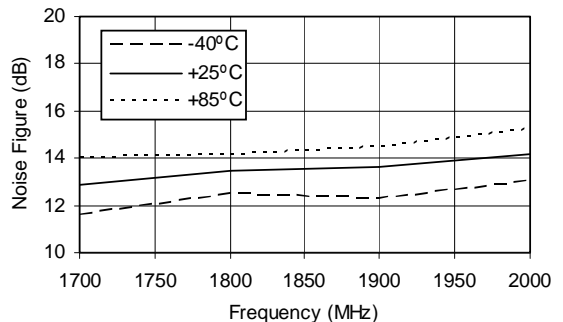

1700-2000MHz Typical Device Performance (continued)

RF & LO Return Loss (Note 1)
T=+25°C

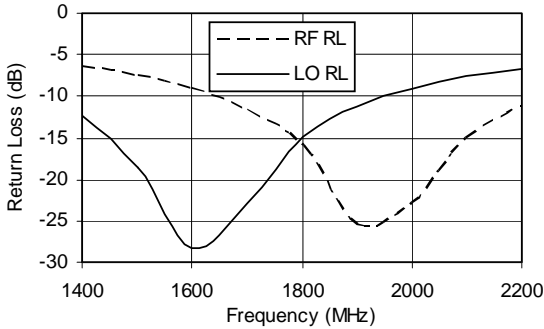

Input P1dB vs Temperature
P_{lo}=0 dBm

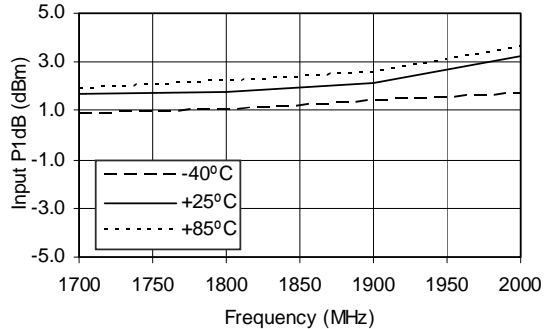

IF Return Loss (Note 1)
T=+25°C

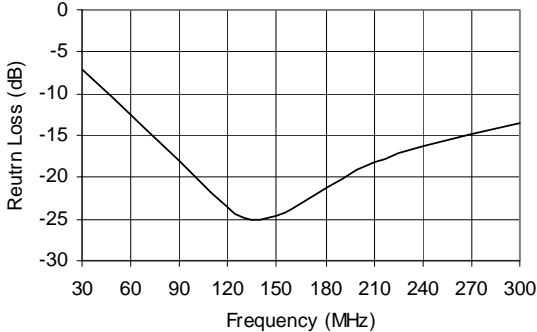

Input P1dB vs LO Drive
T=+25°C

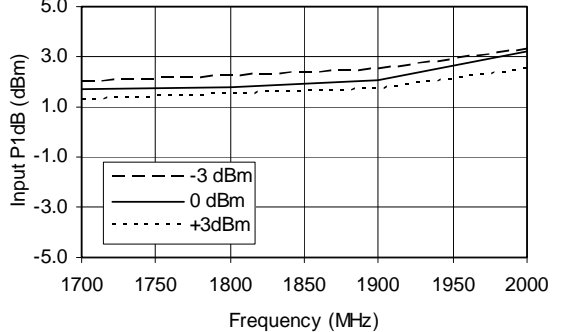

Note 1:

The return losses shown were measured with the SRM-2016 mounted on our FR4 evaluation boards using standard matching practices as indicated on the respective application schematic pages (7 & 8) herein. Users following the RF, LO and IF matching guidelines will achieve similar performance.

2000-2300MHz Typical Device Performance, Single-Ended Drive

Conversion Gain vs Temperature
Plo=0 dBm

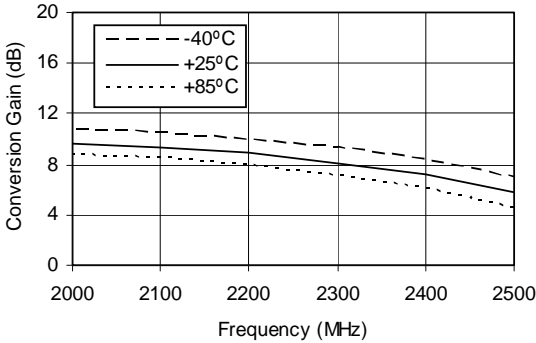

Input IP3 vs Temperature
Plo=0dBm

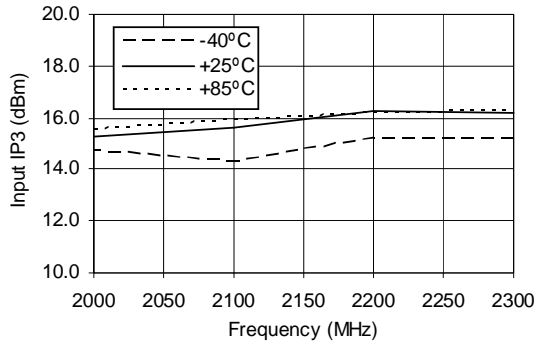

Conversion Gain vs LO Drive
T=+25°C

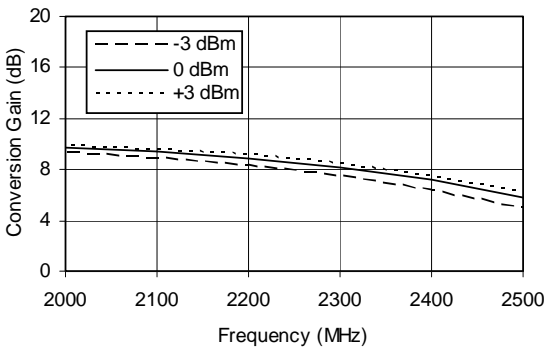

Input IP3 vs LO Drive
T=+25°C

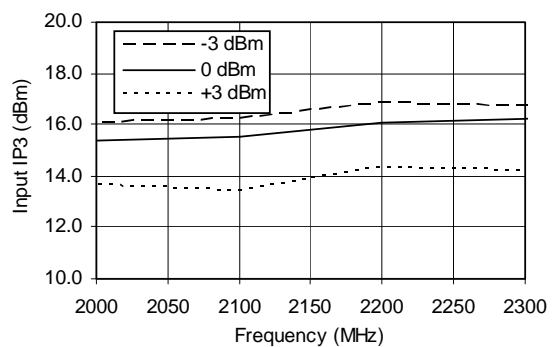

Leakages
Plo=0 dBm at pins, Prf=-20 dBm at pins,
T=+25°C

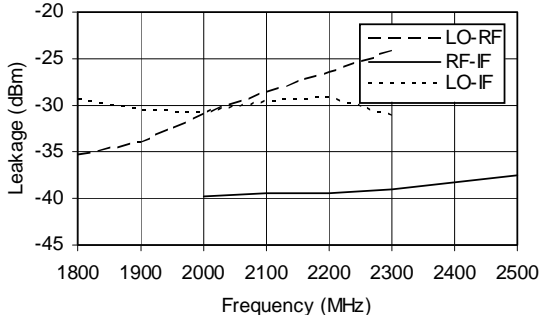

Input P1dB vs Temperature
Plo=0dBm

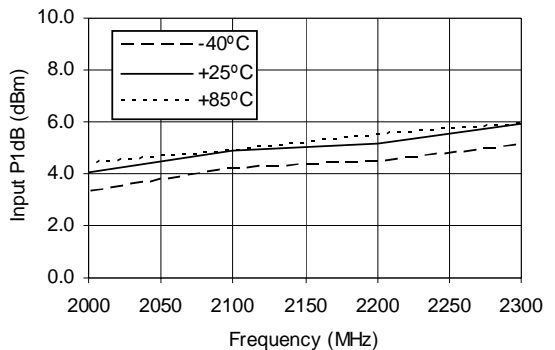

2000-2300MHz Typical Device Performance (continued)

RF & LO Return Loss (Note 1)
V_{cc}=5V, T=+25°C

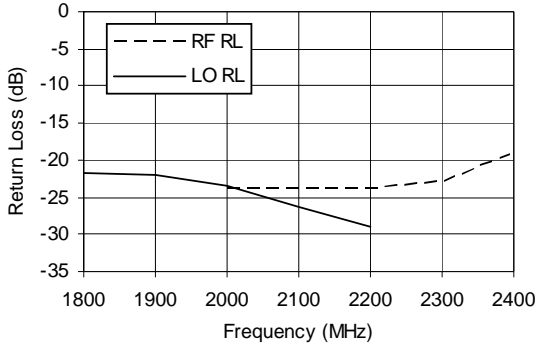

Input P1dB vs Temperature
P_{lo}=0dBm

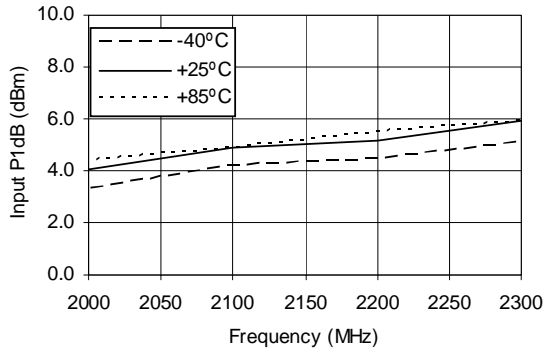

IF Return Loss (Note 1)
T=25°C

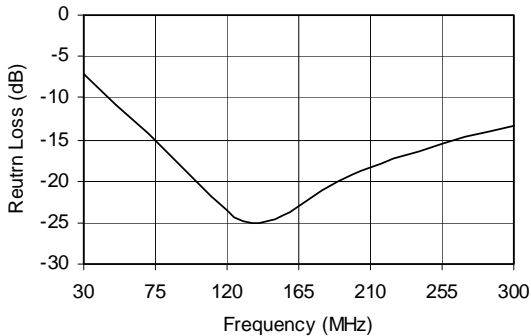

Input P1dB vs LO Drive
T=25°C

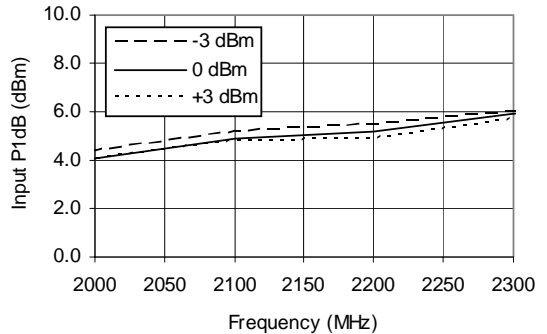

Note 1:

The return losses shown were measured with the SRM-2016 mounted on our FR4 evaluation boards using standard matching practices as indicated on the respective application schematic pages (7 & 8) herein. Users following the RF, LO and IF matching guidelines will achieve similar performance.

Package Dimensions ("16" Package)

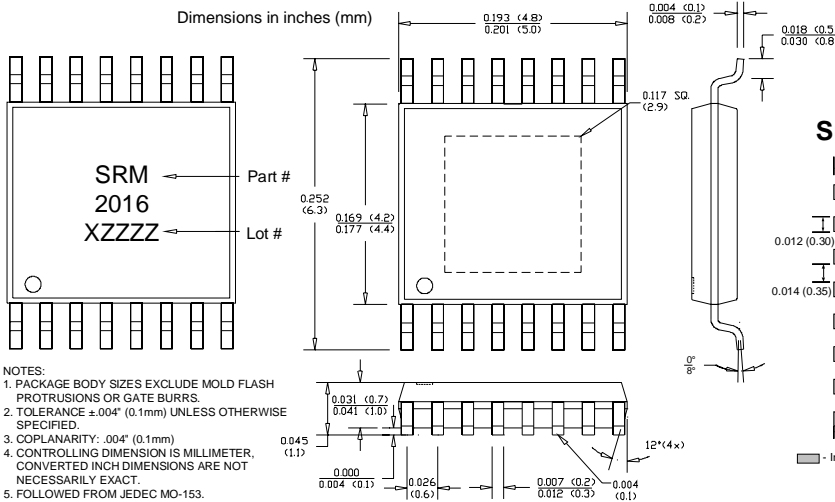

Suggested PCB Pad Layout

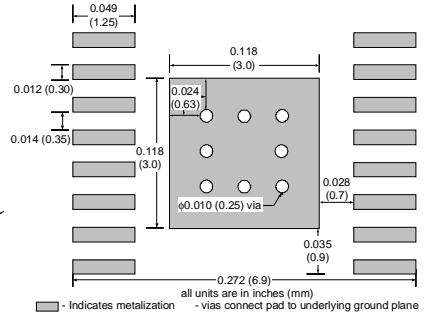

Pin Out Description

Pin #	Function	Description	Additional Comments
1	IFP	IF output, positive terminal	Nominal DC voltage is 1.6V. Output should be AC-coupled
2	VCC	Positive supply (+5V)	
3	VEE	Ground	
4	RFP	RF input, positive terminal	Nominal DC voltage is 2.1V. (Internally biased) Input should be AC-coupled.
5	RFN	RF input, negative terminal	Nominal DC voltage is 2.1V. (Internally biased) Input should be AC-coupled.
6	VEE	Ground	
7	VCC	Positive supply (+5V)	
8	L1	External inductor terminal	Nominal DC voltage is 5V, provided through off chip inductors.
9	L2	External inductor terminal	Nominal DC voltage is 5V, provided through off chip inductors.
10	VCC	Positive supply (+5V)	
11	VEE	Ground	
12	LON	LO input, negative terminal	Nominal DC voltage is 2.4V. (Internally biased) Input should be AC-coupled.
13	LOP	LO input, positive terminal	Nominal DC voltage is 2.4V. (Internally biased) Input should be AC-coupled.
14	VEE	Ground	
15	VCC	Positive supply (+5V)	
16	IFN	IF output, negative terminal	Nominal DC voltage is 1.6V. Output should be AC-coupled.

Absolute Maximum Ratings

Parameters	Value	Unit
Supply Voltage (Vcc)	+6.0	V _{DC}
LO Input (LOP+LON)	+10	dBm
RF Input (RFP, RFN)	+15	dBm
Operating Temperature	-40 to +85	°C
Storage Temperature	-65 to +150	°C

Operation of this device beyond any one of these limits may cause permanent damage. For reliable continuous operation the device voltage and current must not exceed the maximum operating values specified in the table on page one.

Part Number Ordering Information

Part Number	Reel Size	Devices/Reel
SRM-2016	7"	1000



Caution: ESD Sensitive

Appropriate precaution in handling, packaging and testing devices must be observed.

1700-2000MHz Application Schematic Differential Drive

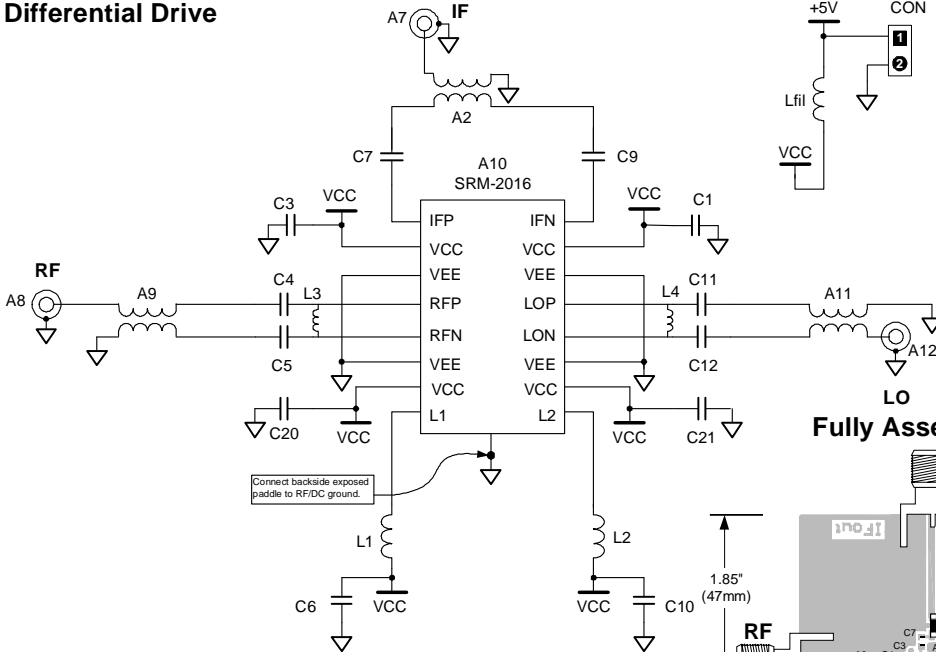

Fully Assembled PCB

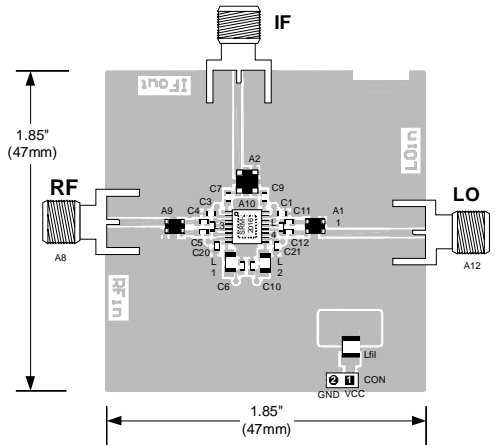

Bill of Materials (for 1700-2000MHz Evaluation Board P/N EEB102105)

Component Designator	Value	Qty	Vendor	Part Number	Description
A10		1	SMDI	SRM-2016	SiGe Receive Mixer
A7, A8, A12		3	Johnson Components	142-0701-851	SMA connector, end launch with tab, for 62 mil thick board
CON		1	Digikey	S1212-36-ND	2-pin header
A9, A11	1:1	2	Panasonic	EHF-FD1619	RF transformer
A2	1:1	1	Mini-Circuits	TC1-1	IF transformer
Lfil	1uH	1	Digikey	PCD1008CT-ND	Inductor, 1210 footprint, min. 200mA rating
C1, C3, C20, C21	6.8pF	4	Venkel	C0603COG500-6R8CNE	Capacitor, 0603 footprint
C6, C10	100pF	2	Venkel	C0603COG500-101JNE	Capacitor, 0603 footprint
C7, C9	120pF	2	Venkel	C0603COG500-121JNE	Capacitor, 0603 footprint
C4, C5	2.2pF	2	Venkel	C0603COG500-2R2CNE	Capacitor, 0603 footprint
C11, C12	3.3pF	2	Venkel	C0603COG500-3R3CNE	Capacitor, 0603 footprint
L1, L2	see Page 9	2	TOKO		Inductor, 0603 footprint, high Q series
L3	18nH	1	TOKO	LL1608-FS18NJ	Inductor, 0603 footprint, high Q series
L4	15nH	1	TOKO	LL1608-FS15NJ	Inductor, 0603 footprint, high Q series

2000-2300MHz Application Schematic, Single-Ended Drive

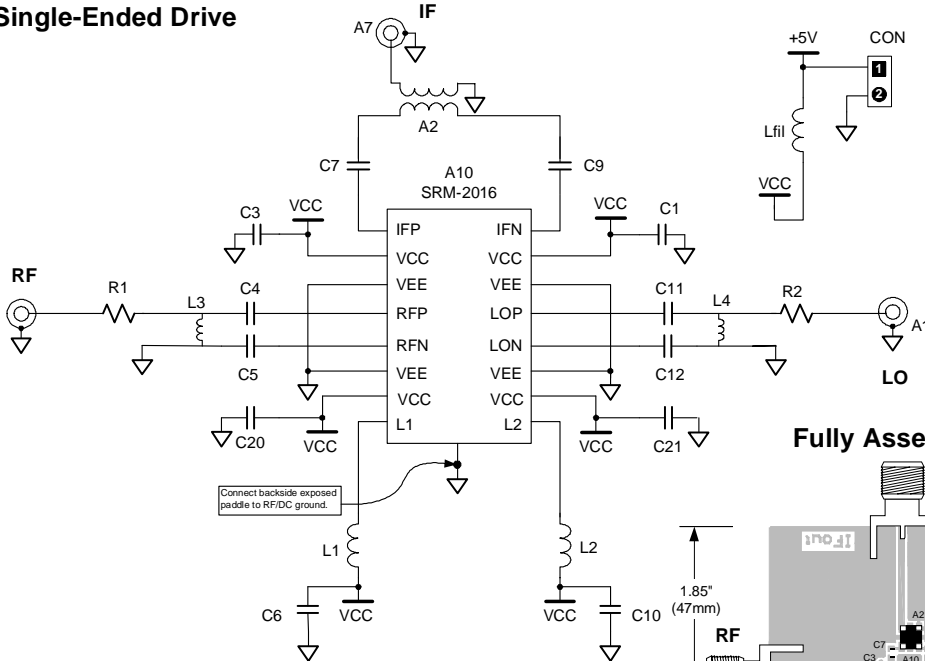

Connect backside exposed paddle to RF/DC ground.

Fully Assembled PCB

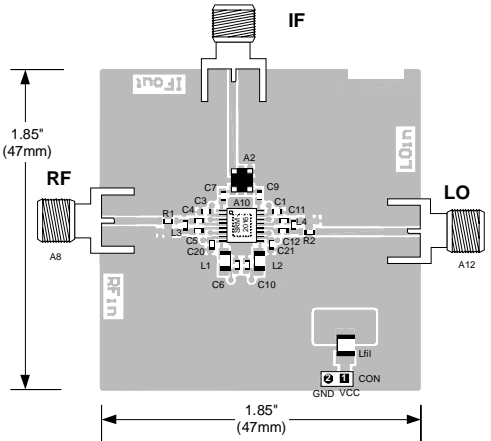

Bill of Materials (for 2000-2300MHz Evaluation Board P/N EEB102310)

Component Designator	Value	Qty	Vendor	Part Number	Description
A10		1	SMDI	SRM-2016	SiGe Receive Mixer
A7, A8, A12		3	Johnson Components	142-0701-851	SMA connector, end launch with tab, for 62 mil thick board
CON		1	Digikey	S1212-36-ND	2-pin header
A2	1:1	1	Mini-Circuits	TC1-1	IF transformer
Lfil	1uH	1	Digikey	PCD1008CT-ND	Inductor, 1210 footprint, min. 200mA rating
R1, R2	0Ω	2	Venkel	CR0603-16W-000T	Resistor, 0603 footprint
C1, C3, C20, C21	6.8pF	4	Venkel	C0603COG500-6R8CNE	Capacitor, 0603 footprint
C6, C10	100pF	2	Venkel	C0603COG500-101JNE	Capacitor, 0603 footprint
C7, C9	120pF	2	Venkel	C0603COG500-121JNE	Capacitor, 0603 footprint
C4, C5	2.2pF	2	Venkel	C0603COG500-2R2CNE	Capacitor, 0603 footprint
C11	3.3pF	1	Venkel	C0603COG500-3R3CNE	Capacitor, 0603 footprint
C12	2.7pF	1	Venkel	C0603COG500-2R7CNE	Capacitor, 0603 footprint
L1, L2	see Page 9	2	TOKO		Inductor, 0603 footprint, high Q series
L3, L4	6.8nH	2	TOKO	LL1608-FS6R8NJ	Inductor, 0603 footprint, high Q series

SiGe Receive Mixer: General Test Set-Up

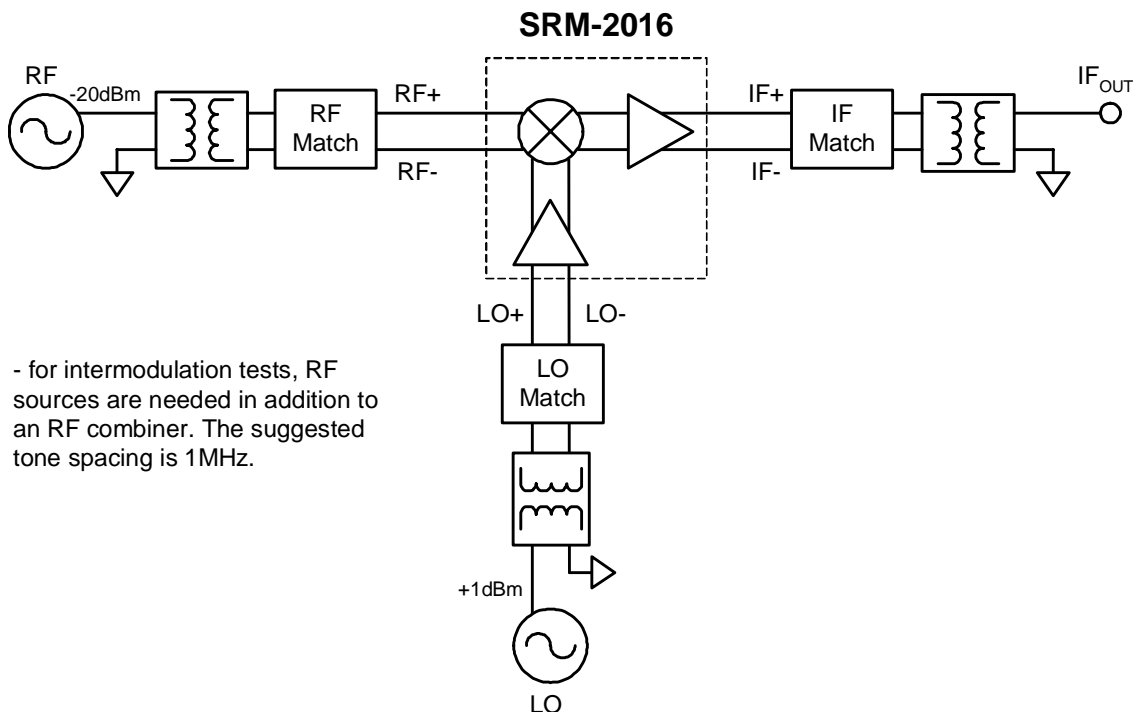

- for intermodulation tests, RF sources are needed in addition to an RF combiner. The suggested tone spacing is 1MHz.

The SRM-2016 utilizes an IF tank circuit to maximize performance across the entire IF bandwidth. The off-chip inductors L1 and L2 resonate with on-chip capacitors (4pF) to provide IF tunability. Therefore, L1 and L2 must be selected such that the resonance occurs at the desired IF. The table below provides the inductor values required on

the evaluation board for some common intermediate frequencies. By default, all evaluation boards are shipped with L1 = L2 = 100nH, resulting in a 200 MHz resonant IF. Also note, L1 and L2 should be placed within 1mm (0.039 in) of pins 9 and 10 for optimal performance.

IF (MHz) "typical"	L1, L2 (nH)	TOKO Part Number
70	680	LL2012-FHR68J
150	150	LL1608-FSR15J
200	100	LL1608-FSR10J
300	39	LL1608-FS39NJ

The following procedure may be used to ensure that the proper inductor values have been selected for a given IF:

1. Using the "General Test Set-Up" prepare the evaluation board for a conversion gain measurement.
2. Enable the "Max Hold" function on the spectrum analyzer and set the "SPAN" to 200 MHz.
3. Vary the LO frequency while maintaining a constant input frequency.
4. The resonance will be observed at the peak of the response.