

16Dot*16Dot LED DOT MATRIX

MODEL : SSD-D9696TDM

Seoul Semiconductor Co., Ltd.

148-29, Kasan-Dong, KeumChun-Ku, Seoul, Korea
TEL : 82-2-3281-6269 FAX: 82-2-858-5537
Web-site : www.seoul-semicon.co.kr

1. 특성 (FEATURES)

COLOR	RED, GREEN, AMBER
DIMENSION (mm)	96.0 * 96.0 (mm)
NUMBER OF DOT	256
Drive mode	Dynamic Drive (1/16 Duty)
PROTECTION	WATCHDOG FUNCTION
WEIGHT (g)	-

2. 전기적 특성(ELECTRICAL SPECIFICATION)

(Ta=25°C)

Parameter	Symbol	Red	GREEN	-	Unit
Power dissipation *	P _D	3.84	3.53	-	W
Foward current	I _F	30	30	-	mA
Peak foward current **	I _{FP}	60	60	-	mA
Reverse voltage	V _R	5			V
Operating temperature	Topr	-10 ~ +60			°C
Storage temperature	Tstg	-20 ~ +70			°C

* conditions: I_{FP} = 60mA, DUTY = 1/10

** conditions: I_{FP} = Pulse width Tw ≤ 0.1ms, Duty ratio ≤ 1/10

3. 전기광학적 특성(Electrical and optical characteristics)

- 일반오차(GENERAL ALLOWANCE) : ±15%

(Ta=25°C)

Parameter	Condition	Symbol	Red			Green			-			Unit
			Min	Typ	Max	Min	Typ	Max	Min	Typ	Max	
FORWARD Voltage	I _F =20mA	V _F	-	2.02	2.5	-	1.8	2.3	-	-	-	V
Reverse current	V _R =5V	I _R	-	-	100	-	-	100	-	-	-	μA
Peak wavelength	I _F =20mA	λ _p	-	657	-	-	576	-	-	-	-	nm
Spectral half-power bandwidth	I _F =20mA	Δλ	-	24	-	-	21	-	-	-	-	nm
VIEWING ANGLE	I =20mA	2θ 1/2	-	120	-	-	120	-	-	-	-	DEG



SEOUL Semiconductor

제품명

SSD-D9696TDM

발행일

04.09.15

REV

2

SHEETS

1/8

4. 광학적 특성(OPTICAL SPECIFICATION)

(Ta=25°C)

ITEM		SYMBOL	MIN.	TYP.	MAX.	UNIT
LUMINOUS INTENSITY ***	RED GREEN	Lv	-	160 267	-	cd/m ²
PEAK EMISSION WAVELENGTH	RED GREEN	λ_p	-	657 576	-	nm
VIEWING ANGLE	HORIZONTAL VERTICAL	2θ 1/2	- -	120 120	- -	deg

*** Condition :

Measuring instrument : BM-7

Measured area is described on the drawing

Measured Distance : 1m

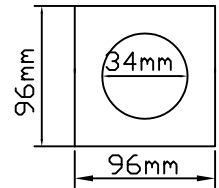

5. 핀이름(PIN NAMES)

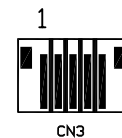
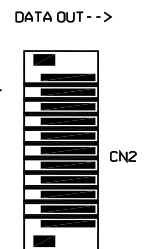
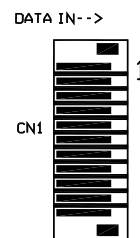
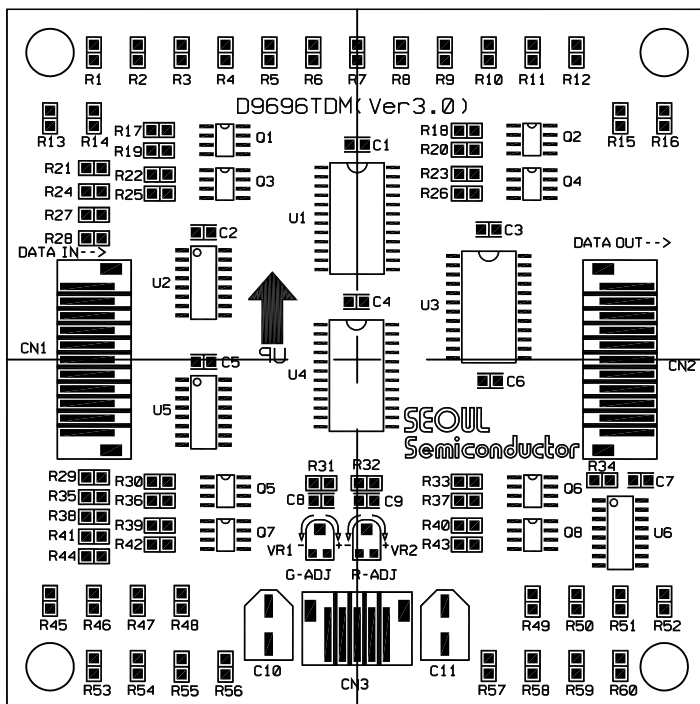

<VIEW OF BOTTOM>



SEOUL Semiconductor

제품명

SSD-D9696TDM

발행일

04.09.15

REV

2

SHEETS

2

8

6. 외관 (Demension)

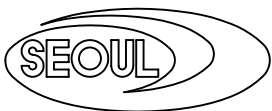
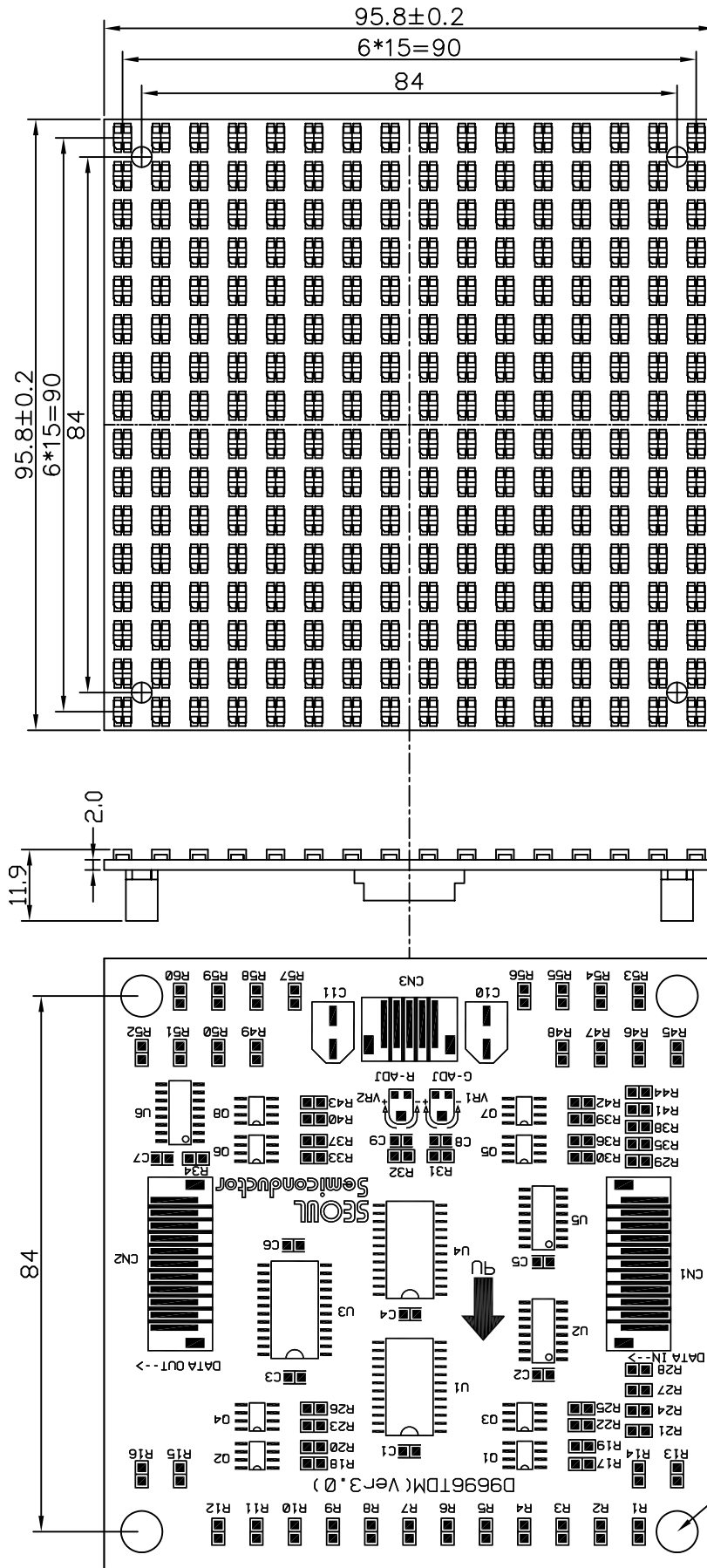

SEOUL Semiconductor

제품명	발행일	REV
		2
SSD-D9696TDM	04.09.15	SHEETS
		3 / 8

7. 연결단자(HARNESS)

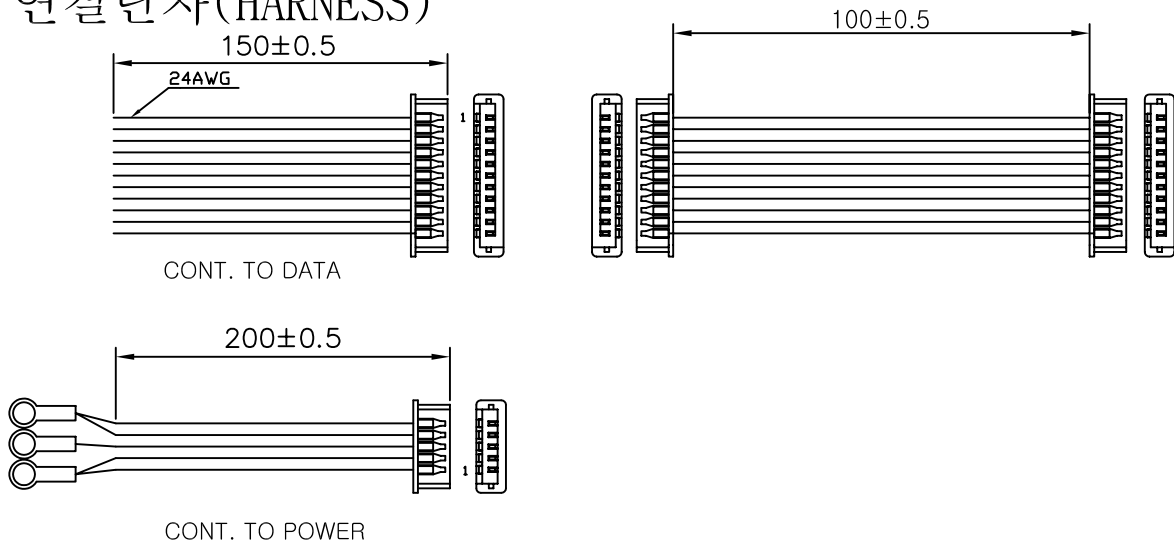

* 사전예고없이 변경될 수 있습니다.

* It can be changed without preliminary advance notice.

8. 커넥터 기능(CONNECTOR FUNCTION)

-각부의 커넥터의 기본 기능은 다음과 같다.

1) CONNECTOR

NO.	CONNECTOR NAME	MAKER	TYPE NO.	QTY
CN1	INPUT SIGNAL	JST	B11B-PH-SM3-TB	1
CN2	OUTPUT SIGNAL	JST	B11B-PH-SM3-TB	1
CN3	SOURCES OF ELECTRICITY	JST	B5B-PH-SM3-TB	1

2) SOURCE OF ELECTRICITY

NO.	LINE NAME	FUNCTION
1	GND	GROUND FOR CIRCUIT AND LED
2	GND	
3	VCC	SUPPLY VOLTAGE FOR CIRCUIT
4	VLED	SUPPLY VOLTAGE FOR LED
5	VLED	SUPPLY VOLTAGE FOR LED



SEOUL Semiconductor

제품명

SSD-D9696TDM

발행일

04.09.15

REV

2

SHEETS

4/8

9. INPUT/OUTPUT SIGNAL

INPUT SIGNAL(CN1)		OUTPUT SIGNAL(CN2)		POWER(CN3)	
NO	SIGNAL NAME	NO	SIGNAL NAME	NO	SIGNAL NAME
1	RED DATA	1	RED DATA	1	GND
2	CLOCK	2	CLOCK	2	GND
3	LATCH	3	LATCH	3	VCC
4	A0	4	A0	4	VLED
5	A1	5	A1	5	VLED
6	A2	6	A2		
7	A3	7	A3		
8	$\overline{\text{ENABLE}}$	8	$\overline{\text{ENABLE}}$		
9	GREEN DATA	9	GREEN DATA		
10	NC	10	NC		
11	GROUND	11	GROUND		

NO	CONNECTOR NAME	MAKER	TYPE NO.	QTY
1	INPUT SIGNAL (CN1)	JST	B11B-PH-SM3-TB	1
2	OUTPUT SIGNAL(CN2)	JST	B11B-PH-SM3-TB	1
3	POWER(CN3)	JST	B5B-PH-SM3-TB	1

10. 신호선 접속(SIGNAL CABLE CONNECTION)

1) DATA 진행방향 (DYNAMIC MODULE 적용)

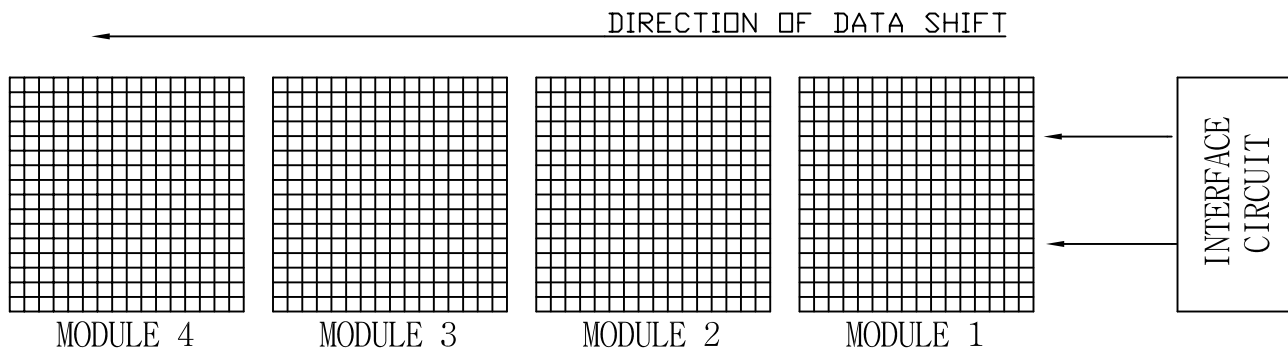

(FRONT VIEW)



SEOUL Semiconductor

제품명	발행일	REV
SSD-D9696TDM	04.09.15	2
		SHEETS
		5/8

11. 타이밍 차트 (TIMMING CHART)

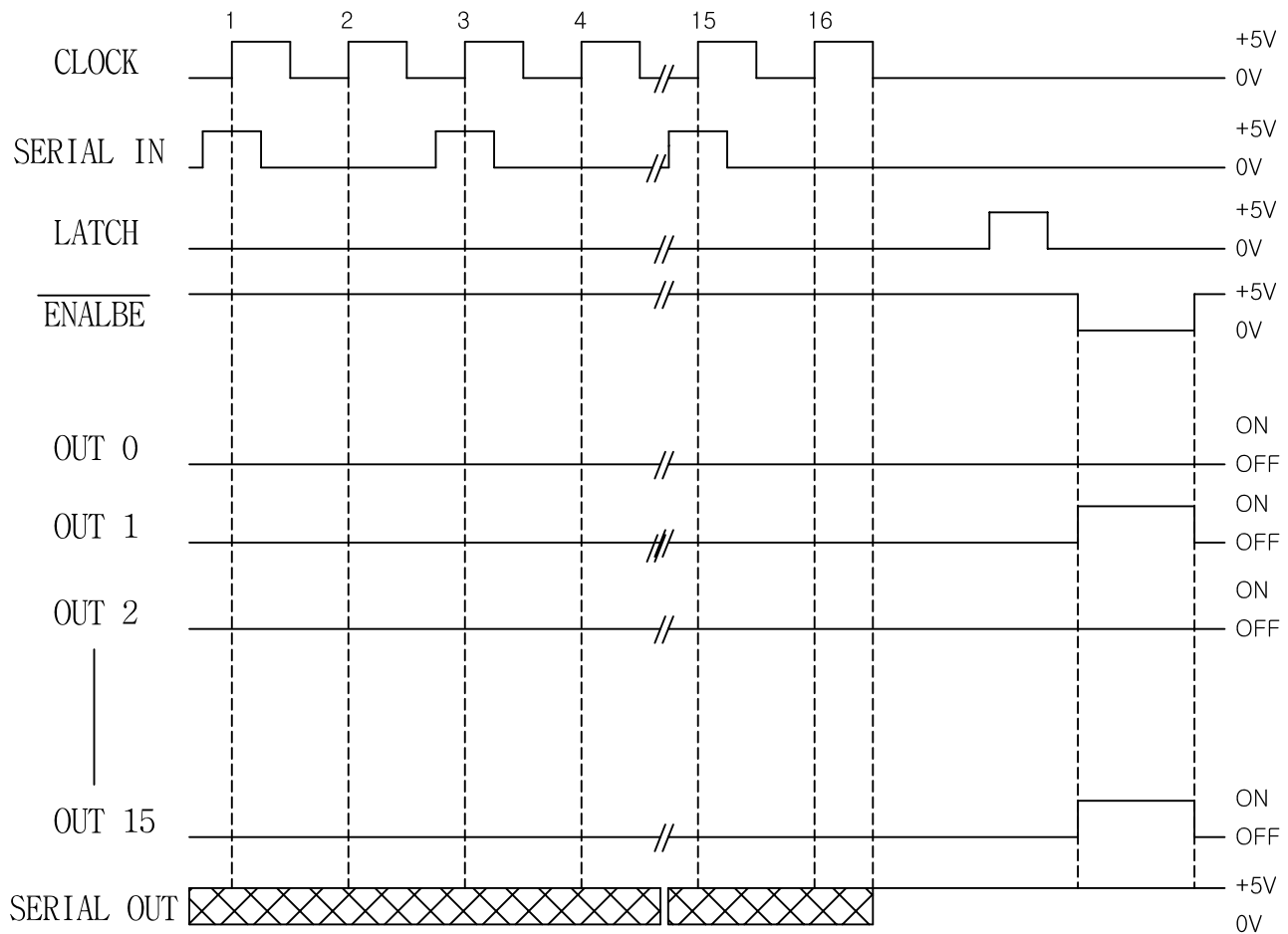

(NOTE) Latches are level sensitive (not edge triggered).
 LATCH-terminal = H level, latches become transparent; LATCH-terminal = L level, latches hold data.
 ENALBE-terminal = H level, all outputs (OUT0-15) are off.
 SERIAL-OUT changes state on the falling edges of clock.

Recommended Operating Condition

CHARACTERISTIC	SYMBOL	CONDITION	MIN.	TYP.	MAX.	UNIT
Supply Voltage	VDD	-	4.5	5.0	5.5	V
Output Voltage	VOUT	-	-	-	9	V
Output Current	IO	OUTn	5	-	115	mA
	IOH	SERIAL OUT	-	-	1.0	
	OIL	SERIAL OUT	-	-	-1.0	
Input Voltage	VIH	-	0.7VDD	0.7VDD	VDD+0.3	V
	VIL	-	-0.3	-0.3	0.3VDD	
LATCH Pulse Width	tw LAT	VDD = 4.5 ~ 5.5 V	15	-	-	ns
CLOCK Pulse Width	tw CLK		15	-	-	ns
Set up Time for DATA	tsetup(D)		20	-	-	ns
Hold Time for DATA	thold(D)		20	-	-	ns
Set up Time for LATCH	tsetup(L)		15	-	-	ns
Clock Frequency	fCLK	Cascade operation	-	-	25	MHz



SEOUL Semiconductor

제품명	발행일	REV
		2
SSD-D9696TDM	04.09.15	SHEETS
		6/8

12. 블럭도 (BLOCK DIAGRM)

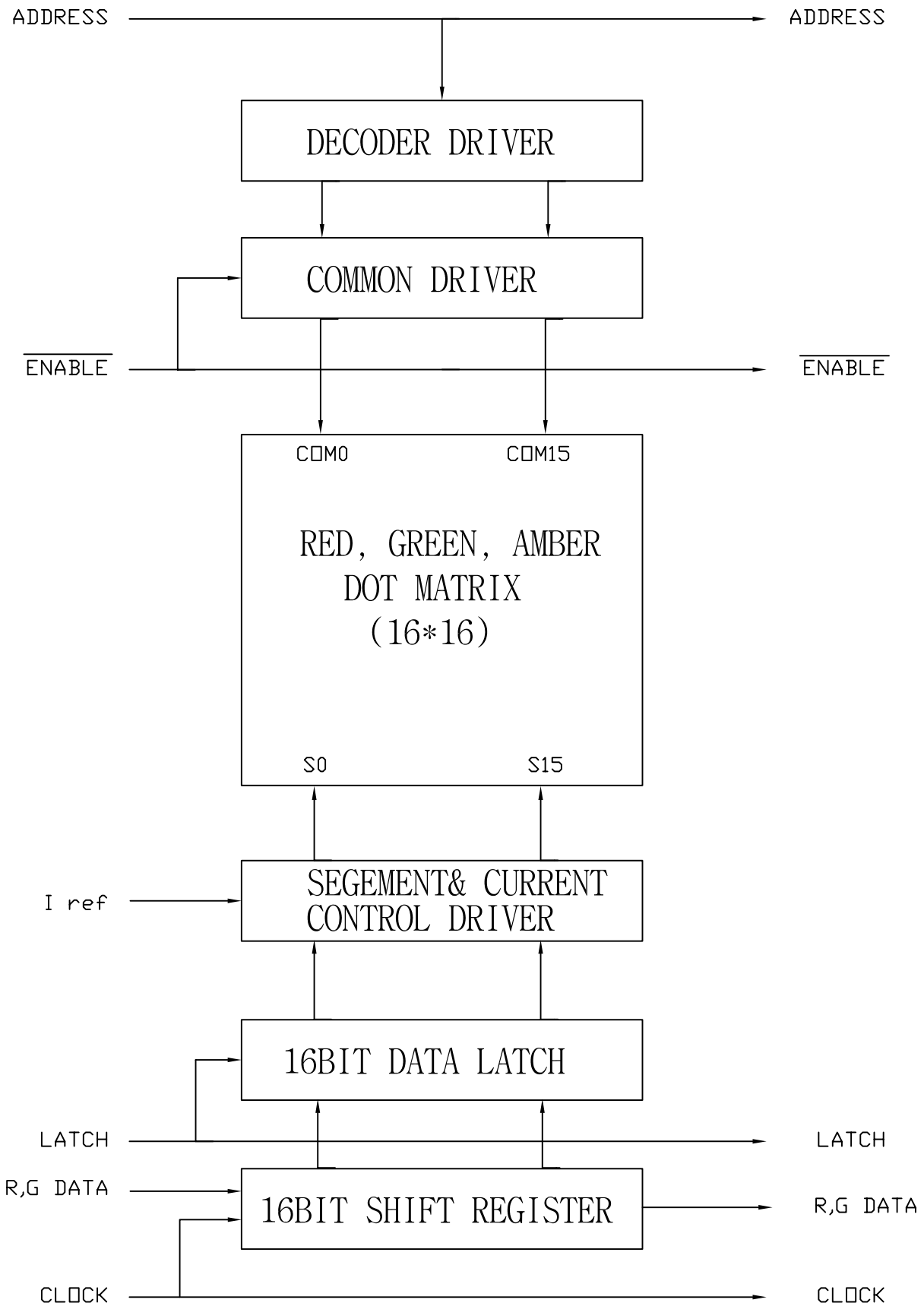

SEOUL Semiconductor

제품명	발행일	REV
SSD-D9696TDM	04.09.15	2
		SHEETS
		7/8

13. 취급및 설치시 주의사항 (SAFETY)

- 입력 범위 이상의 전원이나 역전압이 LED MODULE에 유입될시는 내부회로가 손상되오니 입력전압 범위를 반드시 지켜주시기 바랍니다.
- Backward voltage or overvoltage flows in the LED module can damage the internal circuits. Please operate the module under the permitted scope of voltage supply.
- 높은 습도나 누수에 의해 LED MODULE의 고장 원인이 될수 있습니다.
- High humidity and leak can damage LED module.
- DISPLAY PANEL의 수가 많을경우 및 배기시설이 양호하지 않을 경우에는 LED 발열에의한 MODULE의 손상과 오동작이 발생될수 있으므로 필요시 COOLING FAN을 설치하시기 바랍니다.
- Install a cooling fan for cooling out the LED module in order to avoid damage or operateing failure caused by the heat when many display panels are attached to one board or the module is operated under ill-ventilated conditions.
- LED DOT MATRIX MODULE에 충격및 진동을 가할 경우 DOT불량, 단선등의 원인이 될수 있으므로 삼가하여 주시기 바랍니다.
- LED Module could be damaged or broken by a shock or collision.
- LED MODULE에 찍힘이나 긁힘이 발생하지 않도록 주의하시기 바랍니다.
- Be careful not to scratch or impact the LED Module.
- MODULE을 취급, 보관할경우 정전기 방지 포장을 하여 주십시오.
- Treat or keep under the condtion of static electricity-proof packing.
- Twiste cable 또는 Shield wire는 고주파 잡음으로 부터 module을 보호하여 안정된 동작을 할수 있으므로 필히 사용 하십시오.
- It is recommended to use twist cable or shielded wire to protect the module from high-frequency nosie and to secure stable operation.

 SEOUL Semiconductor	제품명	발행일	REV
	SSD-D9696TDM	04.09.15	2
			SHEETS
			8 / 8