

### PHASE CONTROL THYRISTORS

### Hockey Puk Version

#### Features

- Center amplifying gate
- Metal case with ceramic insulator
- International standard case TO-200AB (E-PUK)
- Low profile hockey-puk to increase current-carrying capability
- Extended temperature range
- Lead Free

960A

#### Typical Applications

- DC motor controls
- Controlled DC power supplies
- AC controllers

#### Major Ratings and Characteristics

Parameters	ST380CH..C	Units	
$I_{T(AV)}$	960	A	
@ $T_{hs}$	80	°C	
$I_{T(RMS)}$	2220	A	
@ $T_{hs}$	25	°C	
$I_{TSM}$	@ 50Hz	12500	A
	@ 60Hz	13000	A
$I^2t$	@ 50Hz	782	KA <sup>2</sup> s
	@ 60Hz	713	KA <sup>2</sup> s
$V_{DRM}/V_{RRM}$	400 to 600	V	
$t_q$	typical	100	μs
$T_J$	- 40 to 150	°C	

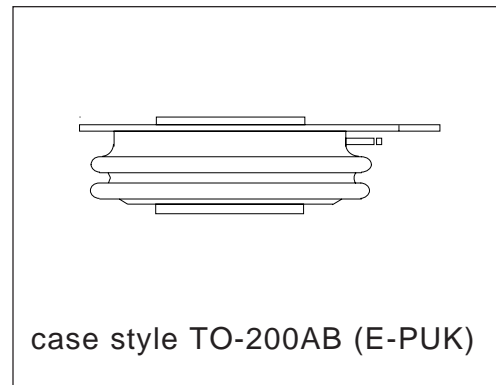

**ELECTRICAL SPECIFICATIONS**

**Voltage Ratings**

Type number	Voltage Code	$V_{DRM}/V_{RRM}$ , max. repetitive peak and off-state voltage V	$V_{RSM}$ , maximum non-repetitive peak voltage V	$I_{DRM}/I_{RRM}$ max. @ $T_J = T_J$ max mA
ST380CH..C	04	400	500	100
	06	600	700	

**On-state Conduction**

Parameter	ST380CH..C	Units	Conditions		
$I_{T(AV)}$ Max. average on-state current @ Heatsink temperature	960 (440)	A	180° conduction, half sine wave double side (single side) cooled		
	80 (110)	°C			
$I_{T(RMS)}$ Max. RMS on-state current	2220	A	DC @ 25°C heatsink temperature double side cooled		
$I_{TSM}$ Max. peak, one-cycle non-repetitive surge current	12500		t = 10ms	No voltage	
	13000		t = 8.3ms	reapplied	
	10500		t = 10ms	100% $V_{RRM}$	
$I^2t$ Maximum $I^2t$ for fusing	11000	KA <sup>2</sup> s	t = 8.3ms	reapplied	Sinusoidal half wave, Initial $T_J = T_J$ max.
	782		t = 10ms	No voltage	
	713		t = 8.3ms	reapplied	
	553		t = 10ms	100% $V_{RRM}$	
	505		t = 8.3ms	reapplied	
$I^2\sqrt{t}$ Maximum $I^2\sqrt{t}$ for fusing	7820	KA <sup>2</sup> √s	t = 0.1 to 10ms, no voltage reapplied ( $16.7\% \times \pi \times I_{T(AV)} < I < \pi \times I_{T(AV)}$ ), $T_J = T_J$ max.		
$V_{T(TO)1}$ Low level value of threshold voltage	0.85	V			
	0.88		$(I > \pi \times I_{T(AV)}), T_J = T_J$ max.		
$r_{t1}$ Low level value of on-state slope resistance	0.25	mΩ	$(16.7\% \times \pi \times I_{T(AV)} < I < \pi \times I_{T(AV)}), T_J = T_J$ max.		
	0.24		$(I > \pi \times I_{T(AV)}), T_J = T_J$ max.		
$V_{TM}$ Max. on-state voltage	1.58	V	$I_{pk} = 2900A, T_J = T_J$ max, $t_p = 10ms$ sine pulse $T_J = 25^\circ C$ , anode supply 12V resistive load		
$I_H$ Maximum holding current	600	mA			
$I_L$ Typical latching current	1000				

**Switching**

Parameter	ST380CH..C	Units	Conditions
di/dt Max. non-repetitive rate of rise of turned-on current	1000	A/μs	Gate drive 20V, 20Ω, $t_r \leq 1\mu s$ $T_J = T_J$ max, anode voltage $\leq 80\% V_{DRM}$
$t_d$ Typical delay time	1.0	μs	Gate current 1A, $di_g/dt = 1A/\mu s$ $V_d = 0.67\% V_{DRM}, T_J = 25^\circ C$
$t_q$ Typical turn-off time	100		$I_{TM} = 550A, T_J = T_J$ max, $di/dt = 40A/\mu s, V_R = 50V$ $dv/dt = 20V/\mu s, \text{Gate } 0V \text{ } 100\Omega, t_p = 500\mu s$

**Blocking**

Parameter	ST380CH..C	Units	Conditions
dv/dt Maximum critical rate of rise of	500 off-state voltage	V/ $\mu$ s	$T_J = T_J$ max. linear to 80% rated $V_{DRM}$
$I_{RRM}$ $I_{DRM}$ Max. peak reverse and off-state leakage current	100	mA	$T_J = T_J$ max, rated $V_{DRM}/V_{RRM}$ applied

**Triggering**

Parameter	ST380CH..C	Units	Conditions
$P_{GM}$ Maximum peak gate power	10.0	W	$T_J = T_J$ max, $t_p \leq 5$ ms
$P_{G(AV)}$ Maximum average gate power	2.0		$T_J = T_J$ max, $f = 50$ Hz, $d\% = 50$
$I_{GM}$ Max. peak positive gate current	3.0	A	$T_J = T_J$ max, $t_p \leq 5$ ms
$+V_{GM}$ Maximum peak positive gate voltage	20	V	$T_J = T_J$ max, $t_p \leq 5$ ms
$-V_{GM}$ Maximum peak negative gate voltage	5.0		
$I_{GT}$ DC gate current required to trigger	TYP.	MAX.	$T_J = -40^\circ\text{C}$ $T_J = 25^\circ\text{C}$ $T_J = 150^\circ\text{C}$ Max. required gate trigger/ current/ voltage are the lowest value which will trigger all units 12V anode-to-cathode applied
	200	-	
	100	200	
$V_{GT}$ DC gate voltage required to trigger	2.5	-	$T_J = -40^\circ\text{C}$ $T_J = 25^\circ\text{C}$ $T_J = 150^\circ\text{C}$
	1.8	3.0	
	1.0	-	
$I_{GD}$ DC gate current not to trigger	10	mA	$T_J = T_J$ max Max. gate current/voltage not to trigger is the max. value which will not trigger any unit with rated $V_{DRM}$ anode-to-cathode applied
$V_{GD}$ DC gate voltage not to trigger	0.25	V	

**Thermal and Mechanical Specification**

Parameter	ST380CH..C	Units	Conditions
$T_J$ Max. operating temperature range	-40 to 150	$^\circ\text{C}$	
$T_{stg}$ Max. storage temperature range	-40 to 150		
$R_{thJ-hs}$ Max. thermal resistance, junction to heatsink	0.09	K/W	DC operation single side cooled
	0.04		DC operation double side cooled
$R_{thC-hs}$ Max. thermal resistance, case to heatsink	0.02	K/W	DC operation single side cooled
	0.01		DC operation double side cooled
F Mounting force, $\pm 10\%$	9800	N	
	(1000)	(Kg)	
wt Approximate weight	83	g	
Case style	TO-200AB (E-PUK)		See Outline Table

**$\Delta R_{thJ-hs}$  Conduction**

(The following table shows the increment of thermal resistance  $R_{thJ-hs}$  when devices operate at different conduction angles than DC)

Conduction angle	Sinusoidal conduction		Rectangular conduction		Units	Conditions
	Single Side	Double Side	Single Side	Double Side		
180°	0.010	0.011	0.007	0.007	K/W	$T_J = T_{J \text{ max.}}$
120°	0.012	0.012	0.012	0.013		
90°	0.015	0.015	0.016	0.017		
60°	0.022	0.022	0.023	0.023		
30°	0.036	0.036	0.036	0.037		

**Ordering Information Table**

**Device Code**

ST	38	0	CH	06	C	1		PbF
①	②	③	④	⑤	⑥	⑦	⑧	⑨

- 1** - Thyristor
- 2** - Essential part number
- 3** - 0= Converter grade
- 4** - CH = Ceramic Puk, High temperature
- 5** - Voltage code: Code x 100 =  $V_{RRM}$  (See Voltage Rating Table)
- 6** - C = Puk Case TO-200AB (E-PUK)
- 7** - 0 = Eyelet terminals (Gate and Auxiliary Cathode Unsoldered Leads)  
 1 = Fast-on terminals (Gate and Auxiliary Cathode Unsoldered Leads)  
 2 = Eyelet terminals (Gate and Auxiliary Cathode Soldered Leads)  
 3 = Fast-on terminals (Gate and Auxiliary Cathode Soldered Leads)
- 8** - Critical dv/dt: None = 500V/ $\mu$ sec (Standard selection)  
 L = 1000V/ $\mu$ sec (Special selection)
- 9** - Lead Free

Outline Table

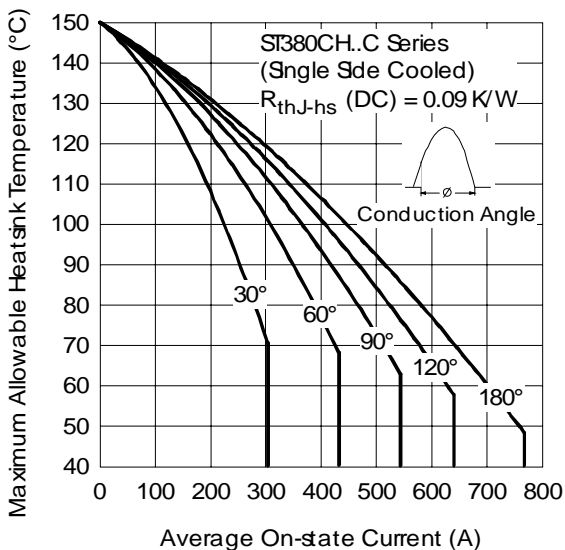
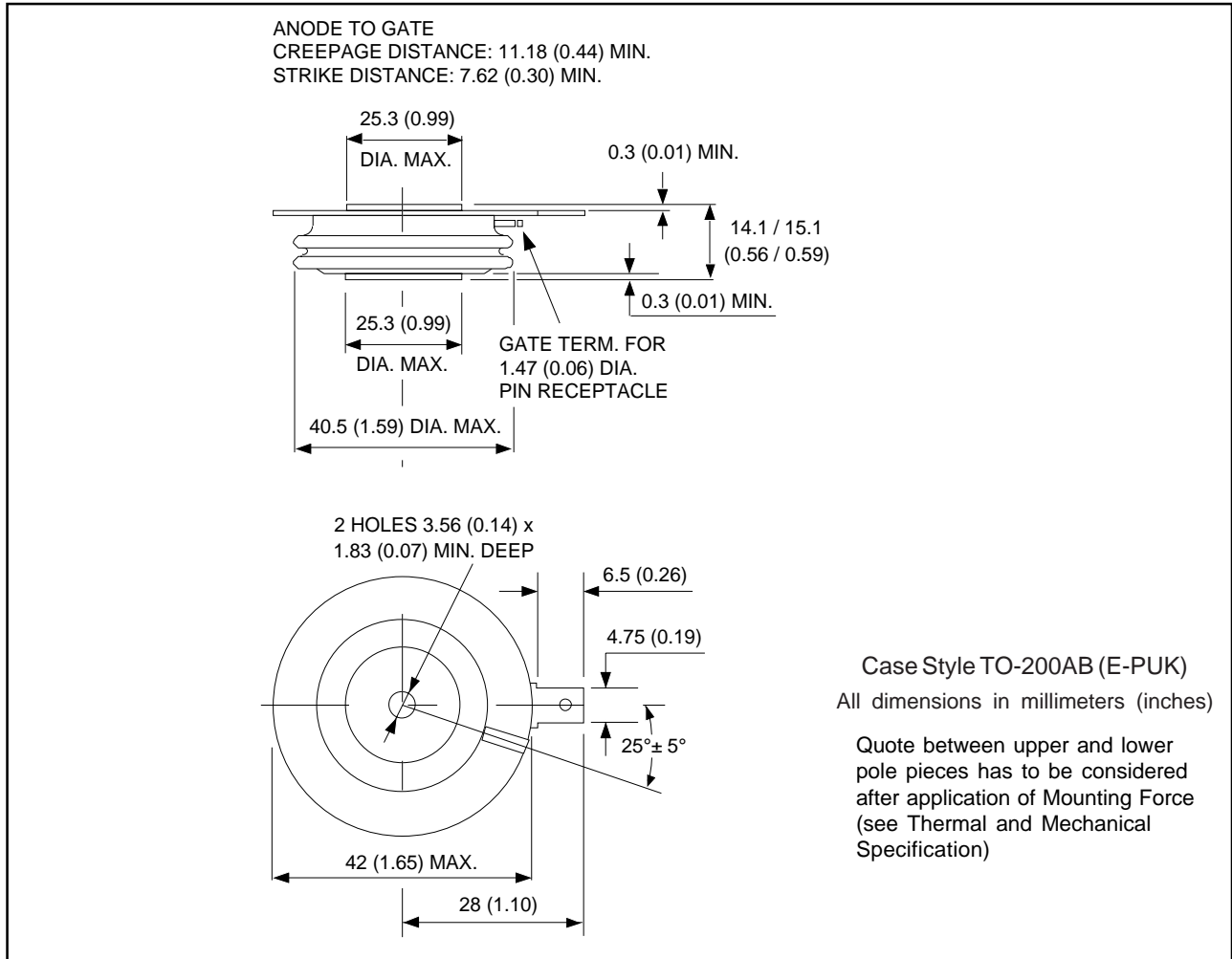

Fig. 1 - Current Ratings Characteristics

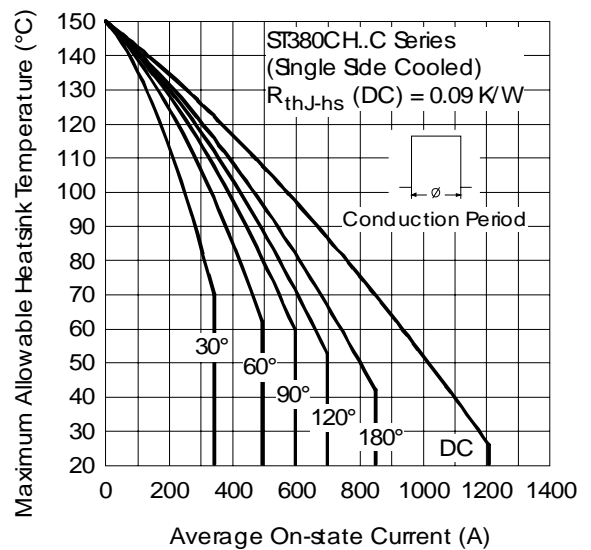

Fig. 2 - Current Ratings Characteristics

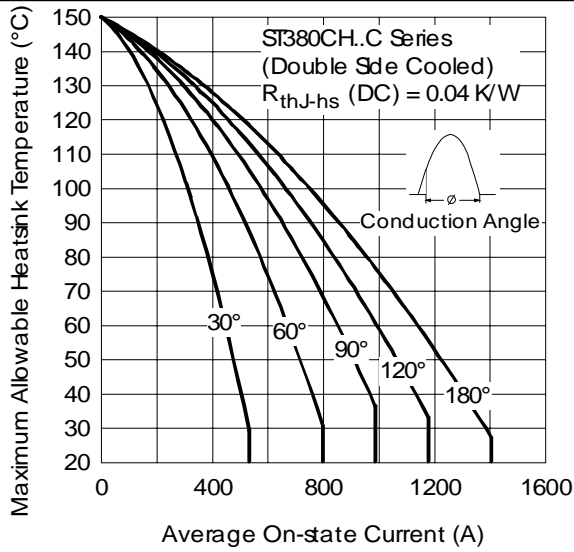

Fig. 3 - Current Ratings Characteristics

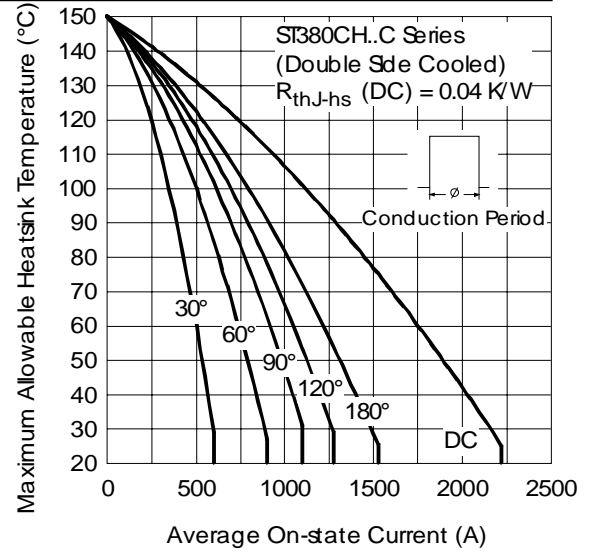

Fig. 4 - Current Ratings Characteristics

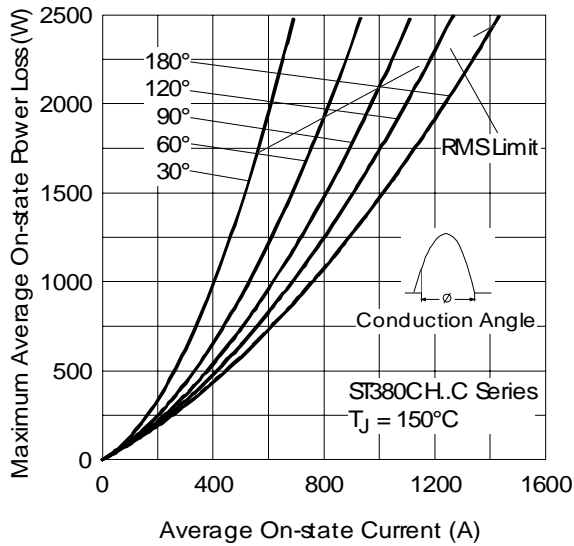

Fig. 5 - On-state Power Loss Characteristics

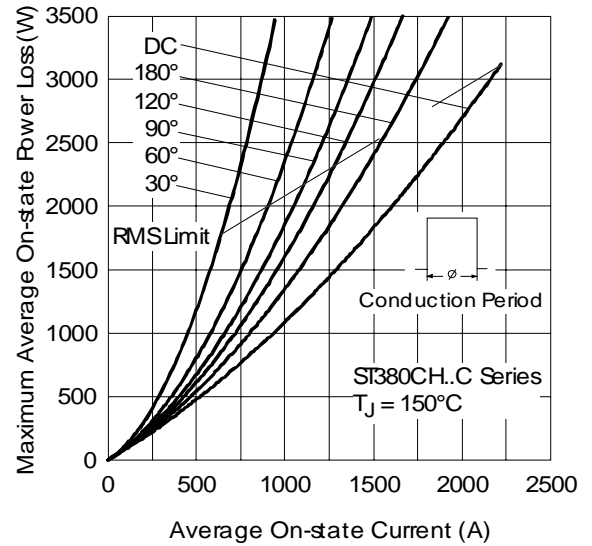

Fig. 6 - On-state Power Loss Characteristics

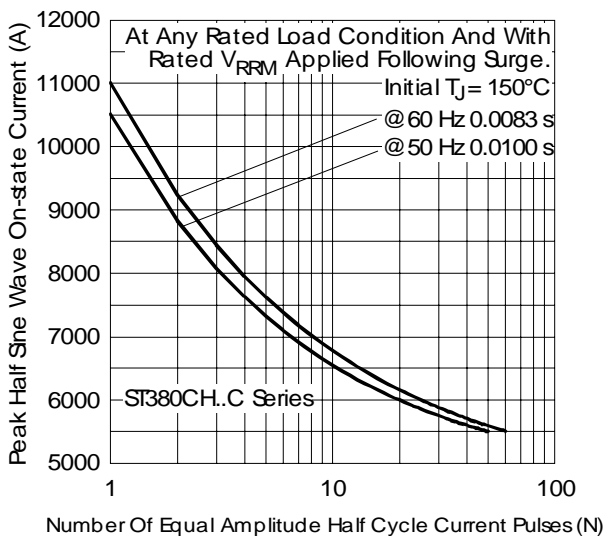

Fig. 7 - Maximum Non-Repetitive Surge Current Single and Double Side Cooled

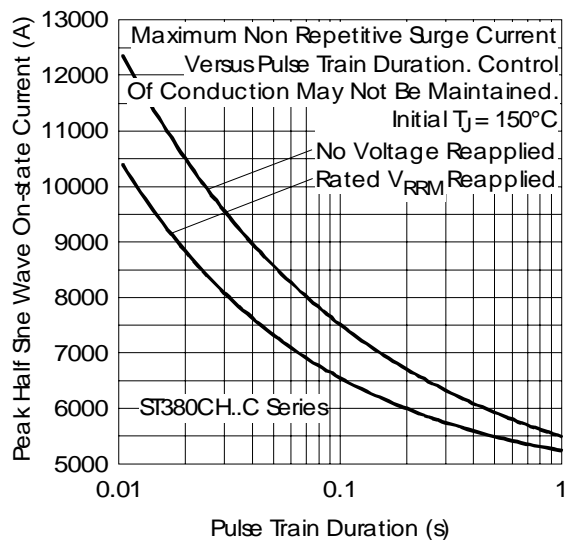

Fig. 8 - Maximum Non-Repetitive Surge Current Single and Double Side Cooled

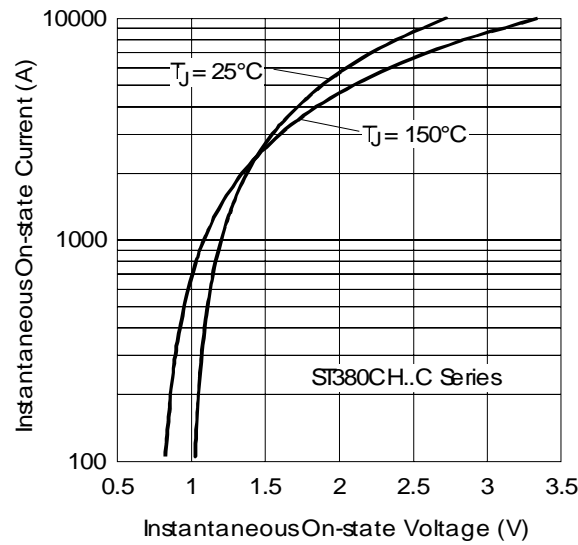

Fig. 9 - On-state Voltage Drop Characteristics

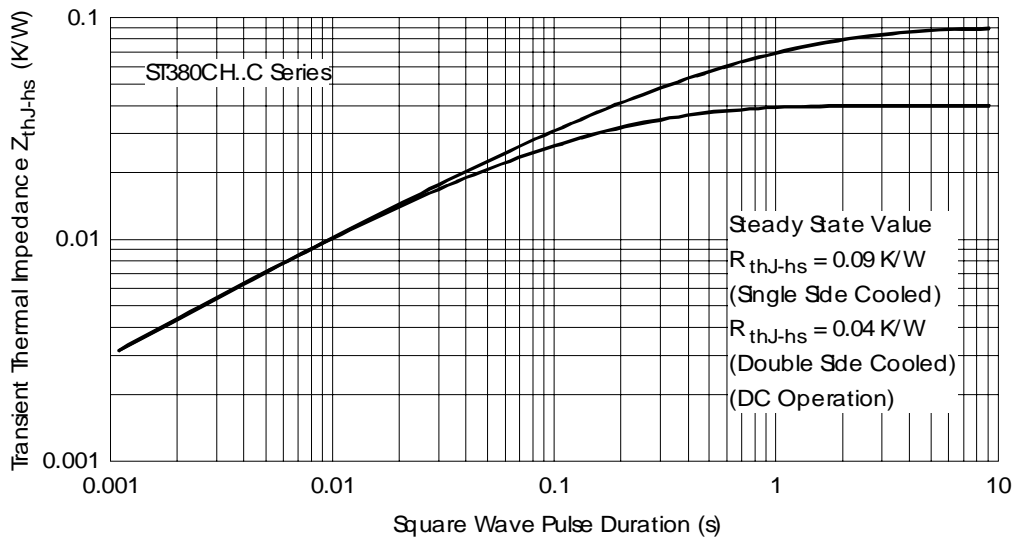

Fig. 10 - Thermal Impedance  $Z_{thJ-hs}$  Characteristics

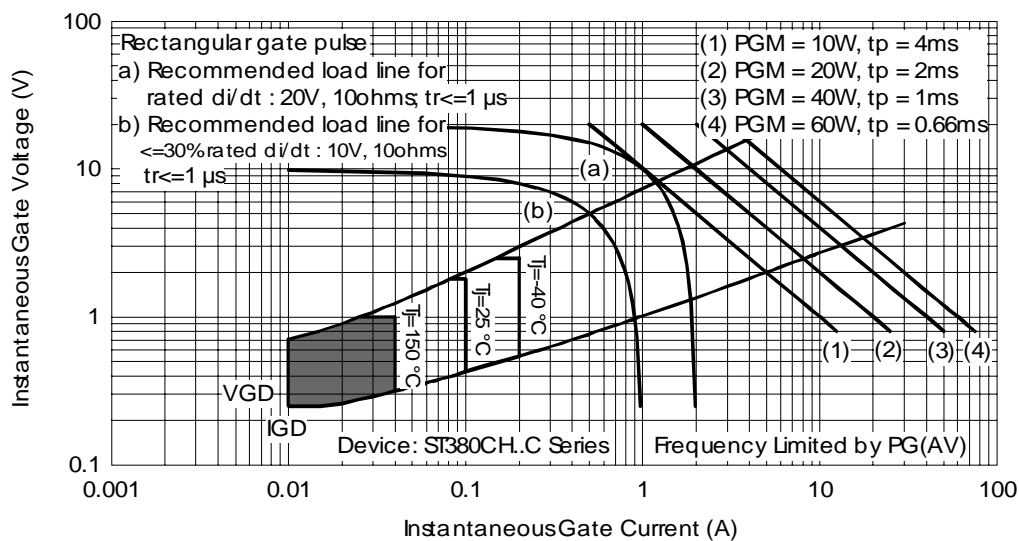

Fig. 11 - Gate Characteristics

## ST380CHPbF Series

Bulletin I25227 09/06

International  
**IOR** Rectifier

---

Data and specifications subject to change without notice.  
This product has been designed and qualified for Industrial Level.  
Qualification Standards can be found on IR's Web site.

International  
**IOR** Rectifier

**IR WORLD HEADQUARTERS:** 233 Kansas St., El Segundo, California 90245, USA Tel: (310) 252-7105  
TAC Fax: (310) 252-7309

Visit us at [www.irf.com](http://www.irf.com) for sales contact information. 09/06