



STGB20NB37LZ

N-CHANNEL CLAMPED 20A - D²PAK INTERNALLY CLAMPED PowerMESH™ IGBT

TYPE	V _{CES}	V _{CE(sat)}	I _c
STGB20NB37LZ	CLAMPED	< 2.0 V	20 A

- POLYSILICON GATE VOLTAGE DRIVEN
- LOW THRESHOLD VOLTAGE
- LOW ON-VOLTAGE DROP
- LOW GATE CHARGE
- HIGH CURRENT CAPABILITY
- HIGH VOLTAGE CLAMPING FEATURE
- ADD SUFFIX "T4" FOR ORDERING IN TAPE & REEL

DESCRIPTION

Using the latest high voltage technology based on a patented strip layout, STMicroelectronics has designed an advanced family of IGBTs, the PowerMESH™ IGBTs, with outstanding performances. The built in collector-gate zener exhibits a very precise active clamping while the gate-emitter zener supplies an ESD protection.

APPLICATIONS

- AUTOMOTIVE IGNITION

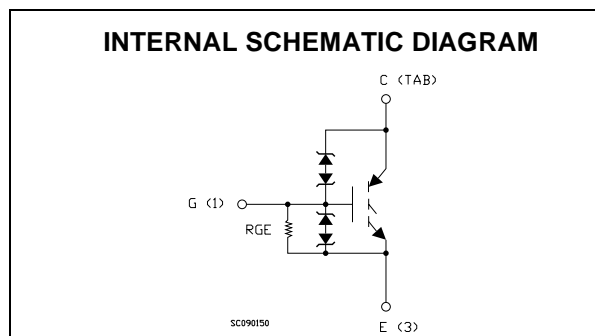
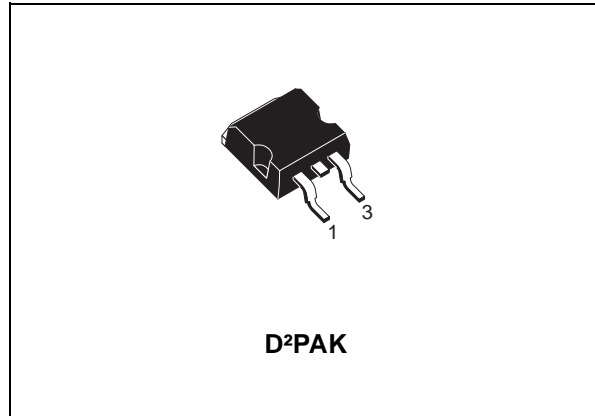

ORDERING INFORMATION

SALES TYPE	MARKING	PACKAGE	PACKAGING
STGB20NB37LZT4	GB20NB37LZ	D ² PAK	TAPE & REEL

STGB20NB37LZ

ABSOLUTE MAXIMUM RATINGS

Symbol	Parameter	Value	Unit
V_{CES}	Collector-Emitter Voltage ($V_{GS} = 0$)	CLAMPED	V
V_{ECR}	Emitter-Collector Voltage	20	V
V_{GE}	Gate-Emitter Voltage	CLAMPED	V
I_C	Collector Current (continuous) at $T_C = 25^\circ\text{C}$	40	A
I_C	Collector Current (continuous) at $T_C = 100^\circ\text{C}$	20	A
$I_{CM} (\blacksquare)$	Collector Current (pulsed)	80	A
E_{as}	Single Pulse Energy $T_c = 25^\circ\text{C}$	700	mJ
P_{TOT}	Total Dissipation at $T_C = 25^\circ\text{C}$	200	W
	Derating Factor	1.33	W/°C
E_{SD}	ESD (Human Body Model)	8	KV
T_{stg}	Storage Temperature	-55 to 175	°C
T_j	Max. Operating Junction Temperature		

(■) Pulse width limited by safe operating area

THERMAL DATA

Rthj-case	Thermal Resistance Junction-case Max	0.75	°C/W
Rthj-amb	Thermal Resistance Junction-ambient Max	62.5	°C/W

ELECTRICAL CHARACTERISTICS ($T_{CASE} = 25^\circ\text{C}$ UNLESS OTHERWISE SPECIFIED) OFF

Symbol	Parameter	Test Conditions	Min.	Typ.	Max.	Unit
$BV_{(CES)}$	Clamped Voltage	$I_C = 2\text{ mA}, V_{GE} = 0, T_C = -40^\circ\text{C}$		405		V
		$I_C = 2\text{ mA}, V_{GE} = 0, T_C = 25^\circ\text{C}$	375	400	425	V
		$I_C = 2\text{ mA}, V_{GE} = 0, T_C = 150^\circ\text{C}$		395		V
$BV_{(ECR)}$	Emitter Collector Break-down Voltage	$I_C = 75\text{ mA}, T_C = 25^\circ\text{C}$	20	28		V
BV_{GE}	Gate Emitter Break-down Voltage	$I_G = \pm 2\text{ mA}$	12	14	16	V
I_{CES}	Collector cut-off Current ($V_{GE} = 0$)	$V_{CE} = 15\text{ V}, V_{GE} = 0, T_C = 150^\circ\text{C}$			10	μA
		$V_{CE} = 200\text{ V}, V_{GE} = 0, T_C = 150^\circ\text{C}$			100	μA
I_{GES}	Gate-Emitter Leakage Current ($V_{CE} = 0$)	$V_{GE} = \pm 10\text{ V}, V_{CE} = 0$	± 300	± 660	± 1000	μA
R_{GE}	Gate Emitter Resistance		10	15	30	K Ω

ON (*)

Symbol	Parameter	Test Conditions	Min.	Typ.	Max.	Unit
$V_{GE(th)}$	Gate Threshold Voltage	$V_{CE} = V_{GE}, I_C = 250\mu\text{A}, T_C = -40^\circ\text{C}$	1.2			V
		$V_{CE} = V_{GE}, I_C = 250\mu\text{A}, T_C = 25^\circ\text{C}$	1	1.4	2	V
		$V_{CE} = V_{GE}, I_C = 250\mu\text{A}, T_C = 150^\circ\text{C}$	0.6			V
$V_{CE(SAT)}$	Collector-Emitter Saturation Voltage	$V_{CE} = 4.5\text{ V}, I_C = 10\text{ A}, T_C = 25^\circ\text{C}$		1.1	1.8	V
		$V_{CE} = 4.5\text{ V}, I_C = 10\text{ A}, T_C = 150^\circ\text{C}$		1.0	1.7	V
		$V_{CE} = 4.5\text{ V}, I_C = 20\text{ A}, T_C = 25^\circ\text{C}$		1.35	2.0	V
		$V_{CE} = 4.5\text{ V}, I_C = 20\text{ A}, T_C = 150^\circ\text{C}$		1.25	2.0	V

DYNAMIC

Symbol	Parameter	Test Conditions	Min.	Typ.	Max.	Unit
g_{fs} (1)	Forward Transconductance	$V_{CE} = 25 \text{ V}$, $I_C = 20 \text{ A}$		35		S
C_{ies}	Input Capacitance	$V_{CE} = 25 \text{ V}$, $f = 1 \text{ MHz}$, $V_{GE} = 0$		2300		pF
C_{oes}	Output Capacitance			165		pF
C_{res}	Reverse Transfer Capacitance			28		pF
Q_g	Gate Charge	$V_{CE} = 280 \text{ V}$, $I_C = 20 \text{ A}$, $V_{GE} = 5 \text{ V}$		51		nC

FUNCTIONAL CHARACTERISTICS

Symbol	Parameter	Test Conditions	Min.	Typ.	Max.	Unit
II	Latching Current	$V_{Clamp} = 250 \text{ V}$, $T_C = 125 \text{ }^\circ\text{C}$ $R_{GOFF} = 1 \text{ K}\Omega$, $V_{GE} = 4.5 \text{ V}$		40		A
U.I.S.	Functional Test Open Secondary Coil	$R_{GOFF} = 1 \text{ K}\Omega$, $L = 1.6 \text{ mH}$, $T_C = 125 \text{ }^\circ\text{C}$		20		A

SWITCHING ON

Symbol	Parameter	Test Conditions	Min.	Typ.	Max.	Unit
$t_{d(on)}$	Turn-on Delay Time	$V_{CC} = 250 \text{ V}$, $I_C = 20 \text{ A}$ $R_G = 1 \text{ K}\Omega$, $V_{GE} = 4.5 \text{ V}$		2.3		μs
t_r	Rise Time			0.6		μs
$(di/dt)_{on}$	Turn-on Current Slope	$V_{CC} = 250 \text{ V}$, $I_C = 20 \text{ A}$ $R_G = 1 \text{ K}\Omega$, $V_{GE} = 4.5 \text{ V}$		550		A/ μs
E_{on}	Turn-on Switching Losses	$V_{CC} = 250 \text{ V}$, $I_C = 20 \text{ A}$, $T_C = 25 \text{ }^\circ\text{C}$ $R_G = 1 \text{ K}\Omega$, $V_{GE} = 4.5 \text{ V}$, $T_C = 150 \text{ }^\circ\text{C}$		8.8		mJ
					9.2	

SWITCHING OFF

Symbol	Parameter	Test Conditions	Min.	Typ.	Max.	Unit
t_c	Cross-over Time	$V_{CC} = 250 \text{ V}$, $I_C = 20 \text{ A}$, $R_{GE} = 1 \text{ K}\Omega$, $V_{GE} = 4.5 \text{ V}$		4.8		μs
$t_r(V_{off})$	Off Voltage Rise Time			2.6		μs
$t_{d(off)}$	Delay Time			2.0		μs
t_f	Fall Time			11.5		μs
$E_{off(**)}$	Turn-off Switching Loss			11.8		mJ
t_c	Cross-over Time	$V_{CC} = 250 \text{ V}$, $I_C = 20 \text{ A}$, $R_{GE} = 1 \text{ K}\Omega$, $V_{GE} = 4.5 \text{ V}$ $T_j = 125 \text{ }^\circ\text{C}$		7.8		μs
$t_r(V_{off})$	Off Voltage Rise Time			3.5		μs
$t_{d(off)}$	Delay Time			3.9		μs
t_f	Fall Time			12.0		μs
$E_{off(**)}$	Turn-off Switching Loss			17.8		mJ

(1) Pulsed: Pulse duration = 300 μs , duty cycle 1.5 %.

(*) Pulse width limited by max. junction temperature.

(**) Losses Include Also the Tail

STGB20NB37LZ

Output Characteristics

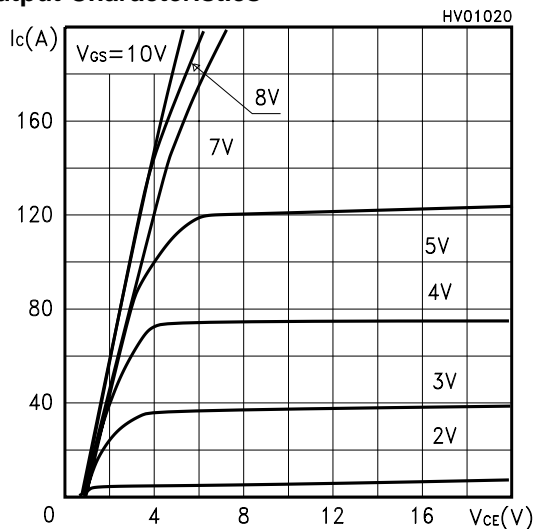

Transfer Characteristics

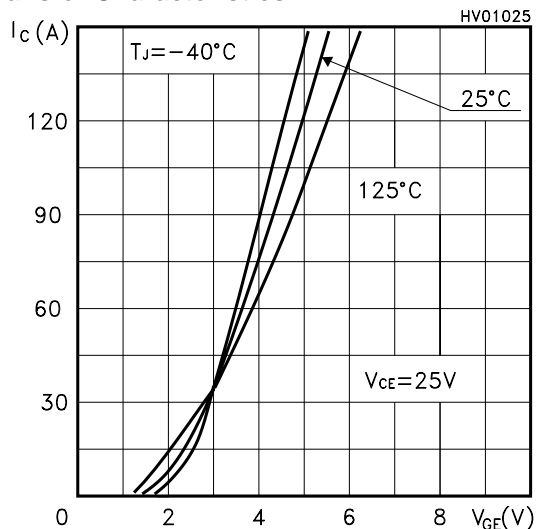

Normalized Gate Threshold Voltage vs Temp.

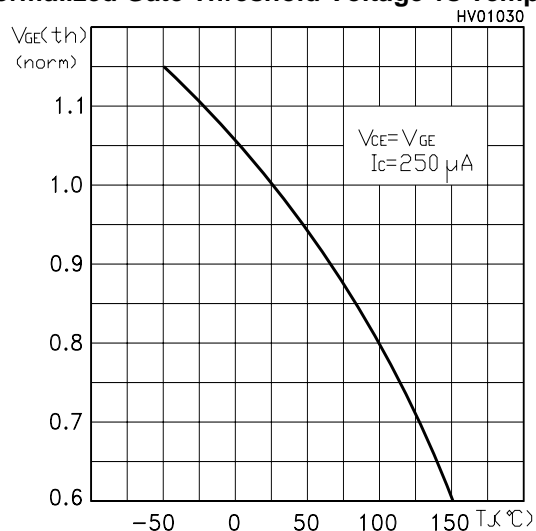

Transconductance

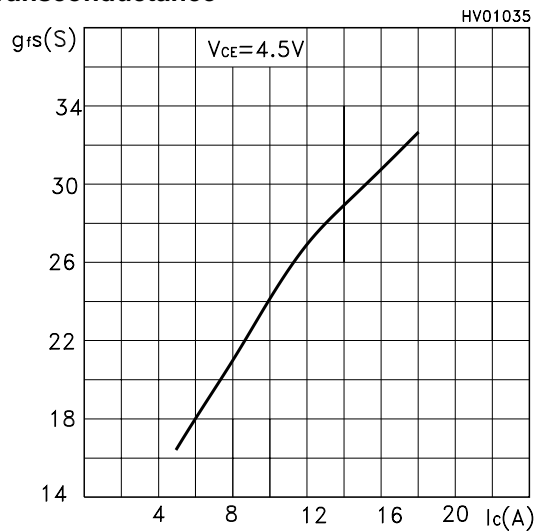

Collector-Emitter On Voltage vs Temperature

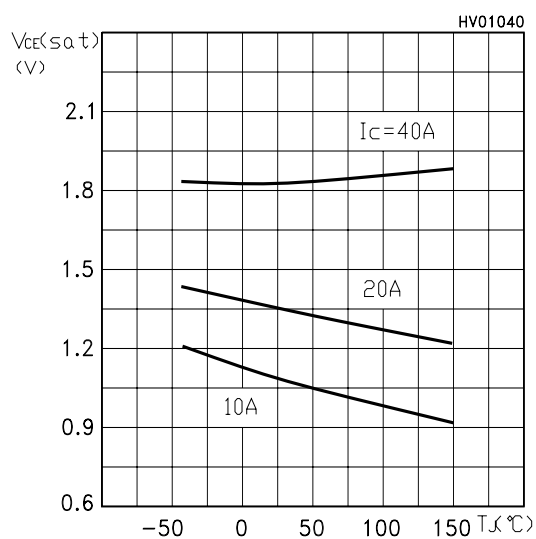

Self Clamped Inductive Switching Energy vs Open Secondary Coil

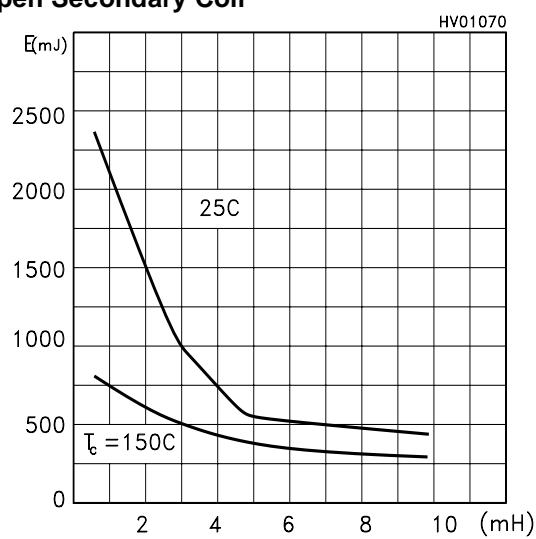

Capacitance Variations

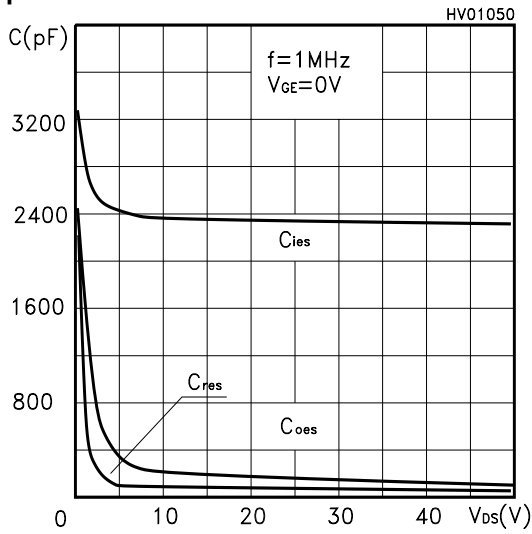

Gate Charge vs Gate-Emitter Voltage

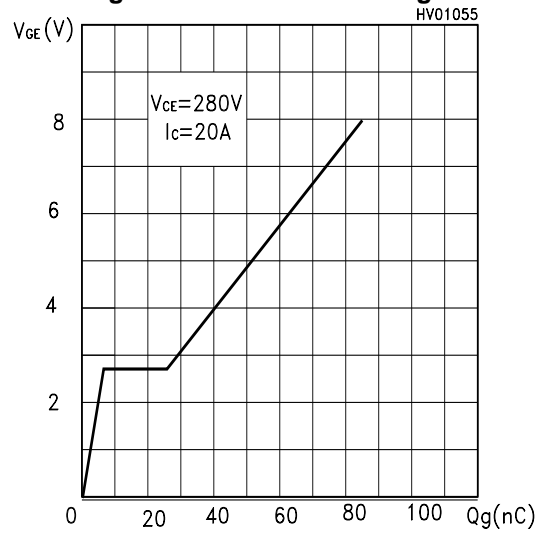

Normalized B_{VGE0} (Zener Gate-Emitter) vs Temperature

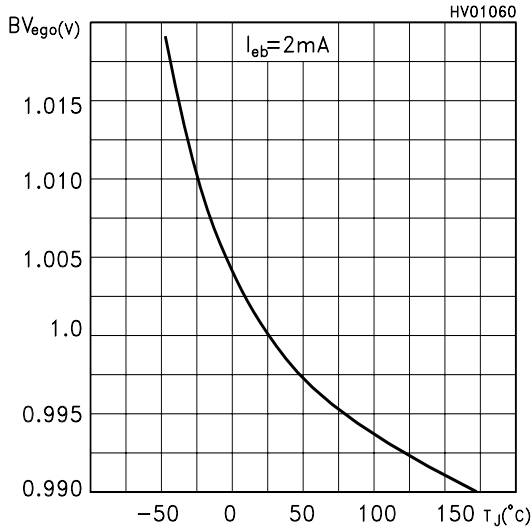

Normalized Clamping Voltage vs Gate Resistance (Inductive Switch Configuration)

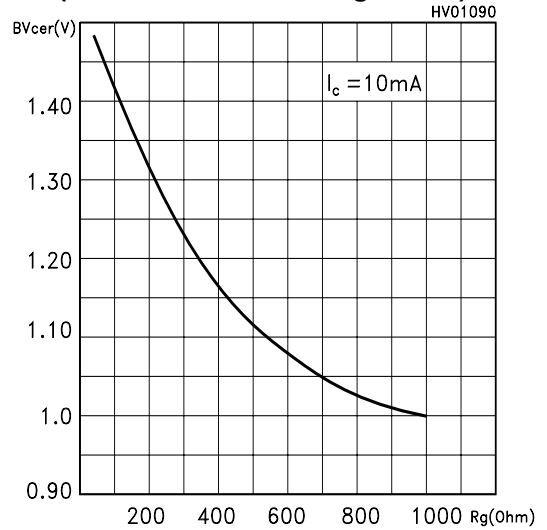

Normalized Clamping Voltage vs Temperature

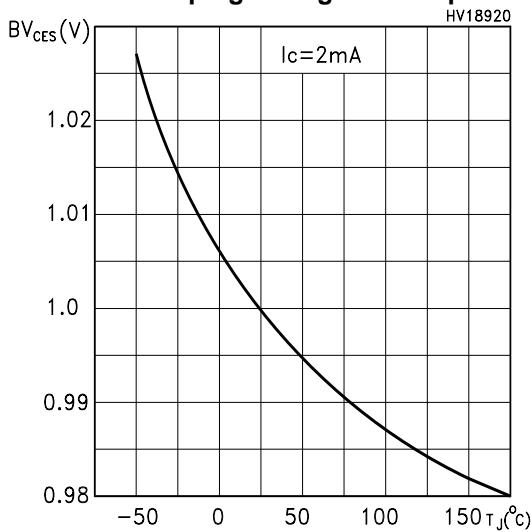

Thermal Impedance

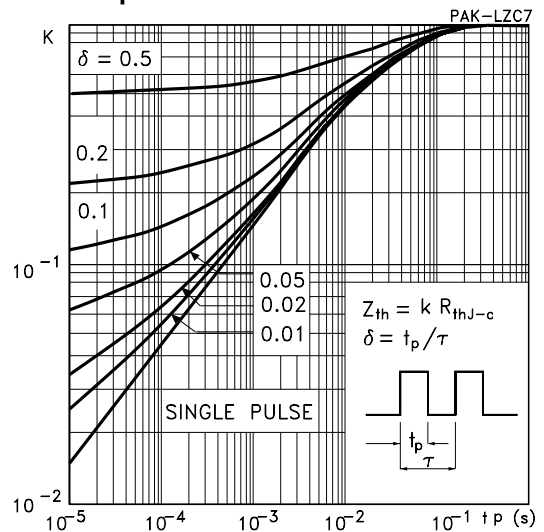

D²PAK MECHANICAL DATA

DIM.	mm.			inch		
	MIN.	TYP	MAX.	MIN.	TYP.	MAX.
A	4.4		4.6	0.173		0.181
A1	2.49		2.69	0.098		0.106
A2	0.03		0.23	0.001		0.009
B	0.7		0.93	0.027		0.036
B2	1.14		1.7	0.044		0.067
C	0.45		0.6	0.017		0.023
C2	1.23		1.36	0.048		0.053
D	8.95		9.35	0.352		0.368
D1		8			0.315	
E	10		10.4	0.393		
E1		8.5			0.334	
G	4.88		5.28	0.192		0.208
L	15		15.85	0.590		0.625
L2	1.27		1.4	0.050		0.055
L3	1.4		1.75	0.055		0.068
M	2.4		3.2	0.094		0.126
R		0.4			0.015	
V2	0°		8°			

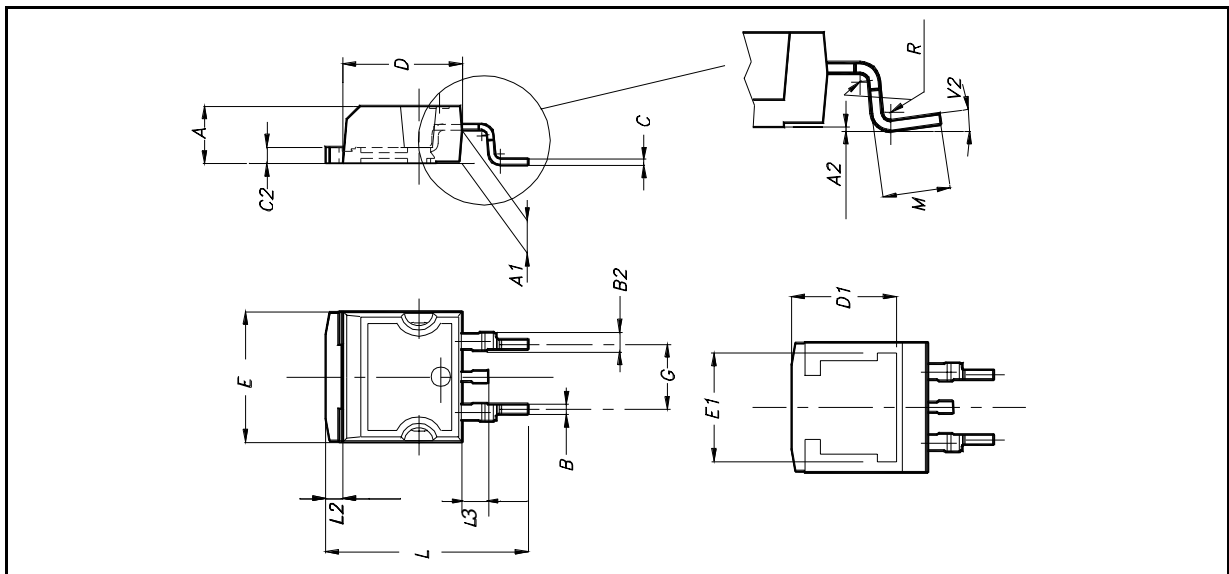

D²PAK FOOTPRINT

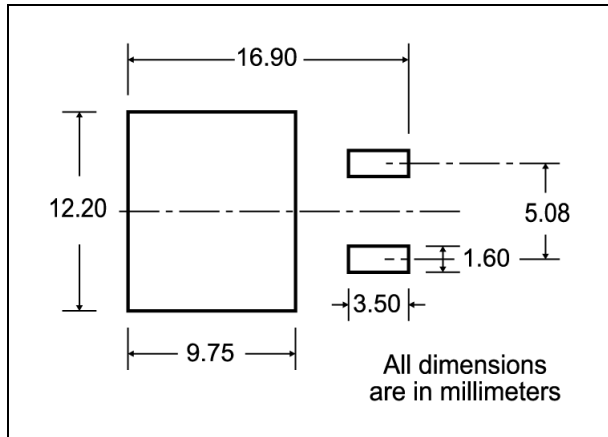

TUBE SHIPMENT (no suffix)*

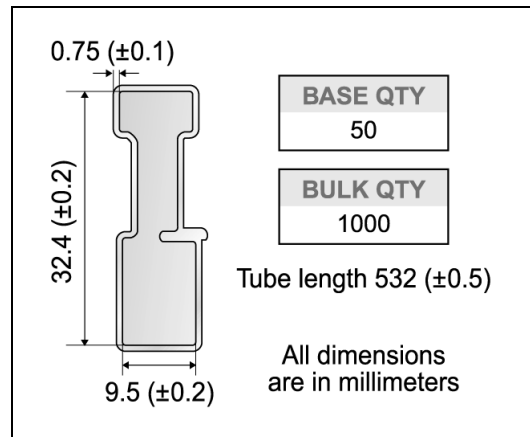

TAPE AND REEL SHIPMENT (suffix "T4")*

TAPE MECHANICAL DATA

DIM.	mm		inch	
	MIN.	MAX.	MIN.	MAX.
A0	10.5	10.7	0.413	0.421
B0	15.7	15.9	0.618	0.626
D	1.5	1.6	0.059	0.063
D1	1.59	1.61	0.062	0.063
E	1.65	1.85	0.065	0.073
F	11.4	11.6	0.449	0.456
K0	4.8	5.0	0.189	0.197
P0	3.9	4.1	0.153	0.161
P1	11.9	12.1	0.468	0.476
P2	1.9	2.1	0.075	0.082
R	50		1.574	
T	0.25	0.35	0.0098	0.0137
W	23.7	24.3	0.933	0.956

REEL MECHANICAL DATA

DIM.	mm		inch	
	MIN.	MAX.	MIN.	MAX.
A		330		12.992
B	1.5		0.059	
C	12.8	13.2	0.504	0.520
D	20.2		0.795	
G	24.4	26.4	0.960	1.039
N	100		3.937	
T		30.4		1.197

BASE QTY	BULK QTY
1000	1000

10 pitches cumulative tolerance on tape +/- 0.2 mm

TRAILER (TRL)

FEED DIRECTION

Bending radius

Information furnished is believed to be accurate and reliable. However, STMicroelectronics assumes no responsibility for the consequences of use of such information nor for any infringement of patents or other rights of third parties which may result from its use. No license is granted by implication or otherwise under any patent or patent rights of STMicroelectronics. Specifications mentioned in this publication are subject to change without notice. This publication supersedes and replaces all information previously supplied. STMicroelectronics products are not authorized for use as critical components in life support devices or systems without express written approval of STMicroelectronics.

© The ST logo is a registered trademark of STMicroelectronics

© 2003 STMicroelectronics - Printed in Italy - All Rights Reserved
STMicroelectronics GROUP OF COMPANIES

Australia - Brazil - Canada - China - Finland - France - Germany - Hong Kong - India - Israel - Italy - Japan - Malaysia - Malta - Morocco
Singapore - Spain - Sweden - Switzerland - United Kingdom - United States.

© <http://www.st.com>