

SNUBBERLESS TRIAC

FEATURES

- $I_{T(RMS)} = 12\text{ A}$
- $V_{DRM} = V_{RRM} = 400\text{V to } 700\text{V}$
- EXCELLENT SWITCHING PERFORMANCES
- INSULATING VOLTAGE = $1500\text{V}_{(RMS)}$
- U.L. RECOGNIZED : E81734

DESCRIPTION

The T1220/1230W triacs use high performance glass passivated chip technology, housed in a fully molded plastic ISOWATT220AB package.

The SNUBBERLESS™ concept offers suppression of R-C network, and is suitable for applications such as phase control and static switch on inductive and resistive loads.

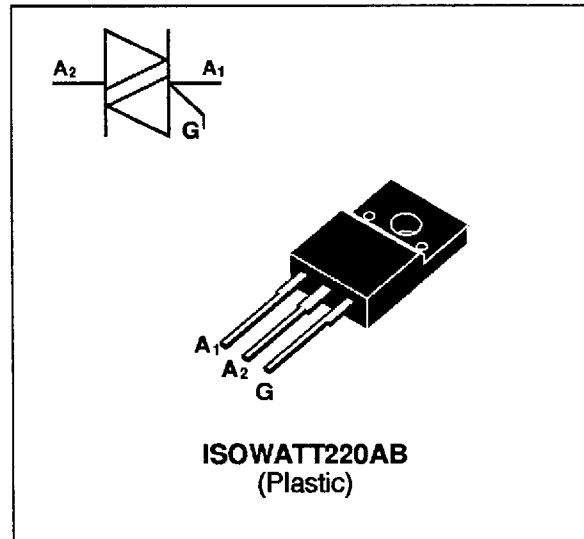

ABSOLUTE RATINGS (limiting values)

Symbol	Parameter		Value	Unit
$I_{T(RMS)}$	RMS on-state current (360° conduction angle)	$T_c = 85\text{ °C}$	12	A
I_{TSM}	Non repetitive surge peak on-state current (T_j initial = 25 °C)	$t_p = 16.7\text{ ms}$ (1 cycle, 60 Hz)	132	A
		$t_p = 10\text{ ms}$ (1/2 cycle, 50 Hz)	155	
I^2t	I^2t Value (half-cycle, 50 Hz)	$t_p = 10\text{ ms}$	120	A^2s
di/dt	Critical rate of rise of on-state current Gate supply : $I_G = 500\text{ mA}$ $dI_G/dt = 1\text{ A}/\mu\text{s}$.	Repetitive $F = 50\text{ Hz}$	20	$\text{A}/\mu\text{s}$
		Non Repetitive	100	
T_{stg} T_j	Storage temperature range Operating junction temperature range		- 40 to + 150 - 40 to + 125	°C
T_l	Maximum lead temperature for soldering during 10s at 4.5 mm from case		260	°C

Symbol	Parameter	T1220 / 1230-xxxW			Unit
		400	600	700	
V_{DRM} V_{RRM}	Repetitive peak off-state voltage $T_j = 125\text{ °C}$	400	600	700	V

T1220W / 1230W

THERMAL RESISTANCES

Symbol	Parameter	Value	Unit
Rth(j-a)	Junction to ambient	50	°C/W
Rth(j-c)	Junction to case for A.C (360° conduction angle)	2.8	°C/W

GATE CHARACTERISTICS (maximum values)

$P_{G(AV)} = 1 \text{ W}$ $P_{GM} = 10 \text{ W}$ ($t_p = 20 \mu\text{s}$) $I_{GM} = 4 \text{ A}$ ($t_p = 20 \mu\text{s}$)

ELECTRICAL CHARACTERISTICS

Symbol	Test Conditions	Quadrant		T1220	T1230	Unit
I_{GT}	$V_D = 12\text{V (DC)}$ $R_L = 33\Omega$ $T_j = 25^\circ\text{C}$	I-II-III	MAX	20	30	mA
V_{GT}	$V_D = 12\text{V (DC)}$ $R_L = 33\Omega$ $T_j = 25^\circ\text{C}$	I-II-III	MAX	1.5		V
V_{GD}	$V_D = V_{DRM}$ $R_L = 3.3\text{k}\Omega$ $T_j = 125^\circ\text{C}$	I-II-III	MIN	0.2		V
t_{gt}	$V_D = V_{DRM}$ $I_G = 500\text{mA}$ $di_G/dt = 3\text{A}/\mu\text{s}$ $T_j = 25^\circ\text{C}$	I-II-III	TYP	2		μs
I_H^*	$I_T = 100\text{mA}$ Gate open $T_j = 25^\circ\text{C}$		MAX	35	50	
V_{TM}^*	$I_{TM} = 17\text{A}$ $t_p = 380\mu\text{s}$ $T_j = 25^\circ\text{C}$		MAX	1.5		V
I_{DRM} I_{RRM}	VDRM rated VRRM rated $T_j = 25^\circ\text{C}$		MAX	10		μA
			MAX	2		mA
dV/dt^*	Linear slope up to $V_D = 67\%V_{DRM}$ Gate open $T_j = 125^\circ\text{C}$		MIN	200	300	$\text{V}/\mu\text{s}$
$(dV/dt)_c^*$	$(di/dt)_c = 6.5 \text{ A/ms}$ (see note) $T_j = 125^\circ\text{C}$		MIN	10	20	$\text{V}/\mu\text{s}$

* For either polarity of electrode A2 voltage with reference to electrode A1.

Note : In usual applications where $(di/dt)_c$ is below 6.5 A/ms, the $(dV/dt)_c$ is always lower than 10V/ μs , and, therefore, it is unnecessary to use a snuber R-C network across T1220W / T1230W triacs.

Fig.1 : Maximum power dissipation versus RMS on-state current.

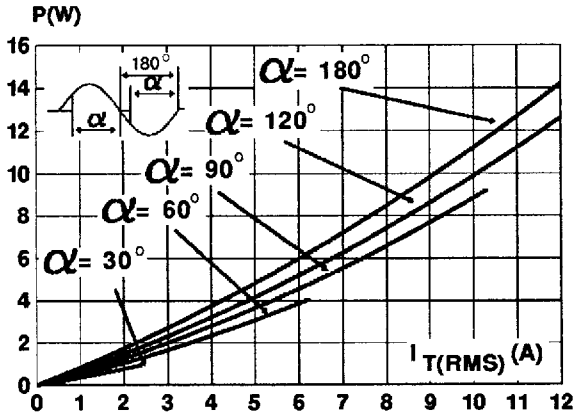

Fig.3 : RMS on-state current versus case temperature.

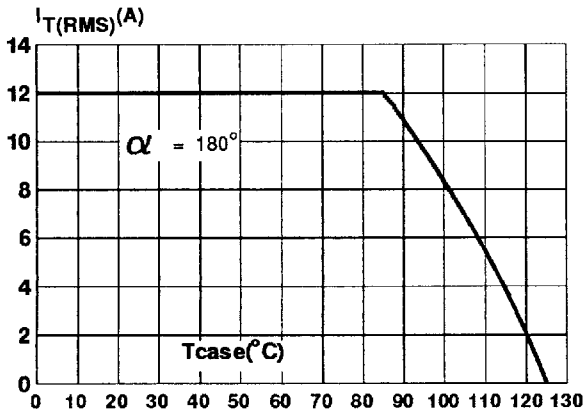

Fig.5 : Relative variation of gate trigger current and holding current versus junction temperature.

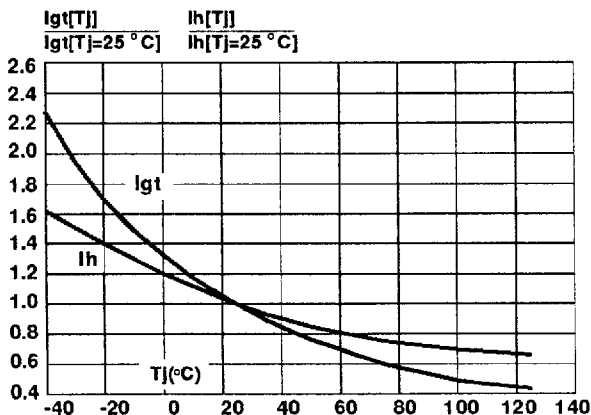

Fig.2 : Correlation between maximum power dissipation and maximum allowable temperature (Tamb and Tcase) for different thermal resistances heatsink + contact.

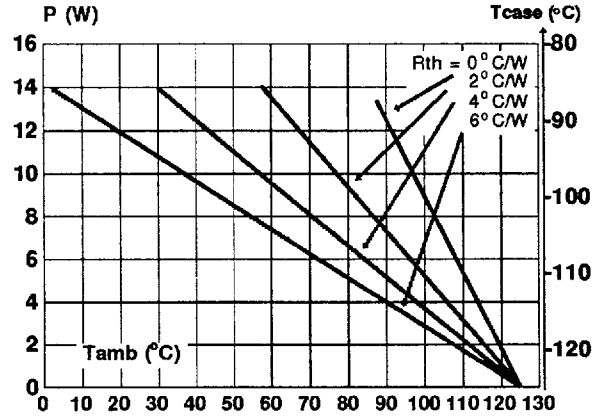

Fig.4 : Thermal transient impedance junction to case and junction to ambient versus pulse duration.

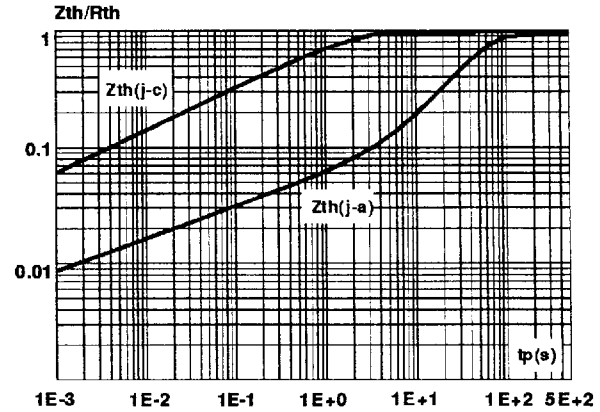
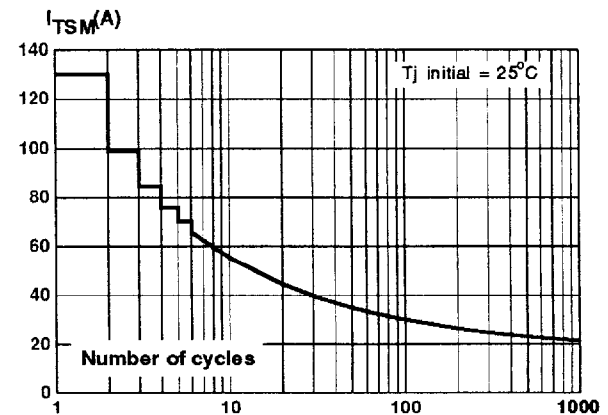

Fig.6 : Non repetitive surge peak on-state current versus number of cycles.



T1220W / 1230W

Fig.7 : Non repetitive surge peak on-state current for a sinusoidal pulse with width : $t_p \leq 10\text{ms}$, and corresponding value of I^2t .

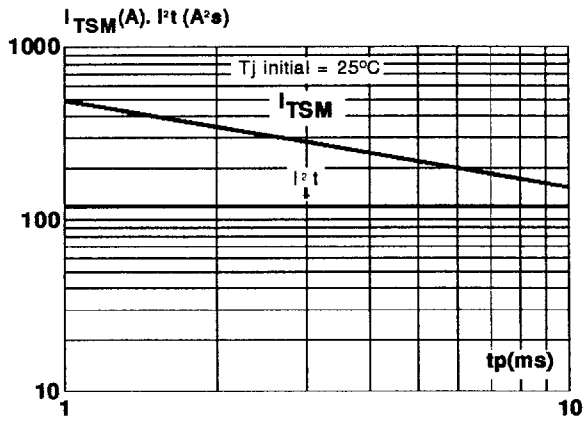
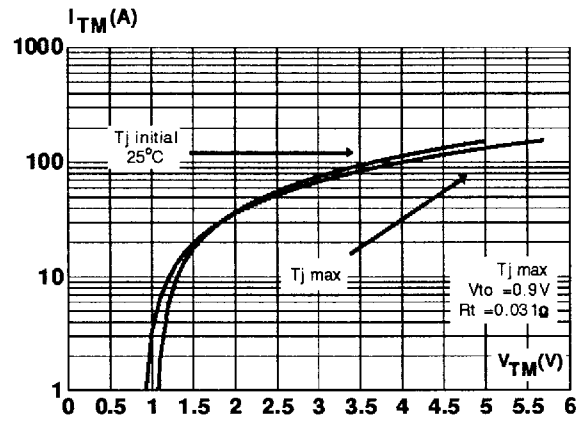
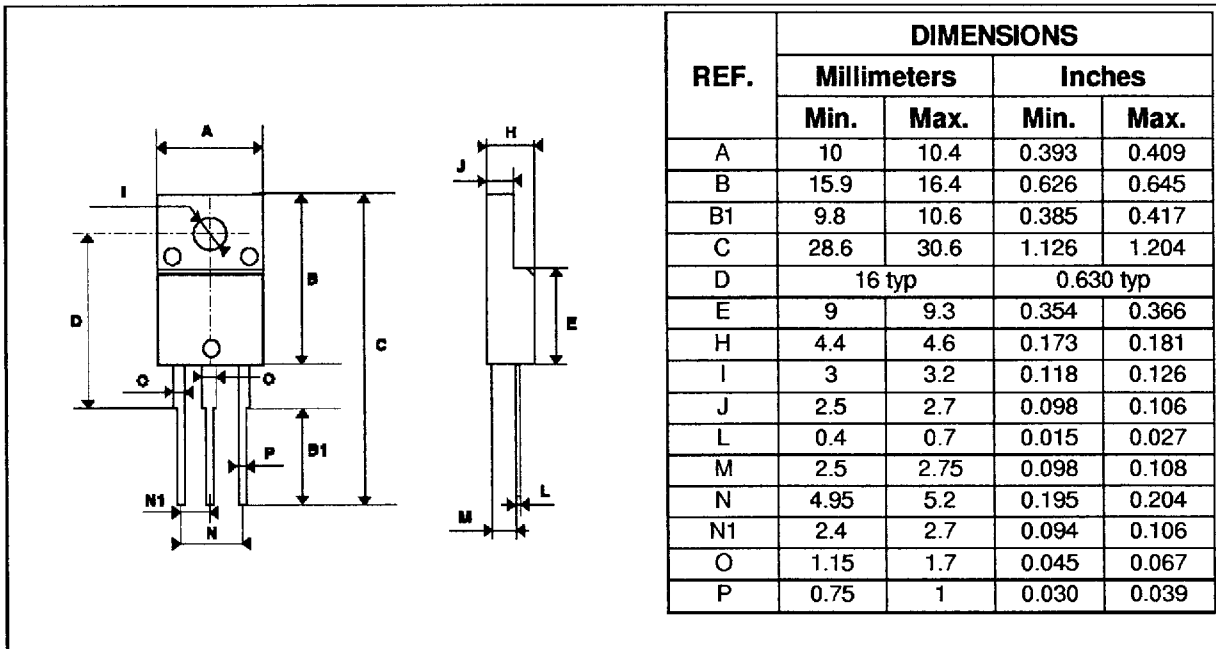

Fig.8 : On-state characteristics (maximum values).



PACKAGE MECHANICAL DATA
ISOWATT220AB

Cooling method : C

Marking : Type number

Weight : 2.1g

Recommended torque value : 0.55 m.N.

Maximum torque value : 0.70 m.N.

Information furnished is believed to be accurate and reliable. However, SGS-THOMSON Microelectronics assumes no responsibility for the consequences of use of such information nor for any infringement of patents or other rights of third parties which may result from its use. No license is granted by implication or otherwise under any patent or patent rights of SGS-THOMSON Microelectronics. Specifications mentioned in this publication are subject to change without notice. This publication supersedes and replaces all information previously supplied. SGS-THOMSON Microelectronics products are not authorized for use as critical components in life support devices or systems without express written approval of SGS-THOMSON Microelectronics.

© 1995 SGS-THOMSON Microelectronics - Printed in Italy - All rights reserved.

SGS-THOMSON Microelectronics GROUP OF COMPANIES

 Australia - Brazil - France - Germany - Hong Kong - Italy - Japan - Korea - Malaysia - Malta - Morocco - The Netherlands -
 Singapore - Spain - Sweden - Switzerland - Taiwan - Thailand - United Kingdom - U.S.A.