



Random-Phase
Triac Driver

DESCRIPTION

The TDM3023 consists of a single input LED optically coupled to a random-phase triac driver. The TDM3023 provides high input-to-output isolation and is designed to drive high-powered triacs. Typical uses include interfacing logic level control signals to equipment powered from 110Vac and 220Vac lines controlling resistive and inductive loads.

FEATURES

- 4 PIN SOP Random-Phase Triac Driver Output
- 400V blocking voltage
- High input-to-output isolation (3750 Vrms)
- High reliability

APPLICATIONS

- Vending Machines
- Motor control
- Solid state relays
- Valve control
- Solenoids
- Traffic Lights

OPTIONS/SUFFIXES

- -TR Tape and Reel Option

MAXIMUM RATINGS

PARAMETER	UNIT	MIN	TYP	MAX
Storage Temperature	°C	-40		125
Operating Temperature	°C	-40		85
Soldering Temperature 10s	°C			260
Transient Input Current	A			1
Reverse Input Control Voltage	V			6
Output Power Dissipation	mW			200
Peak Repetitive Surge Current	A			1
Input Forward Current	mA			50

SCHEMATIC DIAGRAM

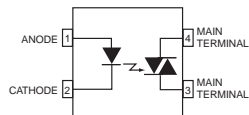



ELECTRICAL CHARACTERISTICS - 25°

PARAMETER	UNIT	MIN	TYP	MAX	TEST CONDITIONS
INPUT SPECIFICATIONS					
LED Forward Voltage	V		1.2	1.5	IF = 10mA
Peak Forward Voltage	V			3.5	IFM= 0.5A
Reverse Leakage Current	uA			10	VR=4V
Trigger Current	mA			5	Main Terminal Voltage =3V
OUTPUT SPECIFICATIONS					
Blocking Voltage	V	400			Io = 1uA
Peak Blocking Current	nA			10	VDRM=Rated
Holding Current	μ A		200		
On-State Voltage	V		1.6	3	ITM= 100mA
COUPLED SPECIFICATIONS					
Critical rate of rise Off-State Voltage	V/us	100			dv/dt=0.63Vmax/RC (Refer to note below)
Isolation Resistance	Gohm	50			DC500V
Isolation Voltage T=1 Minute	Vrms	3750			
Turn-on time	μS			100	VD=6V, RL=100ohm, IF=20mA

Critical Rate of Rise DVIDT test circuit

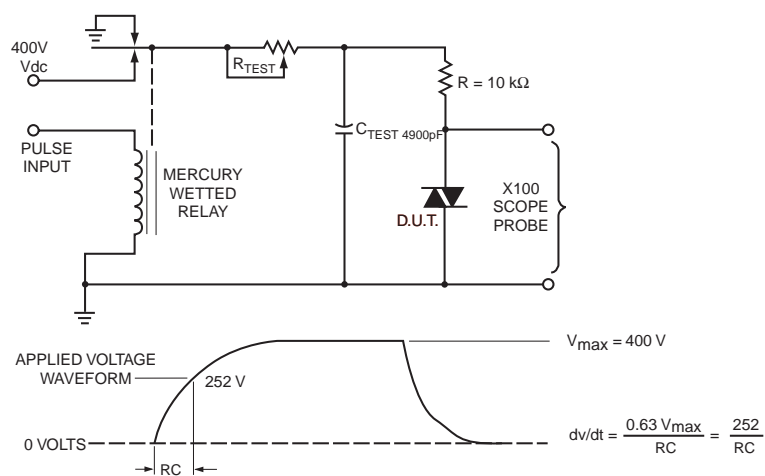



PERFORMANCE DATA

Fig.1 On-State Characteristics

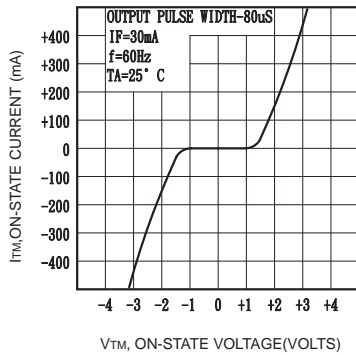

Fig.2 Leakage with LED Off versus Temperature

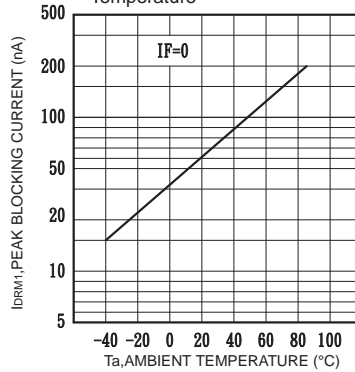
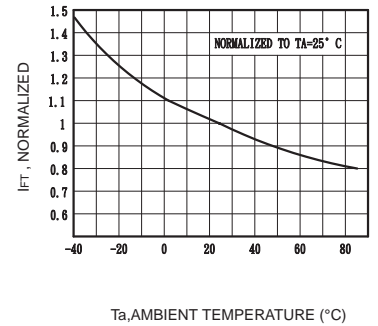

Fig.3 Trigger Current versus Temperature





Random-Phase
Triac Driver

MECHANICAL DIMENSIONS

4 PIN SMALL OUTLINE PACKAGE

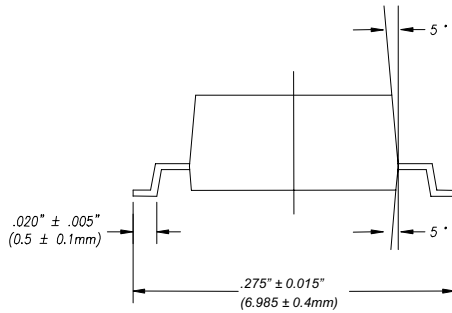

END VIEW

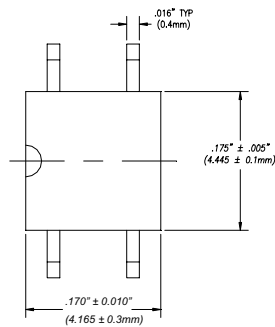

TOP VIEW

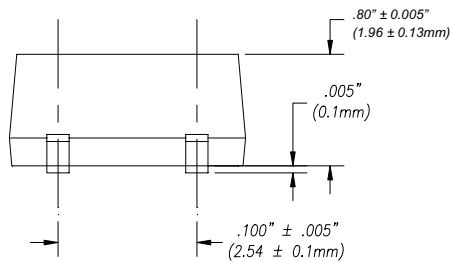

BACK VIEW