

## Final Data Sheet

### 1 Features

- Single wire transceiver for up to 33 kBit/s bus speed
- Compatibel to GM LAN Standard GMW 3089 - V1.26
- Excellent EMC performance
- High speed mode for up to 100 kBit/s bus speed
- Ambient operation range – 40 °C to 125 °C
- Supply voltage operation range 5.5 V to 28 V
- Typ. 30 µA total current consumption in sleep mode
- 4 kV ESD protection
- Short circuit and overtemperature protected
- Input bilevel feature for wake-up detection
- Output bilevel feature for wake up call
- Loss of Ground protection
- Bus dominant timeout feature
- Programmable slewrate

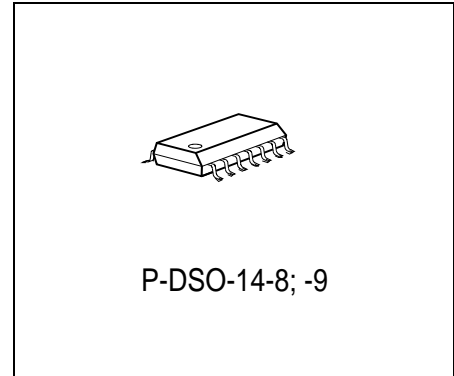

Type	Ordering Code	Package
TLE 6255 G	Q67006-A9352	P-DSO-14-9 (SMD)

### 2 Description

The TLE 6255 G is a special featured low speed transceiver for use in single wire applications.

The device is primarily designed for use in single wire CAN systems operating with various CSMA/CR (carrier sense multiple access/collision resolution) protocols such as the BOSCH Controller Area Network (CAN).

The normal communication bitrate in CAN-systems is up to 33 kBit/s. For software or diagnostic data download a high speed mode is offered that allows transmission rates up to 100 kBit/s.

With many integrated features such as slewrate controlled output, loss of ground circuit, bi-level wake-up and sleep mode for low power consumption the TLE 6255 G is optimized for use in automotive applications.

The device is based on Smart Power Technology SPT® which allows bipolar and CMOS control circuitry to be integrated with DMOS power devices on the same monolithic circuitry.

Additional features like short circuit and overtemperature protection, over- and undervoltage lockout are integrated. To enhance the reliability and robustness of the TLE 6255 G the enhanced power SO-14 package is used in order to provide high thermal capacity and low thermal resistance.

### 3 Pin Configuration (top view)

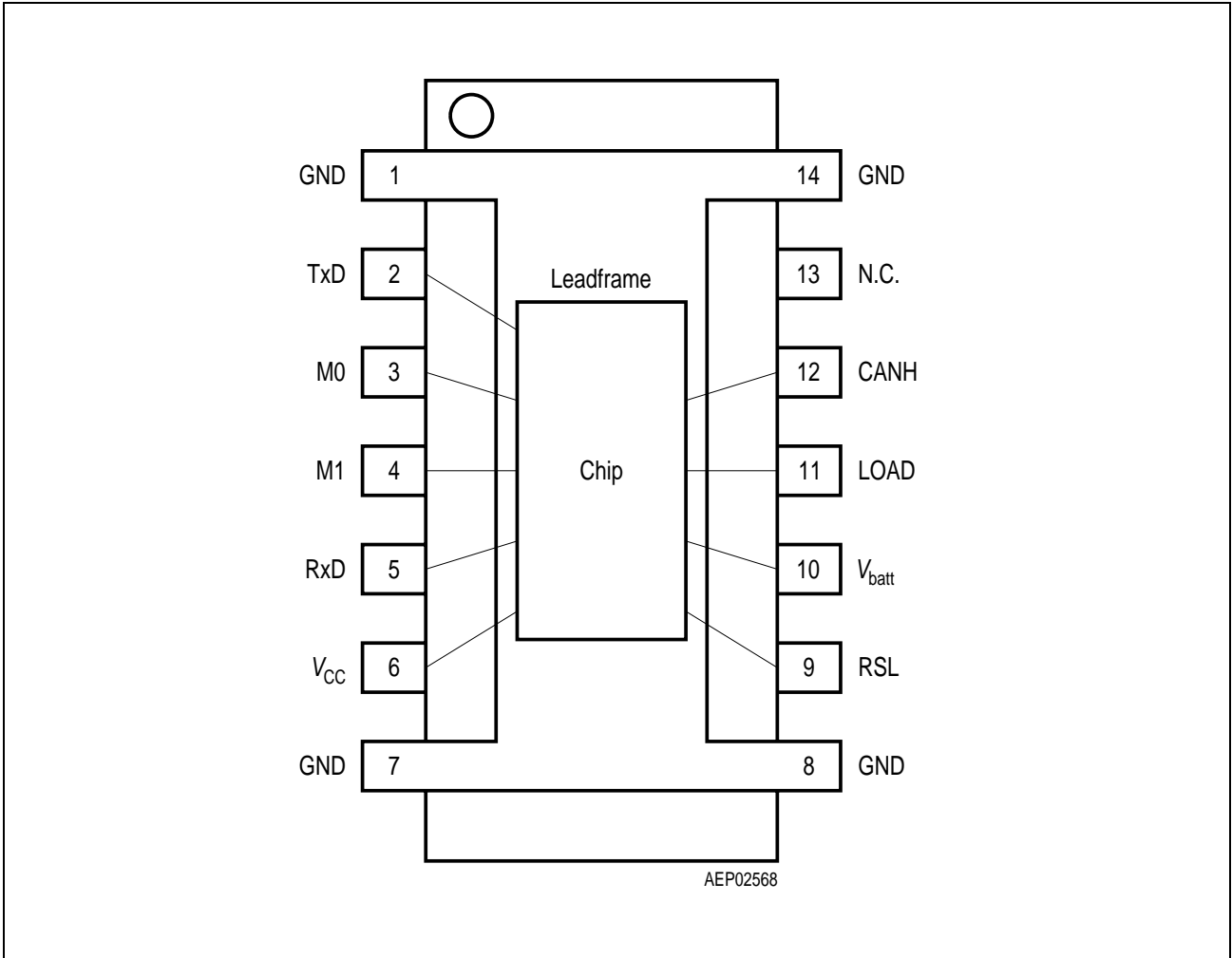

**Figure 1 Pin Configuration**

RxD = H indicates a bus recessive state, RxD = L a bus normal or high voltage dominant state.

#### 4 Pin Definitions and Functions

Pin No.	Symbol	Function
1, 7, 8, 14	GND	<b>Ground</b> ; internally connected to leadframe
2	TxD	<b>Transceiver-Input</b> ; low active, logic command to transmit on the single wire CAN bus; inverting: TxD = low causes CANH = dominant (high level); internal 10 k $\Omega$ pull up
3	M0	<b>Mode-Input 0</b> ; to program the device operating mode; internal pull down
4	M1	<b>Mode-Input 1</b> ; to program the device operating mode; internal pull down
5	RxD	<b>Receive-Output</b> ; open drain, logic data as sensed on the single wire CAN bus; inverting (RxD = L when CANH is dominant)
6	$V_{CC}$	<b>Supply Voltage</b> ; input for 5 V logic supply voltage
9	RSL	<b>Slewrate-Program-Input</b> ; an external resistor to $V_{CC}$ on this pin is required to program the bus output slewrate
10	$V_{batt}$	<b>Battery Supply Voltage</b> ; external blocking capacitor necessary (see application circuit)
11	LOAD	<b>Unit-Load Resistor Input</b> ; internal termination to GND
12	CANH	<b>CAN Bus Input/Output</b> ; single wire bus input and output; short circuit protected
13	N.C.	<b>not connected</b>

5 Block Diagram

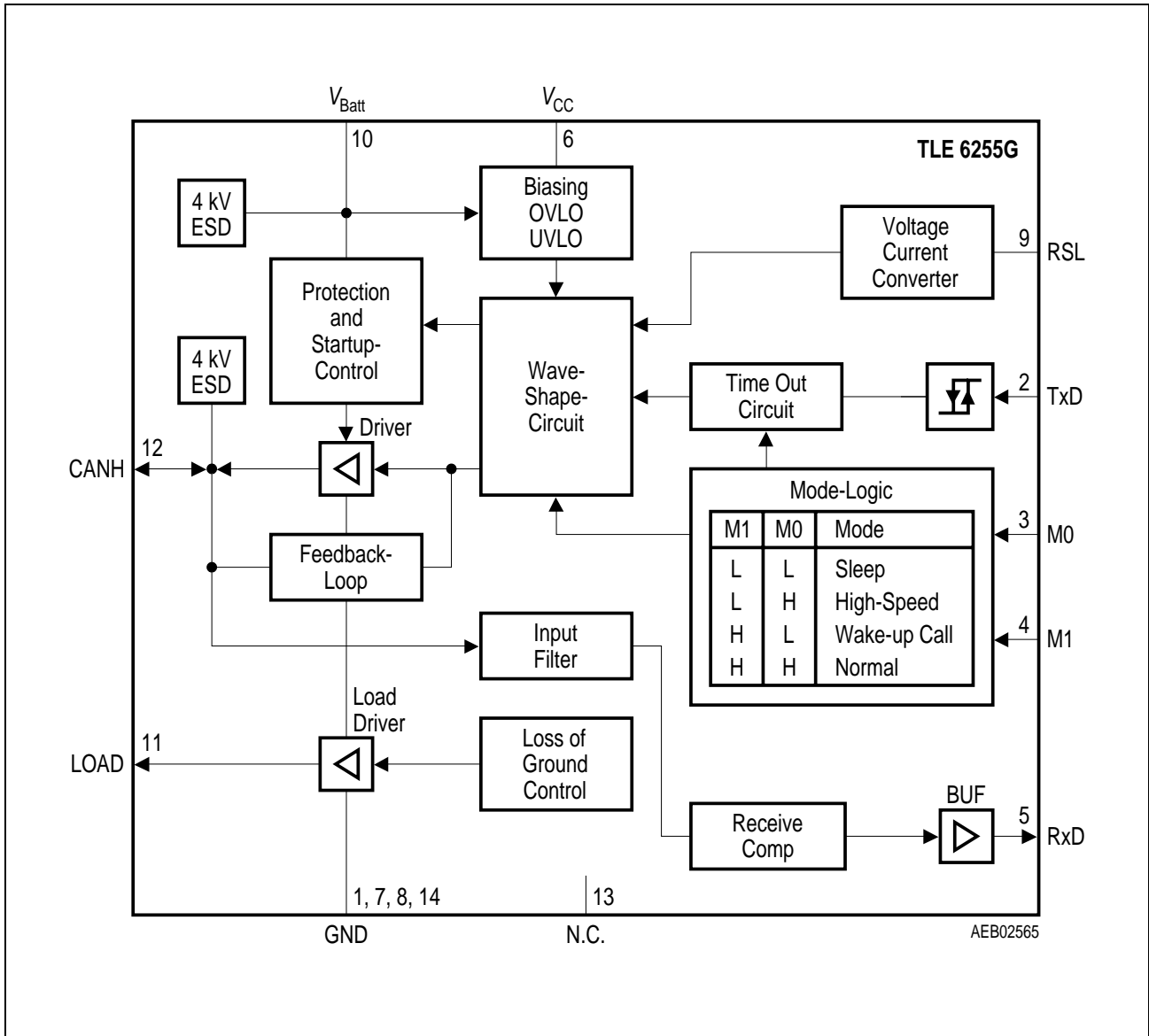

Figure 2 Block Diagram

## 6 Functional Description and Application Hints

### 6.1 Mode Control

By use of the two mode control pins M0 and M1 the transceiver can be set in the following modes.

**Table 1 Transceiver Modes**

#	M0	M1	Mode
1	Low	Low	Sleep mode
2	High	Low	High speed mode
3	Low	High	Wake-up call
4	High	High	Normal mode

#### Sleep-Mode

In the sleep mode the total current consumption of the TLE 6255 G is reduced to typically 30  $\mu$ A. Nodes not set to sleep mode can communicate without disturbing ECUs that are already set to sleep mode. To achieve a wake-up via the CAN bus a high voltage level message (wake-up call) is necessary. Only high voltage level messages are reported to the RxD pin in sleep mode. A wake-up from sleep mode of the transceiver itself has to be done by setting the control inputs M0 and M1. If there is no modification on the mode inputs the device remains in sleep mode after the wake-up signal is removed from the bus.

The transceiver's loss of ground protection circuit connection to ground is not interrupted when in the sleep mode.

#### High-Speed-Mode

The high-speed mode can be used for software or diagnostic data download with bitrates up to 100 kBit/s. Therefore the slewrate control feature is deactivated to achieve the required timings. Further an additional external resistor of 100  $\Omega$  from CANH to GND is necessary in this mode.

#### Wake-up-Call Mode

In this mode the TLE 6255 G sends the message to be transmitted as a high voltage wake-up message.

The bus includes a special node wake up capability which allows normal communication to take place among some nodes while leaving the other nodes in an undisturbed sleep state. This is accomplished by controlling the level of the signal voltages such that all nodes must wake up when they receive a higher voltage message signal waveform.

Communication at the lower, normal voltage levels shall not disturb the sleeping nodes ( $V_{\text{batt}} > 9 \text{ V}$ ).

## Normal Mode

In the normal mode the TLE 6255 G sends a normal voltage message waveform on the bus. It is possible to run the transceiver up to transmission rates of 33 kBits/s in this mode.

The waveform as well as the slew rate of the rising edge (recessive to dominant transition) are controlled by the internal active wave shaping circuit to minimize EME (electromagnetic emission). For the same reason waveform trailing edge control is required to assure that high frequency content is minimized at the beginning of the downward voltage slope (dominant to recessive transition). The remaining fall time occurs after the bus is inactive with drivers off and is determined by the RC time constant of the total bus load.

### 6.2 Slew-Rate Control

The CANH output voltage and current is controlled by an internal waveshaping circuit. For optimized adjusting of the slew rate to the system timing, the slew rate is programmable by an external resistor connected from pin RSL to  $V_{CC}$ . **Figure 4** shows the correlation of the slew rate to the resistor  $R_{RSL}$ .

### 6.3 Transmitter

The TLE 6255 G contains a high current fully short circuit and overtemperature protected highside-driver (pin CANH). To minimize spectral content the CANH-output waveform is controlled.

Logic low (TxD = L) on pin TxD will command the output stage to switch to dominant high potential; TxD = H to recessive low on the bus.

To avoid the bus to be blocked by a permanent dominant TxD input signal, the TLE 6255 G incorporates a timeout feature. In case of TxD = L for longer than the internal fixed timeout the CANH output is switched off automatically. The timeout is resetted by a H-signal at TxD without a delay.

The loss of an ECU ground may cause the ECU to source current through the various ECU circuits to the communications bus instead of to the vehicle system ground. Therefore the unit-load resistor of any ECU is connected to the LOAD-pin. The TLE 6255 G incorporates a reverse protected switch from LOAD to ground potential. This switch is automatically switched off in a loss of ground state.

### 6.4 Receiver

In normal, high speed and wakeup-mode all data on the bus is sensed by the receive comparator and transmitted to the RxD output. In sleep mode no normal level data is detected. The receiver threshold is set to the wake-up level. So a wake-up interrupt is sent only in case of a wake-up call on the bus. An internal fixed filter improves the EMC susceptibility.

## 6.5 Unit Load Resistor

The TLE 6255 covers the specification GMW 3089 V1.26 or the so called first generation of SW CAN. GM decided to design a second generation of SW CAN, which is defined in the specification GMW 3089 V2.0. This led to some differences in the electrical characteristics (GND shift, time constants, etc.) and also in the pinout (pin 9 is used to control a voltage regulator).

It must be pointed out, that GMW 3089 V1.26 defines a unit load resistance of:

$$R_{UL} = 8,999 \text{ to } 9,126 \text{ kOhm}$$

With this  $R_{UL}$ , the TLE 6255 complies to the GMW 3089 V1.26 specification. Values out of this range are not a subject to GMW 3089 V1.26!

The loss of ground circuit is not specified to function when the load resistor is out of the 8.999-9.126 kohm range!

## 7 Absolute Maximum Ratings

Parameter	Symbol	Limit Values		Unit	Remarks
		min.	max.		

### Voltages

Supply voltage	$V_{batt}$	- 0.3	40	V	-
CAN bus input/output voltage	$V_{CANH}$	- 28	28	V	-
Load voltage	$V_{LOAD}$	- 28	28	V	-
Logic supply voltage	$V_{CC}$	- 0.3	7	V	-
Logic voltages ( $V_{RxD}$ ; $V_{TxD}$ ; $V_{M0}$ ; $V_{M1}$ ; $V_{RSL}$ )	$V_{logic}$	- 0.3	7	V	-

### Currents

CAN Bus current	$I_{CANH}$	-	-	mA	internally limited
Load current	$I_{LOAD}$	-	-	mA	internally limited

### ESD-Protection (Human Body Model; According to MIL STD 833 D)

Pin CANH, $V_{batt}$	$V_{ESD}$	- 4000	4000	V	-
Other pins	$V_{ESD}$	- 2000	2000	V	-

### Temperatures

Junction temperature	$T_j$	- 40	150	°C	-
Junction temperature	$T_j$	-	175	°C	$t < 1000$ h
Junction temperature	$T_j$	-	200	°C	$t < 10$ h
Storage temperature	$T_{stg}$	- 50	150	°C	-

### Thermal Resistances

Junction to pin	$R_{thj-pin}$	-	40	K/W	junction to pin 1
Junction ambient	$R_{thj-a}$	-	65	K/W	-

*Note: Maximum ratings are absolute ratings; exceeding any one of these values may cause irreversible damage to the integrated circuit.*



## 8 Operating Range

Parameter	Symbol	Limit Values		Unit	Remarks
		min.	max.		
Supply voltage	$V_{\text{batt}}$	$V_{\text{UV OFF}}$	28	V	After $V_{\text{batt}}$ rising above $V_{\text{UV ON}}$
Supply voltage increasing	$V_{\text{batt}}$	- 0.3	$V_{\text{UV ON}}$	V	Outputs in tristate
Supply voltage decreasing	$V_{\text{batt}}$	- 0.3	$V_{\text{UV OFF}}$	V	Outputs in tristate
Logic supply voltage	$V_{\text{CC}}$	$V_{\text{POR OF}}$	5.5	V	After $V_{\text{CC}}$ rising above $V_{\text{POR ON}}$
Logic supply voltage; increasing	$V_{\text{CC}}$	- 0.3	$V_{\text{POR ON}}$	V	Outputs in tristate
Logic supply voltage; decreasing	$V_{\text{CC}}$	- 0.3	$V_{\text{POR OF}}$	V	Outputs in tristate
Junction temperature	$T_{\text{j}}$	- 40	150	°C	-
RSL resistance	$R_{\text{RSL}}$	35	200	kΩ	-

### Thermal Shutdown

Thermal shutdown junction temperature	$T_{\text{jSD}}$	150	200	°C	-
Thermal switch-on junction temperature	$T_{\text{jSO}}$	120	170	°C	temperature hysteresis $\Delta T = 30^\circ \text{K}$ (typ.)

## 9 Electrical Characteristics

5.5 V <  $V_{batt}$  < 16 V; 4.75 V <  $V_{CC}$  < 5.25 V;  $-40\text{ }^{\circ}\text{C} < T_j < 150\text{ }^{\circ}\text{C}$ ; M0 = M1 = H;  $R_{UL} = 9.1\text{ k}\Omega$  (connected between CANH and LOAD);  $R_{RSL} = 39\text{ k}\Omega$ ; all voltages with respect to ground; positive current defined flowing into pin; unless otherwise specified

Parameter	Symbol	Limit Values			Unit	Test Condition
		min.	typ.	max.		

### Current Consumption

Supply current at $V_{batt}$ ; sleep mode	$I_{batt}$	–	20	40	$\mu\text{A}$	M0 = M1 = L;
Supply current at $V_{CC}$ ; sleep mode	$I_{CC}$	–	10	30	$\mu\text{A}$	M0 = M1 = L;
Supply current at $V_{batt}$	$I_{batt}$	–	3	6	mA	TxD = L
Supply current at $V_{batt}$	$I_{batt}$	–	1.5	3	mA	TxD = H
Supply current at $V_{batt}$	$I_{batt}$	–	5	9	mA	TxD = L; M0 = L
Supply current at $V_{batt}$	$I_{batt}$	–	4	6	mA	TxD = H; M0 = L
Supply current at $V_{CC}$	$I_{CC}$	–	3	5	mA	TxD = H or L; M0 = H or L

### Over- and Under Voltage Lockout

UV Switch ON voltage	$V_{UVON}$	–	5.2	5.6	V	$V_{batt}$ increasing; $V_{CC} = 5\text{ V}$
UV Switch OFF voltage	$V_{UVOFF}$	4.00	4.6	5.1	V	$V_{batt}$ decreasing; $V_{CC} = 5\text{ V}$
UV ON/OFF Hysteresis	$V_{UVHY}$	–	0.6	–	V	$V_{UVON} - V_{UVOFF}$
OV Switch OFF voltage	$V_{OVOFF}$	30	33	38	V	$V_{batt}$ increasing
OV Switch ON voltage	$V_{OVON}$	28	32	36	V	$V_{batt}$ decreasing
OV ON/OFF Hysteresis	$V_{OVHY}$	0.2	2	–	V	$V_{OVOFF} - V_{OVON}$

5.5 V <  $V_{\text{batt}}$  < 16 V; 4.75 V <  $V_{\text{CC}}$  < 5.25 V;  $-40\text{ }^{\circ}\text{C} < T_{\text{j}} < 150\text{ }^{\circ}\text{C}$ ; M0 = M1 = H;  $R_{\text{UL}} = 9.1\text{ k}\Omega$  (connected between CANH and LOAD);  $R_{\text{RSL}} = 39\text{ k}\Omega$ ; all voltages with respect to ground; positive current defined flowing into pin; unless otherwise specified

Parameter	Symbol	Limit Values			Unit	Test Condition
		min.	typ.	max.		

### Power ON/OFF Reset at $V_{\text{CC}}$

Power ON Reset voltage	$V_{\text{PORON}}$	4.00	4.25	4.50	V	$V_{\text{CC}}$ increasing
Power OFF Reset voltage	$V_{\text{POROF}}$	3.50	3.75	4.00	V	$V_{\text{CC}}$ decreasing
POR ON/OFF Hysteresis	$V_{\text{PORHY}}$	0.1	0.5	–	V	$V_{\text{PORON}} - V_{\text{POROF}}$

### Transceive Input TxD

H-input voltage threshold	$V_{\text{TxDH}}$	–	2.6	$0.7 \times V_{\text{CC}}$	V	–
L-input voltage threshold	$V_{\text{TxDL}}$	$0.3 \times V_{\text{CC}}$	2.4	–	V	–
Hysteresis of input voltage	$V_{\text{TxDHY}}$	50	200	500	mV	–
Pull up current	$I_{\text{TXD}}$	– 20	– 10	– 5	$\mu\text{A}$	$0\text{ V} < V_{\text{TXD}} < 4\text{ V}$
Timeout reaction time	$t_{\text{TOR}}$	5	10	30	ms	–

### Receive Output RxD

Output leakage current	$I_{\text{RxDLK}}$	– 2	0	10	$\mu\text{A}$	$V_{\text{RxD}} = 5\text{ V}$
Output low voltage level	$V_{\text{RxDL}}$	–	0.2	0.4	V	$I_{\text{RxDL}} = 2\text{ mA}$
Falltime	$t_{\text{FRxD}}$	–	80	200	ns	$C_{\text{RxD}} = 25\text{ pF}$ to GND

5.5 V <  $V_{\text{batt}}$  < 16 V; 4.75 V <  $V_{\text{CC}}$  < 5.25 V;  $-40\text{ }^{\circ}\text{C} < T_j < 150\text{ }^{\circ}\text{C}$ ; M0 = M1 = H;  $R_{\text{UL}} = 9.1\text{ k}\Omega$  (connected between CANH and LOAD);  $R_{\text{RSL}} = 39\text{ k}\Omega$ ; all voltages with respect to ground; positive current defined flowing into pin; unless otherwise specified

Parameter	Symbol	Limit Values			Unit	Test Condition
		min.	typ.	max.		

### Mode Input M0 and M1

H-input voltage threshold	$V_{\text{M0,1H}}$	–	2.6	$0.7 \times V_{\text{CC}}$	V	–
L-input voltage threshold	$V_{\text{M0,1L}}$	$0.3 \times V_{\text{CC}}$	2.4	–	V	–
Hysteresis of input voltage	$V_{\text{M0,1HY}}$	50	200	500	mV	–
Pull down current	$I_{\text{M0,1}}$	5	20	50	$\mu\text{A}$	$1\text{ V} < V_{\text{M0,1}} < 5\text{ V}$

### Mode Change Delaytimes

Normal to high-speed	$t_{\text{DNH}}$	–	5	30	$\mu\text{s}$	M1 H to L; (not tested, specified by design)
Normal to wakeup call	$t_{\text{DNW}}$	–	5	30	$\mu\text{s}$	M0 H to L (not tested, specified by design)
Normal to sleep	$t_{\text{DNS}}$	–	5	500	$\mu\text{s}$	M0 and M1 H to L (not tested, specified by design)
Sleep to normal	$t_{\text{DSN}}$	–	5	50	$\mu\text{s}$	M0 and M1 L to H (not tested, specified by design)

### Slewrate Input RSL

Output voltage	$V_{\text{RSL}}$	2.5	3	3.5	V	$I_{\text{RSL}} = 100\text{ }\mu\text{A}$
----------------	------------------	-----	---	-----	---	---

5.5 V <  $V_{\text{batt}}$  < 16 V; 4.75 V <  $V_{\text{CC}}$  < 5.25 V;  $-40\text{ }^{\circ}\text{C} < T_j < 150\text{ }^{\circ}\text{C}$ ; M0 = M1 = H;  
 $R_{\text{UL}} = 9.1\text{ k}\Omega$  (connected between CANH and LOAD);  $R_{\text{RSL}} = 39\text{ k}\Omega$ ; all voltages with respect to ground; positive current defined flowing into pin; unless otherwise specified

Parameter	Symbol	Limit Values			Unit	Test Condition
		min.	typ.	max.		

### CANH as Bus Input / Receiver

Wake up offset threshold	$V_{\text{IHWUO}}$	$V_{\text{batt}} - 4.30$	–	$V_{\text{batt}} - 3.25$	V	$V_{\text{batt}} = 8\text{ V}$ see note; see <b>Figure 8</b>
Wake up fixed threshold	$V_{\text{IHWUF}}$	6.15	7.1	8.10	V	$V_{\text{batt}} = 14\text{ V}$ see note; see <b>Figure 8</b>
Wakeup dead time	$t_{\text{DWU}}$	10	21	50	$\mu\text{s}$	–
Wakeup minimal pulse time	$t_{\text{WUMIN}}$	1	5	10	$\mu\text{s}$	–
Receive threshold; in normal, high-speed and wake-up mode	$V_{\text{IH}}$	1.8	2	2.2	V	$6\text{ V} < V_{\text{batt}} < 16\text{ V}$
Receive hysteresis	$V_{\text{RHY}}$	50	80	200	mV	–
Receive propagation time	$t_{\text{CRF}}$	0.05	0.3	1	$\mu\text{s}$	$V_{\text{CANH}} > (V_{\text{IH}} + 0.8\text{ V})$ to RxD = L; $6\text{ V} < V_{\text{batt}} < 16\text{ V}$
Receive propagation time; high speed	$t_{\text{CRF}}$	0.05	0.25	0.5	$\mu\text{s}$	$V_{\text{CANH}} > (V_{\text{IH}} + 0.8\text{ V})$ to RxD = L; M1 = L; $6\text{ V} < V_{\text{batt}} < 16\text{ V}$ ; $T_j < 125\text{ }^{\circ}\text{C}$
Receive propagation time	$t_{\text{CRR}}$	0.05	0.3	1	$\mu\text{s}$	$V_{\text{CANH}} < (V_{\text{IH}} - 0.8\text{ V})$ to RxD = H; $R_{\text{RxD}} = 2.4\text{ k}\Omega$ $6\text{ V} < V_{\text{batt}} < 16\text{ V}$
Receive propagation time; high speed	$t_{\text{CRR}}$	0.05	0.25	0.5	$\mu\text{s}$	$V_{\text{CANH}} < (V_{\text{IH}} - 0.8\text{ V})$ to RxD = H; $R_{\text{RxD}} = 2.4\text{ k}\Omega$ M1 = L; $6\text{ V} < V_{\text{batt}} < 16\text{ V}$ ; $T_j < 125\text{ }^{\circ}\text{C}$
Receive blanking time after CANH H to L transition	$t_{\text{CRB}}$	1.5	3.0	5.0	$\mu\text{s}$	see <b>Figure 7</b>

*Note: The device will send a wake up call to the microcontroller at the minimum of  $V_{\text{IHWUO}}$  or  $V_{\text{IHWUF}}$ .*

5.5 V <  $V_{batt}$  < 16 V; 4.75 V <  $V_{CC}$  < 5.25 V;  $-40\text{ }^{\circ}\text{C} < T_j < 150\text{ }^{\circ}\text{C}$ ; M0 = M1 = H;  
 $R_{UL} = 9.1\text{ k}\Omega$  (connected between CANH and LOAD);  $R_{RSL} = 39\text{ k}\Omega$ ; all voltages with respect to ground; positive current defined flowing into pin; unless otherwise specified

Parameter	Symbol	Limit Values			Unit	Test Condition
		min.	typ.	max.		

### CANH as Bus Output / Transmitter

Offset wakeup output high voltage	$V_{OHWUO}$	$V_{batt} - 1.5$	–	$V_{batt}$	V	$220\ \Omega < R_{UL} < 9.1\text{ k}\Omega$ ; TxD = L; M0 = L; $6\text{ V} < V_{batt} < V_{OHWUF}$
Fixed wakeup output high voltage	$V_{OHWUF}$	9.7	–	12	V	$220\ \Omega < R_{UL} < 9.1\text{ k}\Omega$ TxD = L; M0 = L $V_{OHWUF} < V_{batt} < 16\text{ V}$
Bus output high voltage; normal and high speed	$V_{OH}$	3.60	4.0	4.55	V	$100\ \Omega < R_{UL} < 9.1\text{ k}\Omega$ TxD = L; $6\text{ V} < V_{batt} < 16\text{ V}$
Bus output current limit	$I_{OLI}$	200	250	350	mA	TxD = L; $V_{CANH} = 0\text{ V}$
Bus output leakage current	$I_{OLK}$	– 10	–	200	$\mu\text{A}$	TxD = H; $T_j < 125\text{ }^{\circ}\text{C}$ ; $V_{batt} - 28\text{ V} < V_{CANH} < V_{batt} - 1\text{ V}$
Bus output leakage current (loss of ground)	$I_{OLK}$	– 50	–	200	$\mu\text{A}$	$0\text{ V} < V_{batt} < V_{UVOFF}$ ; $V_{batt} - 28\text{ V} < V_{CANH} < V_{batt} - 1\text{ V}$
Slew rate rising edge, normal mode	$S_{CANH}$	–	2.0	–	V/ $\mu\text{s}$	$20\% < V_{CANH} < 80\%$
Slew rate rising edge, wake-up mode	$S_{CANH}$	–	4.0	–	V/ $\mu\text{s}$	$20\% < V_{CANH} < 80\%$ M0 = L; $V_{batt} = 12\text{ V}$
Slew rate rising edge; high speed;	$S_{CANH}$	5	16	25	V/ $\mu\text{s}$	$20\% < V_{CANH} < 80\%$ M1 = L; $T_j < 125\text{ }^{\circ}\text{C}$
Transmit propagation time; normal mode	$t_{TCF}$	2	5	6	$\mu\text{s}$	TxD = (H to L) to $V_{CANH} = (V_{IH} + 0.8\text{ V})$ $1.0\ \mu\text{s} < \tau < 3.6\ \mu\text{s}$ ;
Transmit propagation time; wake-up mode	$t_{TCF}$	1	5	4	$\mu\text{s}$	TxD = (H to L) to $V_{CANH} = (V_{IH} + 0.8\text{ V})$ ; M0 = L; $V_{batt} = 12\text{ V}$ ; $1.0\ \mu\text{s} < \tau < 3.6\ \mu\text{s}$

5.5 V <  $V_{\text{batt}}$  < 16 V; 4.75 V <  $V_{\text{CC}}$  < 5.25 V;  $-40\text{ }^{\circ}\text{C} < T_j < 150\text{ }^{\circ}\text{C}$ ; M0 = M1 = H;  $R_{\text{UL}} = 9.1\text{ k}\Omega$  (connected between CANH and LOAD);  $R_{\text{RSL}} = 39\text{ k}\Omega$ ; all voltages with respect to ground; positive current defined flowing into pin; unless otherwise specified

Parameter	Symbol	Limit Values			Unit	Test Condition
		min.	typ.	max.		
Transmit propagation time; high speed mode	$t_{\text{TCF}}$	–	0.5	1.5	$\mu\text{s}$	TxD = (H to L) to $V_{\text{CANH}} = (V_{\text{IH}} + 0.8\text{ V})$ ; M1 = L; $\tau < 1\text{ }\mu\text{s}$ ; $T_j < 125\text{ }^{\circ}\text{C}$
Transmit propagation time; normal mode	$t_{\text{TCR}}$	3	5	8	$\mu\text{s}$	TxD = (L to H) to $V_{\text{CANH}} = (V_{\text{IH}} - 0.8\text{ V})$ $1.0\text{ }\mu\text{s} < \tau < 3.6\text{ }\mu\text{s}$ ;
Transmit propagation time; wake-up mode	$t_{\text{TCR}}$	3	–	12.7	$\mu\text{s}$	TxD = (L to H) to $V_{\text{CANH}} = (V_{\text{IH}} - 0.8\text{ V})$ ; M0 = L; $1.0\text{ }\mu\text{s} < \tau < 3.6\text{ }\mu\text{s}$ ;
Transmit propagation time; high speed	$t_{\text{TCRH}}$	–	–	3.0	$\mu\text{s}$	TxD = (L to H) to $V_{\text{CANH}} = (V_{\text{IH}} - 0.8\text{ V})$ ; M1 = L; $\tau < 1.6\text{ }\mu\text{s}$ ; $T_j < 125\text{ }^{\circ}\text{C}$

### Unit-Load Resistor Ground Input LOAD

Output low voltage level	$V_{\text{LOAD}}$	–	20	100	mV	$I_{\text{LOAD}} = 2\text{ mA}$ ; $8\text{ V} < V_{\text{batt}} < 16\text{ V}$
Output leakage current (loss of ground)	$I_{\text{LOADLK}}$	– 50	–	50	$\mu\text{A}$	$0\text{ V} < V_{\text{bat}} < V_{\text{UVOFF}}$ $T_j < 125\text{ }^{\circ}\text{C}$ ; $V_{\text{batt}} - 28\text{ V}$ $< V_{\text{CANH}} < V_{\text{batt}} - 1\text{ V}$

10 Diagrams

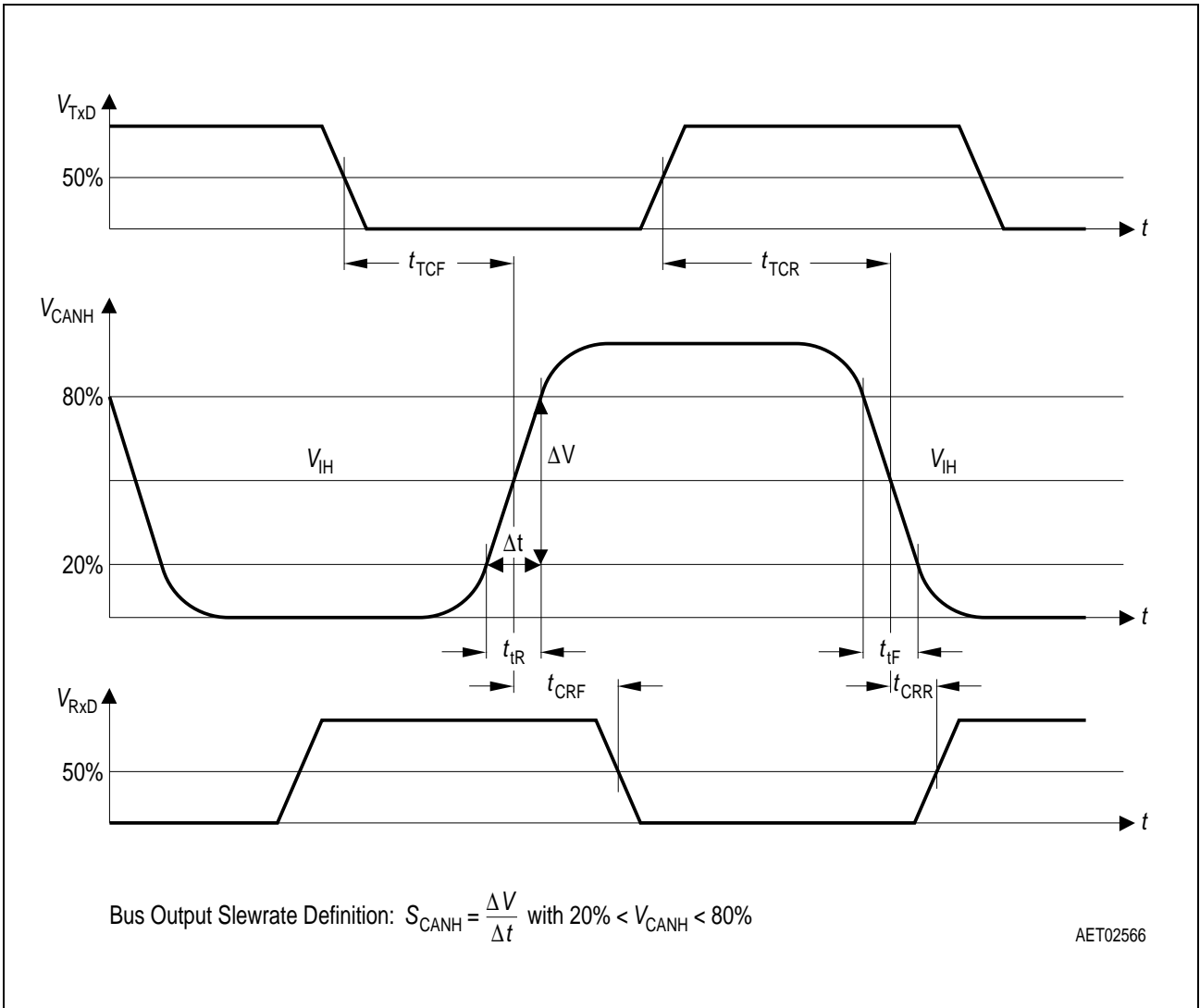

Figure 3 Input/Output-Timing (Pin CANH, TxD and RxD)



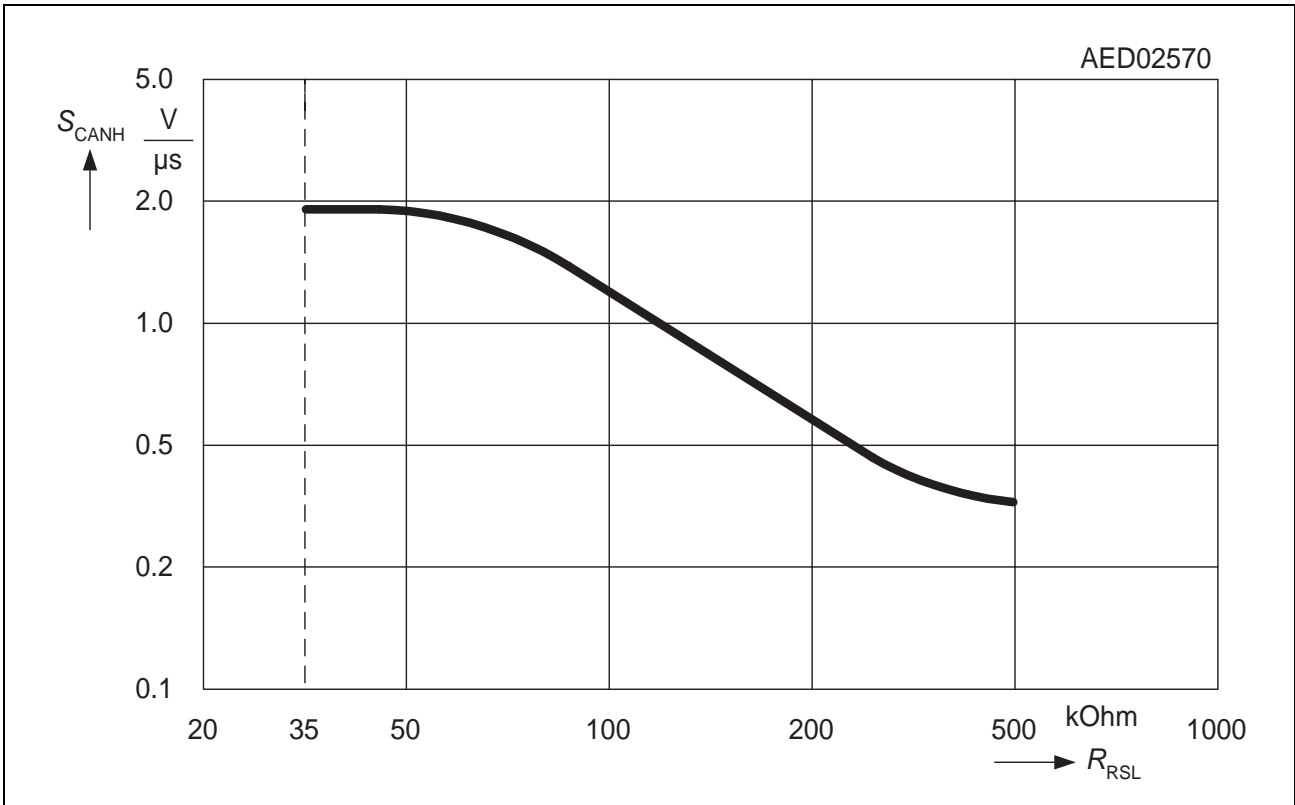

Figure 4 Slewwrate  $S_{CANH}$  vs. Programming Resistor  $R_{RSL}$  (Pin RSL)

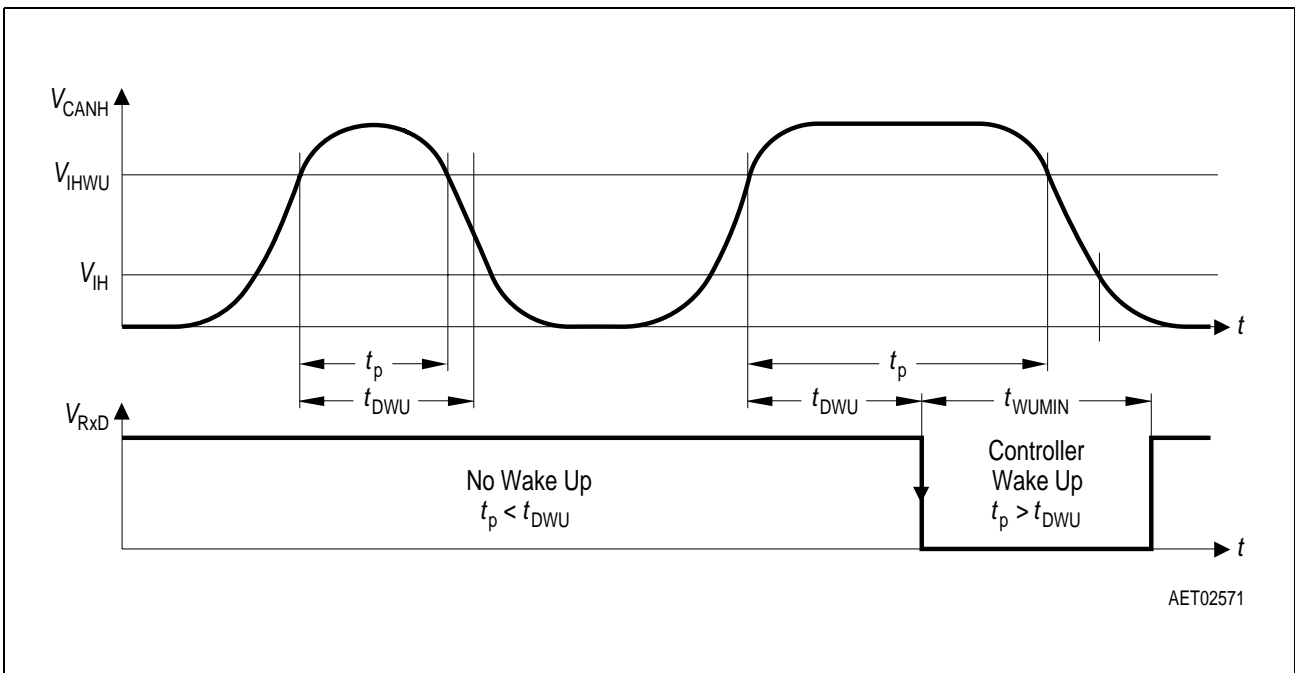
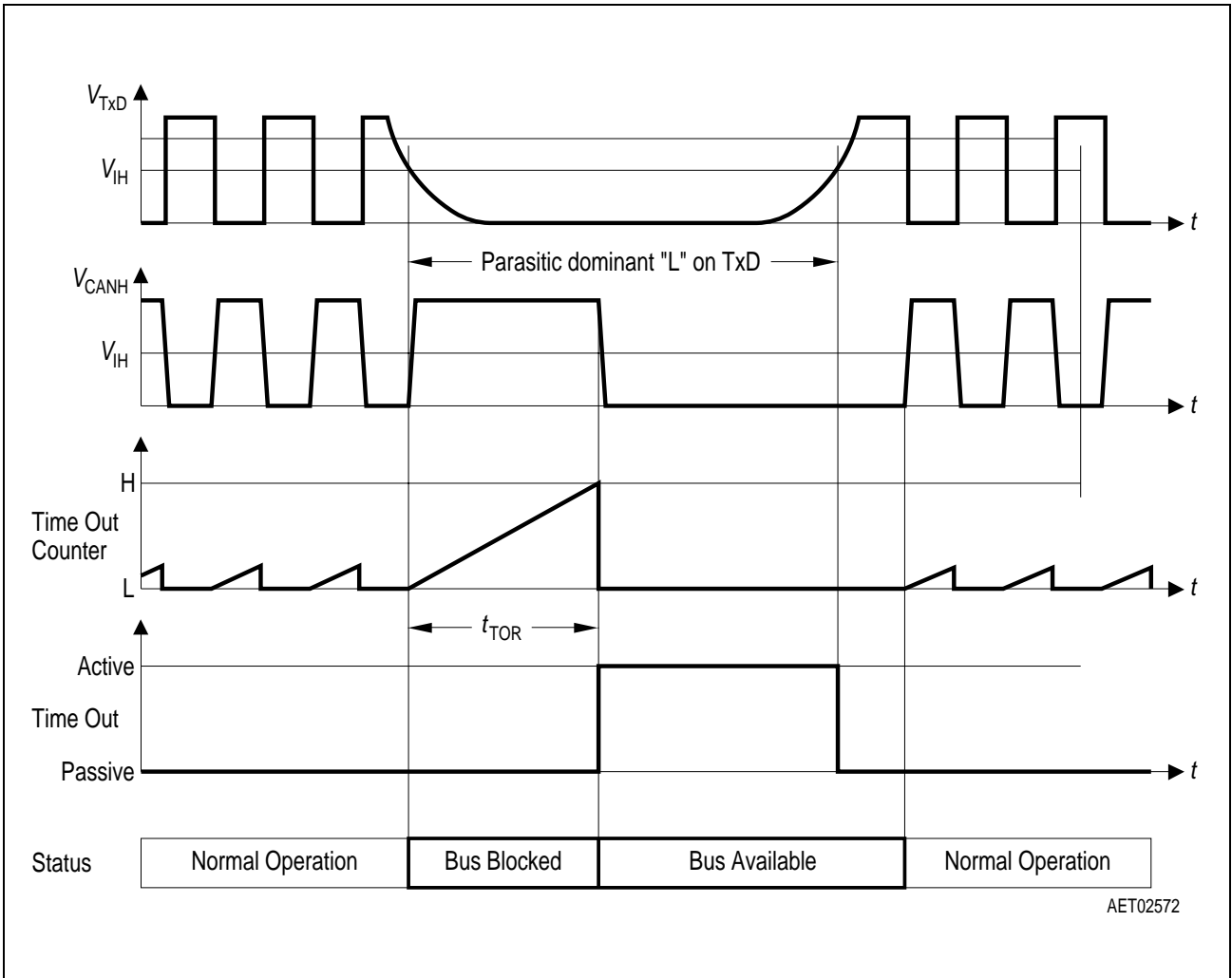

Figure 5 Wakeup Deadtime  $t_{DWU}$



**Figure 6 Bus Dominant Blanking Time  $t_{TOR}$**

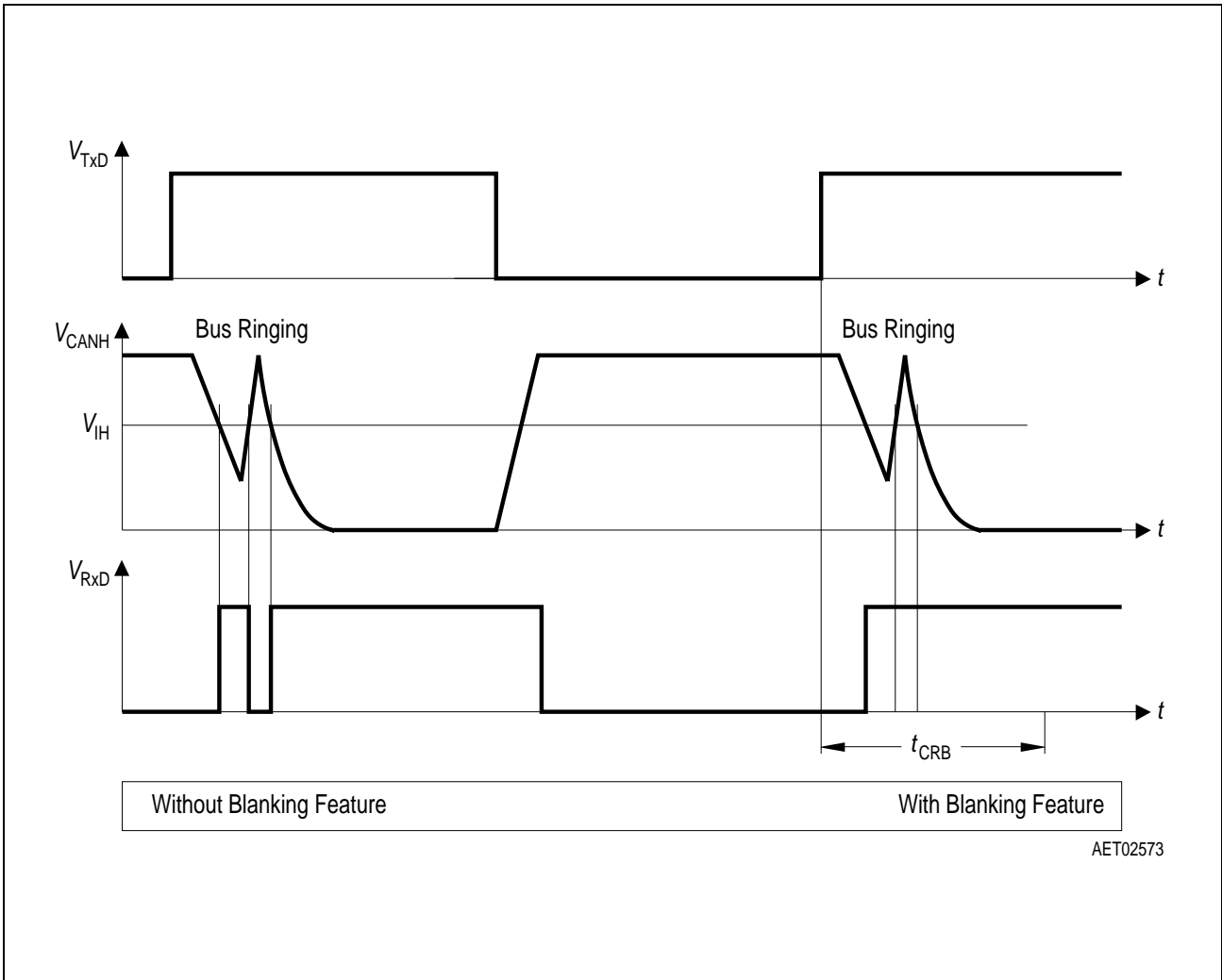

Figure 7 Rx D Blanking Time  $t_{CRB}$

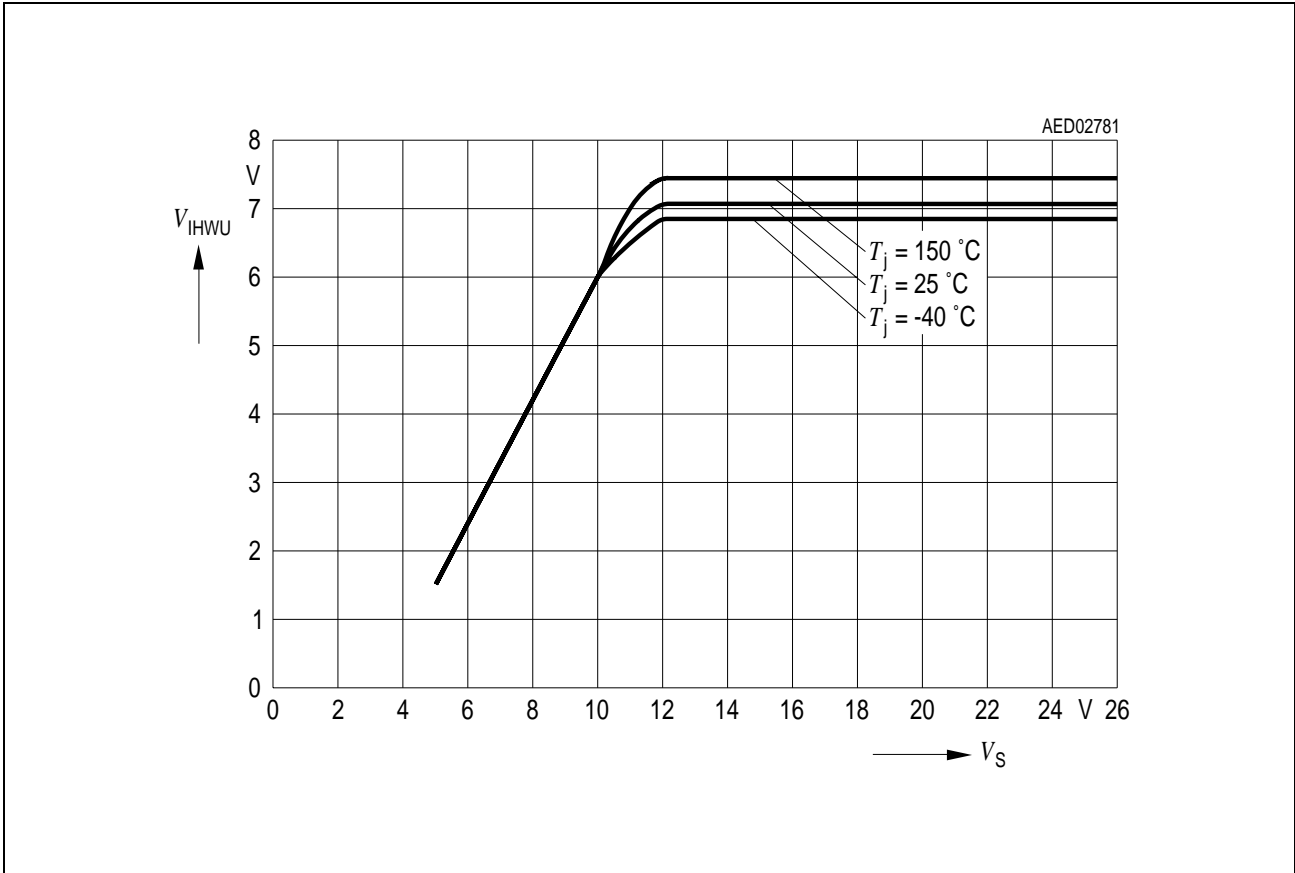
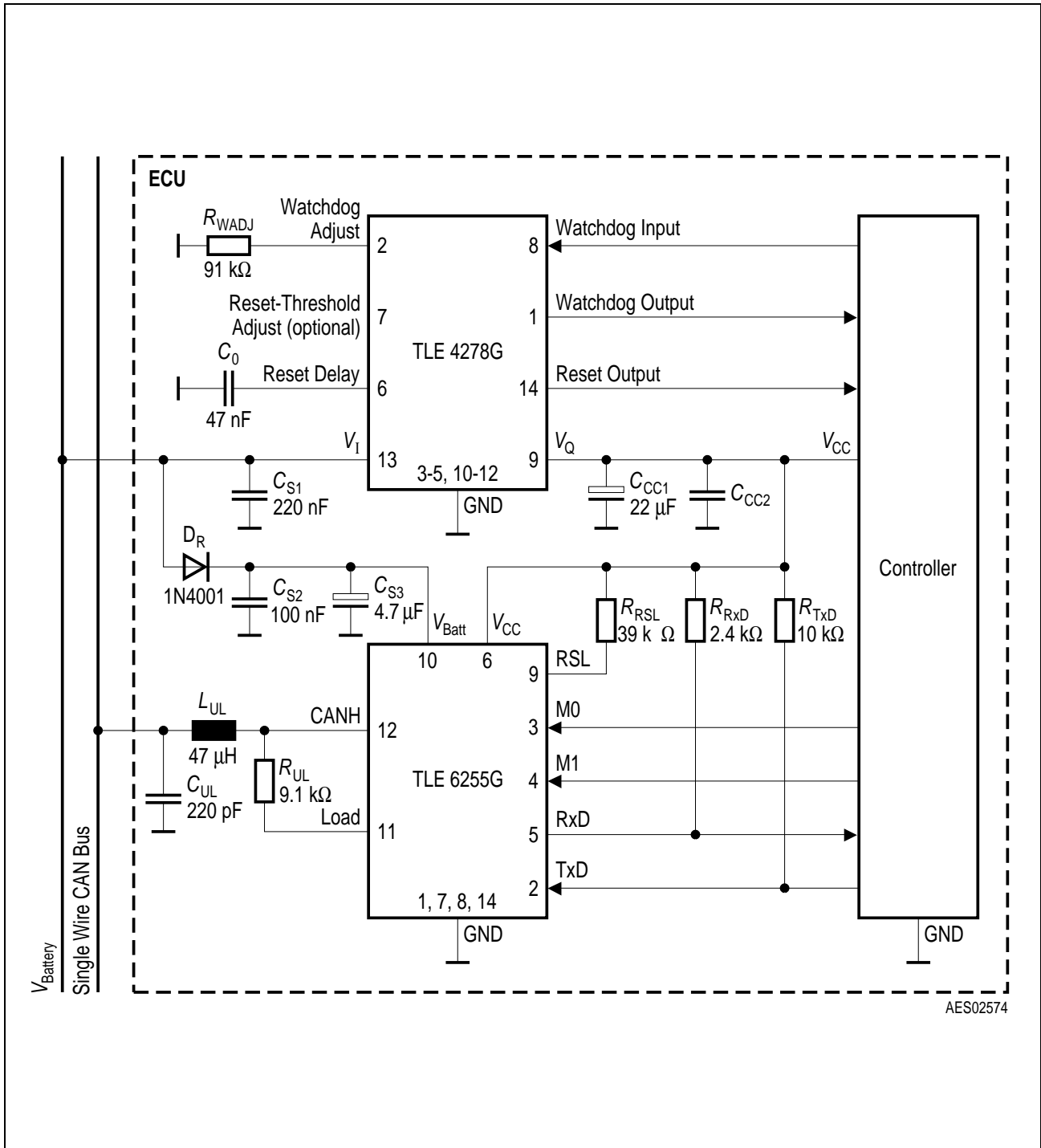

Figure 8 Wake-up Threshold  $V_{IHWU}$  vs. Supply Voltage  $V_S$

11 Application Circuit



AES02574

Figure 9 Application Circuit

12 Package Outlines

**P-DSO-14-9**  
(Plastic Dual Small Outline)

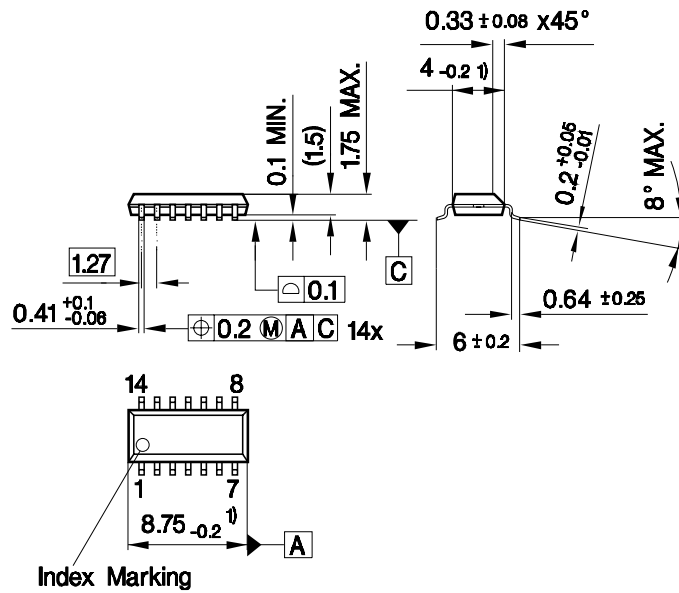

1) Does not include plastic or metal protrusion of 0.15 max. per side

GPS09222

**Sorts of Packing**

Package outlines for tubes, trays etc. are contained in our Data Book "Package Information".

SMD = Surface Mounted Device

Dimensions in mm

**Edition 2003-11-27**

**Published by Infineon  
Technologies AG,  
St.-Martin-Strasse 53,  
D-81541 München**

**© Infineon Technologies AG 2003.  
All Rights Reserved.**

**Attention please!**

The information herein is given to describe certain components and shall not be considered as warranted characteristics.

Terms of delivery and rights to technical change reserved.

We hereby disclaim any and all warranties, including but not limited to warranties of non-infringement, regarding circuits, descriptions and charts stated herein.

Infineon Technologies is an approved CECC manufacturer.

**Information**

For further information on technology, delivery terms and conditions and prices please contact your nearest Infineon Technologies Office in Germany or our Infineon Technologies Representatives worldwide (see address list).

**Warnings**

Due to technical requirements components may contain dangerous substances. For information on the types in question please contact your nearest Infineon Technologies Office.

Infineon Technologies Components may only be used in life-support devices or systems with the express written approval of Infineon Technologies, if a failure of such components can reasonably be expected to cause the failure of that life-support device or system, or to affect the safety or effectiveness of that device or system. Life support devices or systems are intended to be implanted in the human body, or to support and/or maintain and sustain and/or protect