

Bicolor SMD LED

Description

These devices have been designed to meet the increasing demand for surface mounting technology. The package of the TLMEK3100 is the PLCC-3 (equivalent to a size B tantalum capacitor).

It consists of a lead frame which is embedded in a white thermoplast. The reflector inside this package is filled up with clear epoxy.

This SMD device consists of a red and yellow chip. So it is possible to choose the color in one device.

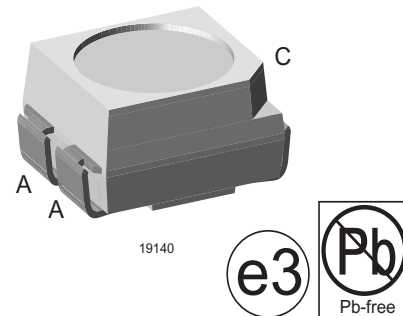

Features

- SMD LED with exceptional brightness
- Multicolored
- Luminous intensity categorized
- Compatible with automatic placement equipment
- EIA and ICE standard package
- Compatible with infrared, vapor phase and wave solder processes according to CECC
- Available in 8 mm tape
- Low profile package
- Non-diffused lens: excellent for coupling to light pipes and backlighting
- Low power consumption
- Luminous intensity ratio in one packaging unit
 $I_{Vmax}/I_{Vmin} \leq 2.0$
- Lead-free device

Applications

Automotive: Backlighting in dashboards and switches
 Telecommunication: Indicator and backlighting in telephone and fax
 Indicator and backlight for audio and video equipment
 Indicator and backlight in office equipment
 Flat backlight for LCDs, switches and symbols
 General use

Parts Table

Part	Color, Luminous Intensity	Angle of Half Intensity ($\pm\phi$)	Technology
TLMEK3100	Red/Yellow	60 °	AllnGaP on GaAs

Absolute Maximum Ratings

$T_{amb} = 25\text{ }^{\circ}\text{C}$, unless otherwise specified

Parameter	Test condition	Symbol	Value	Unit
Reverse voltage per diode	$I_R = 10\text{ }\mu\text{A}$	V_R	6	V
DC Forward current per diode	$T_{amb} \leq 85\text{ }^{\circ}\text{C}$	I_F	30	mA
Surge forward current per diode	$t_p \leq 10\text{ }\mu\text{s}$	I_{FSM}	0.5	A
Power dissipation per diode	$T_{amb} \leq 85\text{ }^{\circ}\text{C}$	P_V	100	mW
Junction temperature		T_j	125	$^{\circ}\text{C}$
Operating temperature range		T_{amb}	- 40 to + 100	$^{\circ}\text{C}$
Storage temperature range		T_{stg}	- 55 to + 100	$^{\circ}\text{C}$
Soldering temperature	$t \leq 5\text{ s}$	T_{sd}	260	$^{\circ}\text{C}$
Thermal resistance junction/ ambient	mounted on PC board (pad size > 16 mm ²)	R_{thJA}	400	K/W

Optical and Electrical Characteristics

$T_{amb} = 25\text{ }^{\circ}\text{C}$, unless otherwise specified

Red

Parameter	Test condition	Symbol	Min	Typ.	Max	Unit
Luminous intensity	$I_F = 20\text{ mA}$	I_V	40		125	mcd
Dominant wavelength	$I_F = 20\text{ mA}$	λ_d		630		nm
Peak wavelength	$I_F = 20\text{ mA}$	λ_p		643		nm
Angle of half intensity	$I_F = 20\text{ mA}$	ϕ		± 60		deg
Forward voltage	$I_F = 20\text{ mA}$	V_F		1.9	2.6	V
Reverse voltage	$I_R = 10\text{ }\mu\text{A}$	V_R	5			V
Junction capacitance	$V_R = 0, f = 1\text{ MHz}$	C_j		15		pF

Yellow

Parameter	Test condition	Symbol	Min	Typ.	Max	Unit
Luminous intensity	$I_F = 20\text{ mA}$	I_V	40		200	mcd
Dominant wavelength	$I_F = 20\text{ mA}$	λ_d	581	588	594	nm
Peak wavelength	$I_F = 20\text{ mA}$	λ_p		590		nm
Angle of half intensity	$I_F = 20\text{ mA}$	ϕ		± 60		deg
Forward voltage	$I_F = 20\text{ mA}$	V_F		2.0	2.6	V
Reverse voltage	$I_R = 10\text{ }\mu\text{A}$	V_R	5			V
Junction capacitance	$V_R = 0, f = 1\text{ MHz}$	C_j		15		pF

Typical Characteristics ($T_{amb} = 25\text{ }^\circ\text{C}$ unless otherwise specified)

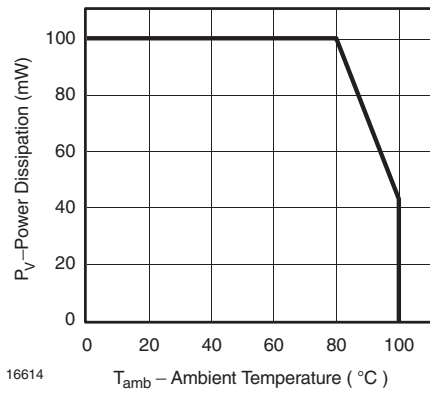

Figure 1. Power Dissipation vs. Ambient Temperature

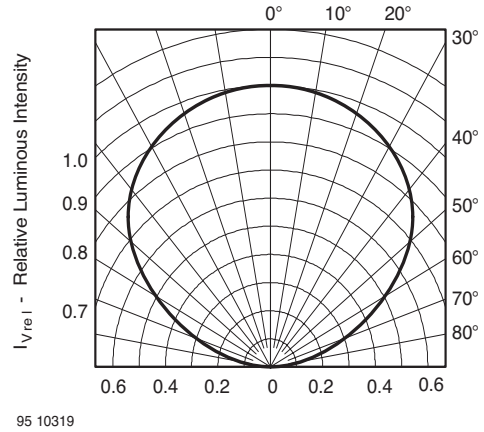

Figure 4. Rel. Luminous Intensity vs. Angular Displacement

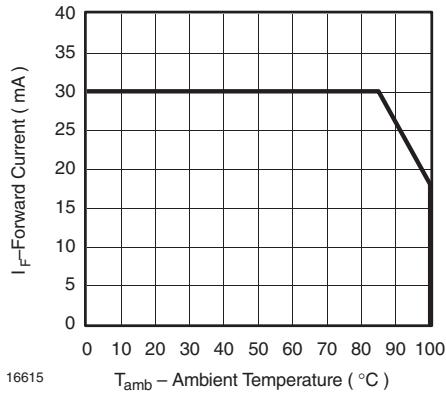

Figure 2. Forward Current vs. Ambient Temperature for InGaN

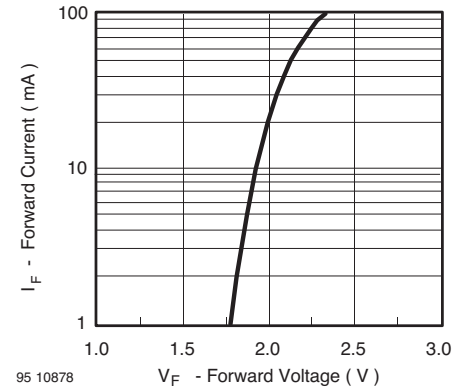

Figure 5. Forward Current vs. Forward Voltage

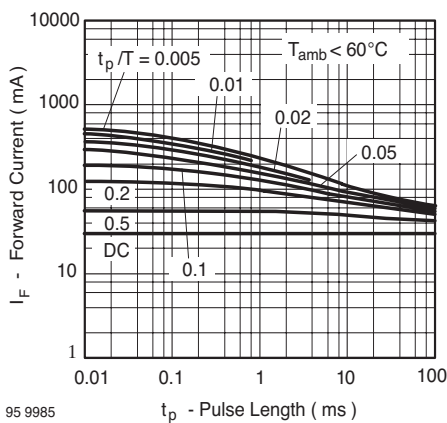

Figure 3. Pulse Forward Current vs. Pulse Duration

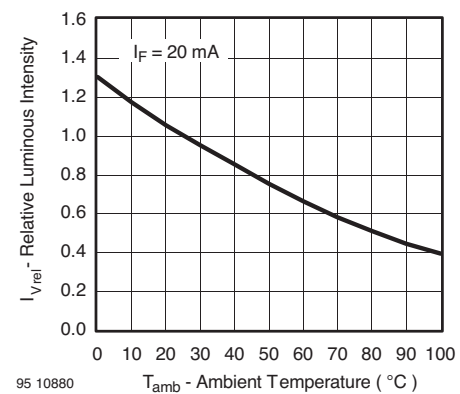

Figure 6. Rel. Luminous Intensity vs. Ambient Temperature

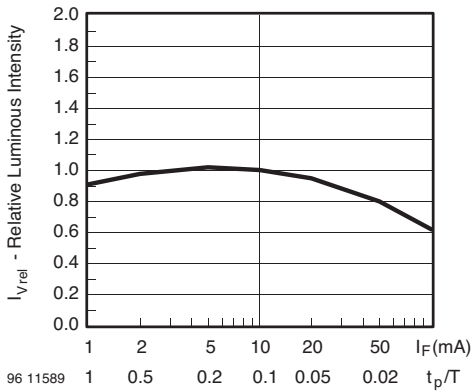

Figure 7. Rel. Lumin. Intensity vs. Forw. Current/Duty Cycle

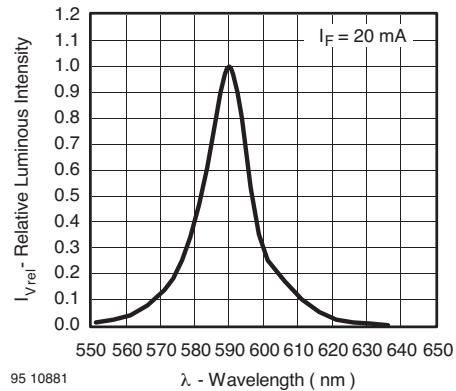

Figure 10. Relative Intensity vs. Wavelength

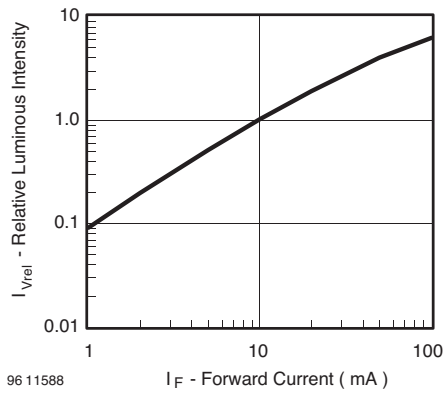

Figure 8. Relative Luminous Intensity vs. Forward Current

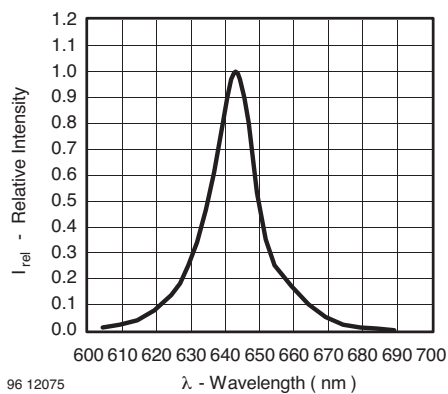
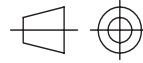
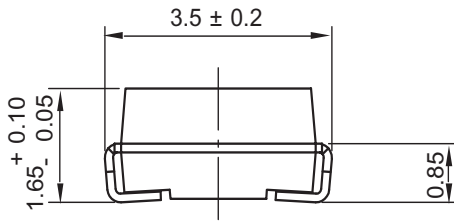
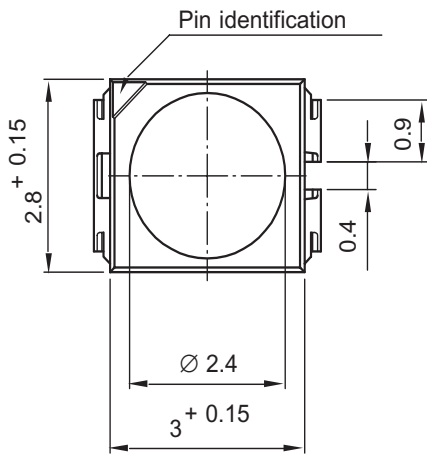

Figure 9. Relative Intensity vs. Wavelength

Package Dimensions in mm



technical drawings
according to DIN
specifications



Drawing-No. : 6.541-5054.01-4
 Issue: 1; 19.02.04

Mounting Pad Layout

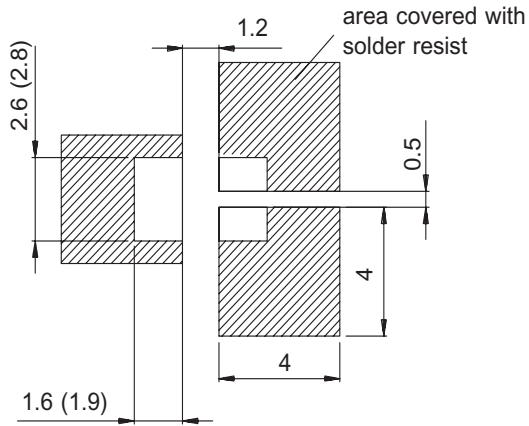

Dimensions: IR and Vaporphase
 (Wave Soldering)

16276

Ozone Depleting Substances Policy Statement

It is the policy of **Vishay Semiconductor GmbH** to

1. Meet all present and future national and international statutory requirements.
2. Regularly and continuously improve the performance of our products, processes, distribution and operating systems with respect to their impact on the health and safety of our employees and the public, as well as their impact on the environment.

It is particular concern to control or eliminate releases of those substances into the atmosphere which are known as ozone depleting substances (ODSs).

The Montreal Protocol (1987) and its London Amendments (1990) intend to severely restrict the use of ODSs and forbid their use within the next ten years. Various national and international initiatives are pressing for an earlier ban on these substances.

Vishay Semiconductor GmbH has been able to use its policy of continuous improvements to eliminate the use of ODSs listed in the following documents.

1. Annex A, B and list of transitional substances of the Montreal Protocol and the London Amendments respectively
2. Class I and II ozone depleting substances in the Clean Air Act Amendments of 1990 by the Environmental Protection Agency (EPA) in the USA
3. Council Decision 88/540/EEC and 91/690/EEC Annex A, B and C (transitional substances) respectively.

Vishay Semiconductor GmbH can certify that our semiconductors are not manufactured with ozone depleting substances and do not contain such substances.

**We reserve the right to make changes to improve technical design
and may do so without further notice.**

Parameters can vary in different applications. All operating parameters must be validated for each customer application by the customer. Should the buyer use Vishay Semiconductors products for any unintended or unauthorized application, the buyer shall indemnify Vishay Semiconductors against all claims, costs, damages, and expenses, arising out of, directly or indirectly, any claim of personal damage, injury or death associated with such unintended or unauthorized use.

Vishay Semiconductor GmbH, P.O.B. 3535, D-74025 Heilbronn, Germany
Telephone: 49 (0)7131 67 2831, Fax number: 49 (0)7131 67 2423