

TO.system elektronik GmbH

SPECIFICATIONS

Type:NTM244P61

(Type Of TOSHIBA:TLX-1741-C3B)

Approval Signature

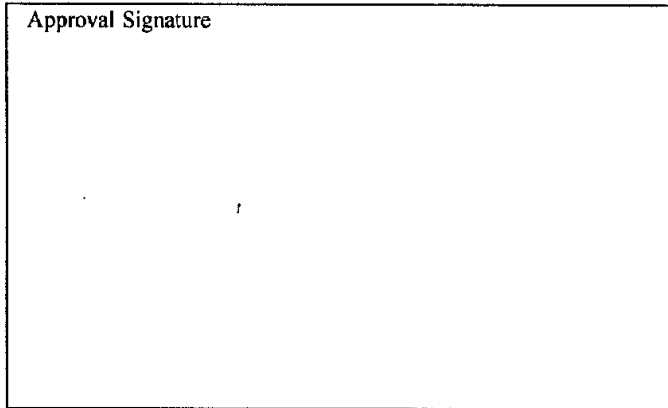

NIPPON SHEET GLASS

APPR.	CHECK

NANOX CO.

APPR.	CHECK	DRAWING

NIPPON SHEET GLASS CO.,LTD
DISPLAY DEVICE GROUP
15-21,1-CHOME,SHIMOMARUKO
OHTAKU,TOKYO 146-0092 JAPAN
TEL:03-5482-3631
FAX:03-5482-3588
(MANUFACTURE:NANOX CORP.)

ISSUED DATE

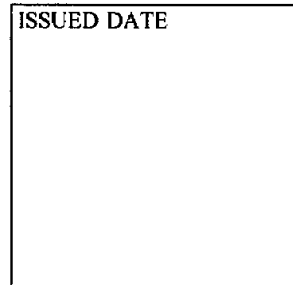

1. GENERAL SPECIFICATIONS

Item	Contents
Display Contents [pixels]	240(W)×128(H)
Dimensional Outline [mm]	170.0(W)×103.0(H)×14.0 max(D)
Display mode	Transmissive Type (Viewing Direction 6 o'clock: $\phi=0^\circ$)
Surface Treatment	Anti glare with hard coat on LCD surface
Circuits	X-Driver, Y-Driver, Power supply circuit, LCD Controller(16963C), RAM(8k bytes)
Interface	CE, WR, RD, C/D, RESET, Data(D ₀ ~D ₇)

2. ABSOLUTE MAXIMUM RATINGS



Item	Symbol	Absolute Maximum Ratings		Unit
		min	max	
Supply Voltage	V _{DD}	0	7.0	V
	V _{DD} -V _{EE}	0	24.0	
FL Driving Voltage ⁽¹⁾	V _{FL}	—	1500	Vrms
Input Voltage	V _{IN}	-0.3	V _{DD} +0.3	V
FL Driving Frequency	f _{FL}	20	80	kHz
FL Input Current	I _{FL}	—	10	mA _{rms}
Storage Temperature ⁽²⁾	T _{stg}	-20	60	°C
Operating Temperature ⁽²⁾	T _{op}	0	50	
Humidity ⁽²⁾	—	10	90	

Note ⁽¹⁾: One minute max.

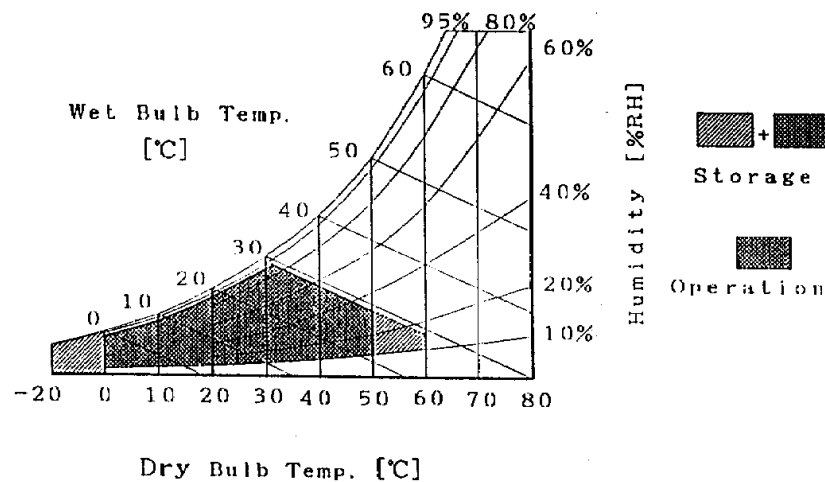
Note ⁽²⁾: Wet bulb temperature should be 29°C max., and no condensation of water.

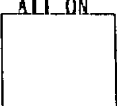

3. ELECTRICAL SPECIFICATIONS (Conditions : Ta=25°C)

Item	Symbol	Conditions	Specifications			Unit
			min	typ	max	
Supply Voltage	V_{DD}	—	4.75	5.0	5.25	V
	$V_{DD}-V_{EE}$	—	17.5	18.5	19.5	
FL Driving Voltage	V_{FL}	—	—	300	350	Vrms
FL Input Current ⁽³⁾	I_{FL}	—	4.0	5.0	7.0	mArms
FL Driving frequency	f_{FL}	—	—	30	35	k Hz
FL Starting Voltage ⁽⁴⁾	V_{FLS}	Ta=0°C	900	—	—	Vrms
Input Voltage	V_{IH}	$V_{DD}=5.0\text{ V}$	2.8	—	5.0	V
	V_{IL}		0	—	0.8	
Output Voltage	V_{OH}	$V_{DD}=5.0\text{ V}$	4.7	—	5.0	V
	V_{OL}		0	—	0.3	
Current consumption (Typical case)	I_{DD}		—	9.0	13.5	mA
	$-I_{EE}$		—	2.0	3.0	
Current consumption (Maximum case)	I_{DD}		—	12.0	18.0	mA
	$-I_{EE}$		—	2.5	4.0	

Note ⁽³⁾: Life time of backlight will change according to the FL input current.

⁽⁴⁾: FL Starting Voltage should be 1300 V_{o-p} min..

⁽⁵⁾: FL Driving Frequency should be decided in order to prevent flickering with the frame frequency of LCD.

Power Supply for Contrast Control

Contrast control power supply V_{EE} shall be variable for contrast and viewing angle control, and for temperature compensation. Recommended V_{EE} (typical value) is as follows at each temperature.

Temperature(°C)	V_{EE} (V) (typ)
0	-15.0
25	-13.5
50	-11.6

4. MECHANICAL SPECIFICATIONS

Item	Specifications	Unit	Note
Display Contents	240(W)×128(H)	—	Ref. page 7
Pixel Pitch	0.50(W)×0.50(H)	mm	Ref. page 7
Pixel Size	0.47(W)×0.47(H)	mm	Ref. page 7
Dimensional Outline	170.0(W)×103.0(H)×14.0 max(D)	mm	Ref. page 6
Viewing Area	126.0(W)×70.0(H)	mm	Ref. page 6
Active Area	119.97(W)×63.97(H)	mm	Ref. page 6
Weight	245(typ)	g	—————

5. OPTICAL SPECIFICATIONS ^(*)

(Ta=25°C, V_{DD}=5.0 V, V_{EE}:At the voltage for K_{MAX} between -12.5V to -14.5V.)

Item	Symbol	Conditions	Specifications			Unit
			min	typ	max	
Viewing Angle ⁽⁷⁾	θ_u	$\phi = 0^\circ, K \geq 1.3$	40	—	—	deg.
	θ_H	$\phi = 180^\circ, K \geq 1.3$	15	—	—	
Maximum Contrast Ratio ⁽⁸⁾	K	$\phi = 0^\circ, \theta = 0^\circ$	2.0	3.5	—	—
Response time ⁽⁹⁾	τ_r	$\phi = 0^\circ, \theta = 0^\circ$	—	200	350	ms
	τ_d		—	200	350	
Luminance ^{(10) (11)}	L	$\phi = 0^\circ, \theta = 0^\circ$ I _{FL} =5.0mA _{rms}	50	90	—	cd/m ²

Note⁽⁶⁾: Definition of ϕ , θ_H and θ_U

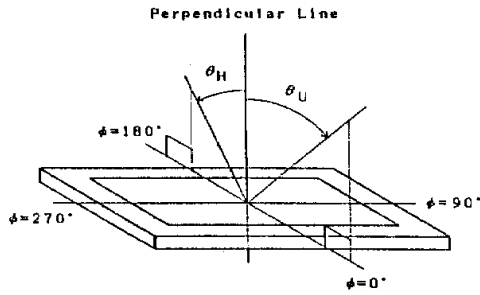

Note⁽⁴⁾: Definition of Contrast Ratio

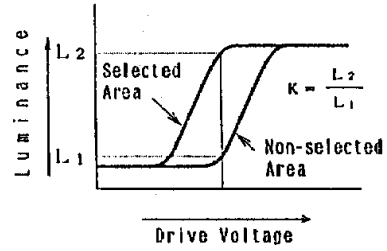

L1 : Luminance of Non-selected Area
L2 : Luminance of Selected Area

Note⁽⁷⁾: Definition of Viewing Angle
Contrast ratio larger than 1.3 can be obtained by adjusting the V_{EE} value.

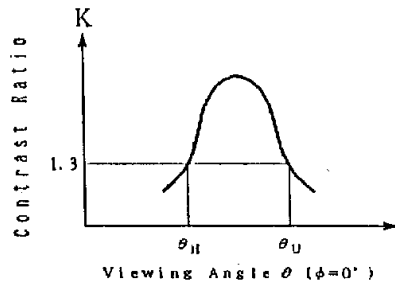

Note⁽⁸⁾: Definition of Turn ON time and Turn OFF time.

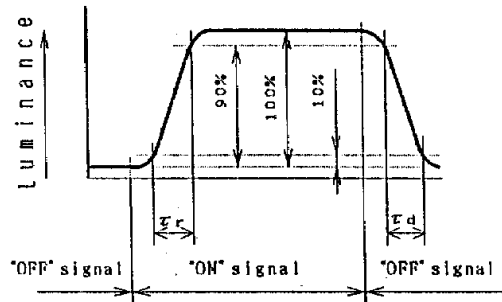

Note⁽¹⁰⁾: Luminance of the LCD surface is measured in the dark room. And luminance is measured after 20 minutes for FL turn on, and adjusted to best contrast.

Note⁽¹¹⁾: Luminance is measured by using recommended FL inverter CXA-M10L(TDK)

6. DIMENSIONS
6.1 Dimensional Outline

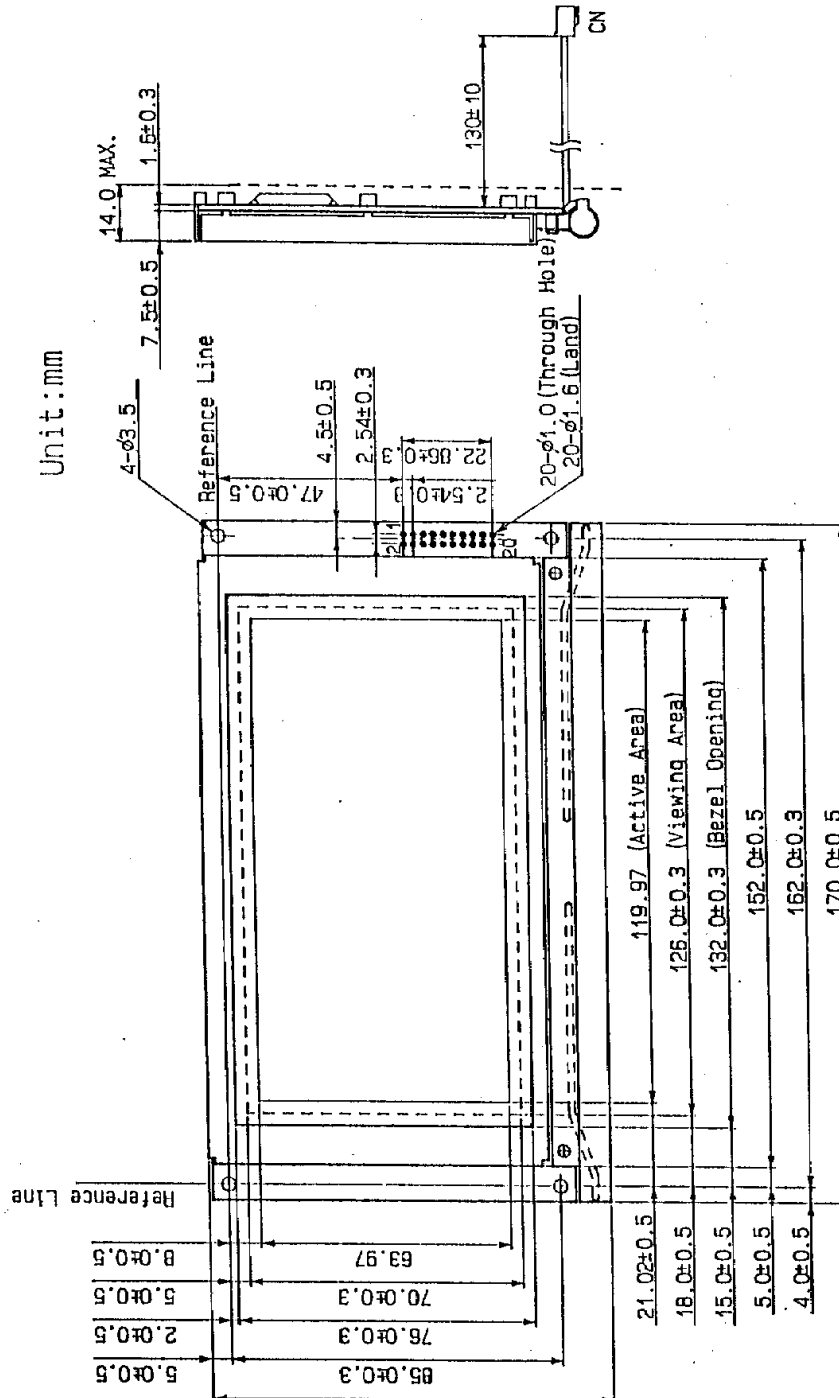

6.2 Display Size

Unit:mm

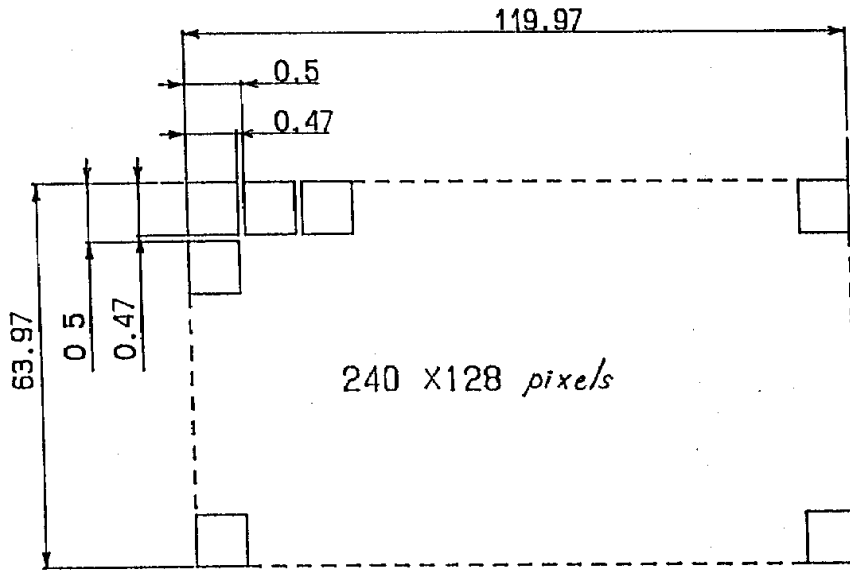

7. INTERFACE

7.1 Interface Pin Connection

Pin No.	Signal	Function
1	FGND	Frame Ground (Connected to Metal Bezel)
2	GND	Ground (Signal Ground)
3	V _{DD}	Power Supply for Logic (4.5V)
4	V _{EE}	Power Supply for LCD Drive (Should be Variable)
5	\overline{WR}	Data Write (Write data to the Module at "L")
6	\overline{RD}	Data Read (Read data from the Module at "L")
7	\overline{CE}	Chip Enable for the Module
8	C/ \overline{D}	\overline{WR} ="L"; C/ \overline{D} ="H": Command Write, C/ \overline{D} ="L": Data Write \overline{RD} ="L"; C/ \overline{D} ="H": Status Read, C/ \overline{D} ="L": Data Read
9	NC	No Connection
10	\overline{RESET}	Module Reset (Controller Reset)
11	D0	Data Input/ Output(LSB)
12	D1	Data Input/ Output
13	D2	Data Input/ Output
14	D3	Data Input/ Output
15	D4	Data Input/ Output
16	D5	Data Input/ Output
17	D6	Data Input/ Output
18	D7	Data Input/ Output(MSB)
19	FS	Fonts Select connect to V _{DD} :6×8 Pixels/Character GND :8×8 Pixels/Character
20	RV	Reverse connect to V _{DD} :Positive Mode GND :Negative Mode

7.2 Block Diagram

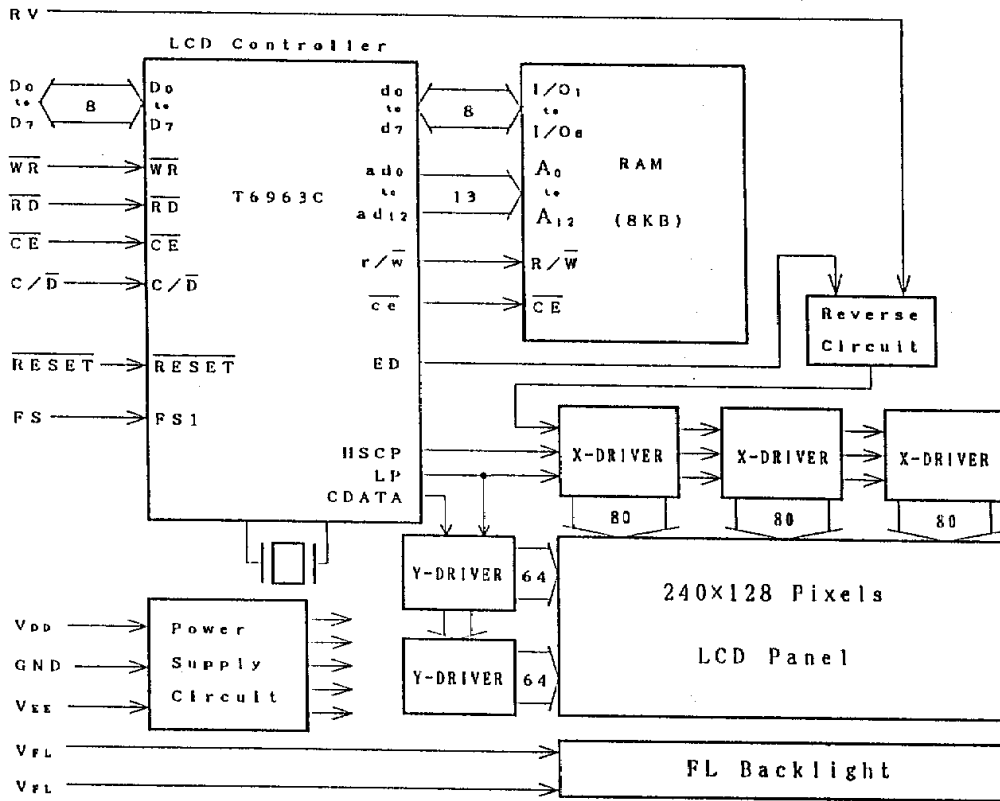

7.3 Timing Specifications

Item	Symbol	Specifications		Unit
		Min.	Max.	
C/ \bar{D} Set Up Time	t_{CDS}	100	—	ns
C/ \bar{D} Hold Time	t_{CDH}	10	—	
\overline{CE} , \overline{RD} , \overline{WR} Pulse Width	t_{CE} , t_{RD} , t_{WR}	80	—	
Data Set Up Time	t_{DS}	80	—	
Data Hold Time	t_{DH}	40	—	
Access Time	t_{ACC}	—	150	
Output Hold Time	t_{OH}	10	50	

Conditions: $V_{DD}=5.0 \pm 0.25V$, $GND=0V$, $T_a=0$ to $50^\circ C$

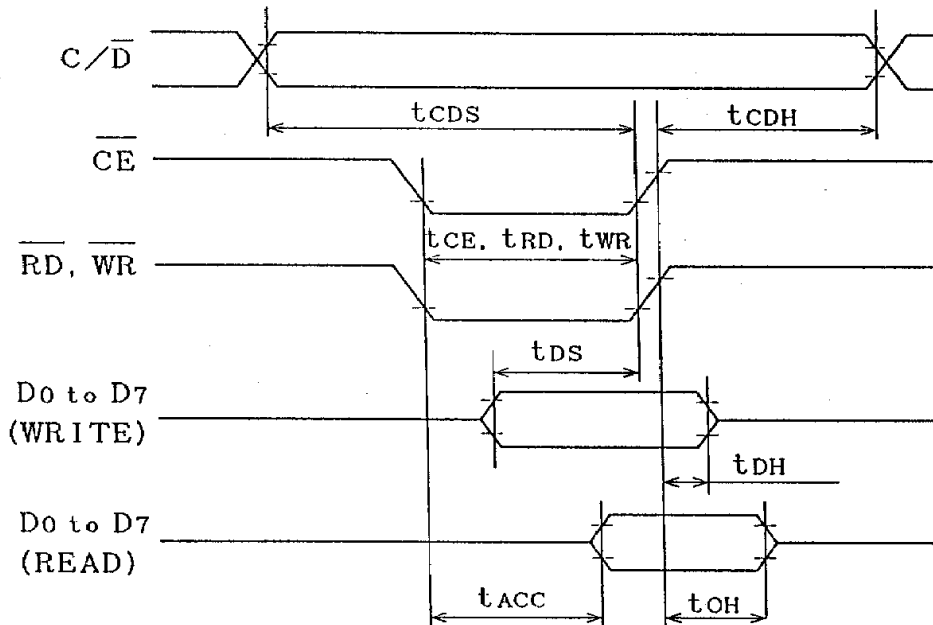

7. 4 Memory Address and Display Position

• In case of 6 × 8 Pixels/Character

Relationship between display memory address and display position on LCD module is defined in the following map. Text home address TH, Number of text area TA=28H(HEX.), Graphic home address GH and Number of graphic area GA=28H(HEX.) are defined by "Internal RAM Write" command. TH and GH can be defined in memory area, but all memory address should be located within 0000H to 1FFFH (8K byte memory area).

[Text Display]

TH	TH+1H		TH+26H	TH+27H	16 Lines
TH+TA	TH+TA+1H		TH+TA+26H	TH+TA+27H	
TH+14TA	TH+14TA+1H		TH+14TA+26H	TH+14TA+27H	
TH+15TA	TH+15TA+1H		TH+15TA+26H	TH+15TA+27H	
40 Characters					

[Graphic Display]

GH	GH+1H		GH+26H	GH+27H	128 Pixels
GH+GA	GH+GA+1H		GH+GA+26H	GH+GA+27H	
GH+126GA	GH+126GA+1H		GH+126GA+26H	GH+126GA+27H	
GH+127GA	GH+127GA+1H		GH+127GA+26H	GH+127GA+27H	
40 x 6 Pixels					

Note. : In case of graphic display,

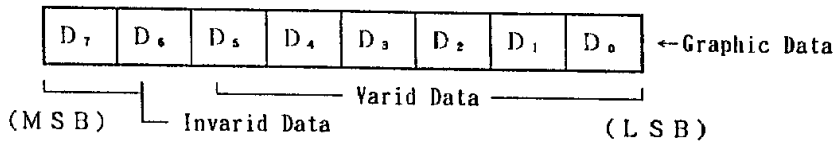

• In case of 8 × 8 Pixels/Character

Relationship between display memory address and display position on LCD module is defined in the following map. Text home address TH, Number of text area TA=1EH(HEX.), Graphic home address GH and Number of graphic area GA=1EH(HEX.) are defined by "Internal RAM Write" command. TH and GH can be defined in memory area, but all memory address should be located within 0000H to 1FFFH (8K byte memory area).

[Text Display]

TH	TH+1H		TH+1CH	TH+1DH	} 16 Lines
TH+TA	TH+TA+1H		TH+TA+1CH	TH+TA+1DH	
TH+14TA	TH+14TA+1H		TH+14TA+1CH	TH+14TA+1DH	
TH+15TA	TH+15TA+1H		TH+15TA+1CH	TH+15TA+1DH	
30 Characters					

[Graphic Display]

GH	GH+1H		GH+1CH	GH+1DH	} 128 Pixels
GH+GA	GH+GA+1H		GH+GA+1CH	GH+GA+1DH	
GH+126GA	GH+126GA+1H		GH+126GA+1CH	GH+126GA+1DH	
GH+127GA	GH+127GA+1H		GH+127GA+1CH	GH+127GA+1DH	
30 x 8 Pixels					

Note : In case of graphic display,

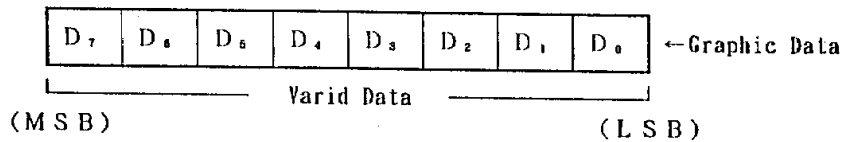

11

7. 5 Pin Setting of LCD Controller

The pin setting of controller LSI(T6963C) is as follows

Display Size	16 Lines(128 Pixels)	MDS="H" MD1="L" MD0="L"
Columns of Display	40 Columns	MD2="L" MD3="H"
Character Font	6 x 8 / 8 x 8 Pixels	FS0="L"
1/ 2 Screen	1 Screen	DUAL="H"

Operating frequency of controller T6963C(f_{osc}) is 5.75 ± 0.5 MHz.

7. 6 RAM Map

Display RAM is built-in the module, and display data is written to this display RAM. Built-in controller LSI T6963C is automatically read from display RAM, and send data to LCD drivers. "Control Word Set" command (Text Home Address Set, Text Area Set, etc.) defines the RAM area which is read by controller LSI, so RAM map can be changed by user's preference. If more than 1 screen can be stored in the RAM, vertical scrolling and paging is easily performed by resetting text home and/ or graphic home address.

This module has 8k byte built-in RAM located at address 000H to1FFFH, and the following is an example of RAM mapping.

*** Example of RAM Map ***

0000H	<table border="1"> <tr> <td>Geaphic RAM Area (0000H to 13FFFH: 5120 byte)</td> <td rowspan="2">Graphic Home Address: 0000H Graphic RAM 6x8 for 30720 Pixels/Character 8x8 for 40960 Pixels/Character</td> </tr> <tr> <td>Attribute RAM Area</td> </tr> <tr> <td>1700H</td> <td>Text RAM Area (1700H to 1BFFFH)</td> <td rowspan="2">Text Home Address: 1700H (Text RAM for 1280 Characters)</td> </tr> <tr> <td>1C00H</td> <td>CG RAM Area (1C00H to 1FFFFH: 1024 byte)</td> <td>Offset Register Set (D1="03H") (CG RAM for 128 Characters)</td> </tr> <tr> <td>1FFFH</td> <td></td> <td></td> </tr> </table>	Geaphic RAM Area (0000H to 13FFFH: 5120 byte)	Graphic Home Address: 0000H Graphic RAM 6x8 for 30720 Pixels/Character 8x8 for 40960 Pixels/Character	Attribute RAM Area	1700H	Text RAM Area (1700H to 1BFFFH)	Text Home Address: 1700H (Text RAM for 1280 Characters)	1C00H	CG RAM Area (1C00H to 1FFFFH: 1024 byte)	Offset Register Set (D1="03H") (CG RAM for 128 Characters)	1FFFH		
Geaphic RAM Area (0000H to 13FFFH: 5120 byte)		Graphic Home Address: 0000H Graphic RAM 6x8 for 30720 Pixels/Character 8x8 for 40960 Pixels/Character											
Attribute RAM Area													
1700H		Text RAM Area (1700H to 1BFFFH)	Text Home Address: 1700H (Text RAM for 1280 Characters)										
1C00H	CG RAM Area (1C00H to 1FFFFH: 1024 byte)	Offset Register Set (D1="03H") (CG RAM for 128 Characters)											
1FFFH													
1400H													
1700H													
1C00H													
1FFFH													

Note⁽¹⁾: Above example of RAM map is for "CG ROM Mode".
"CG RAM Mode" is selected, 2048 byte CG RAM area is necessary.
So above RAM map should be relocated.

7. 7 Commuication between CPU and LCD modules

7.7.1 Data Transmission Method

Biult-in LCD controller T6963C is operating asynchronously to CPU clock, and following procedure is required for data transmission between modules and CPU.

(1)Command with 1 byte data

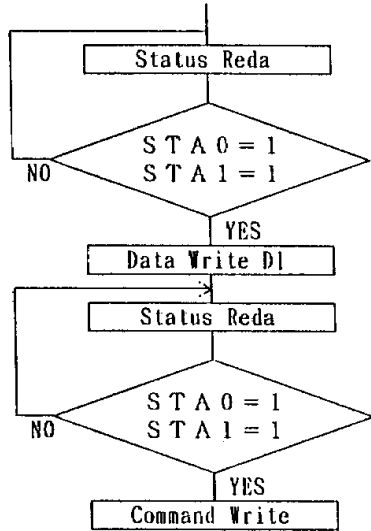

(2)Command with 2 byte data

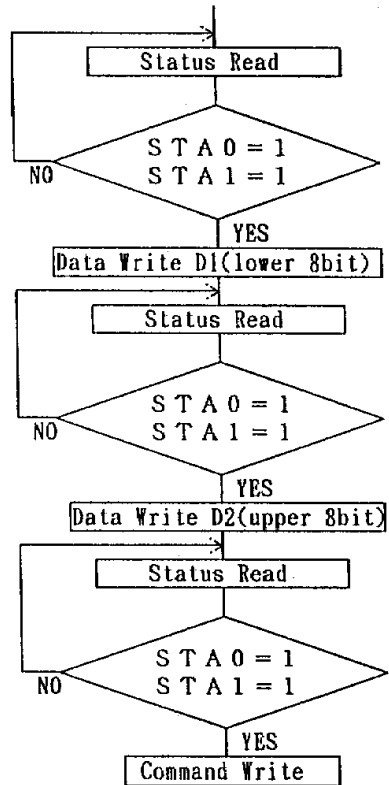

(3)Command with no data

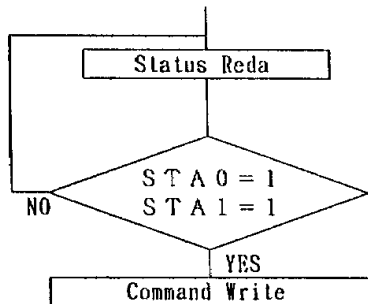

(4)Auto mode(Data Auto Write/Data Auto Reda)

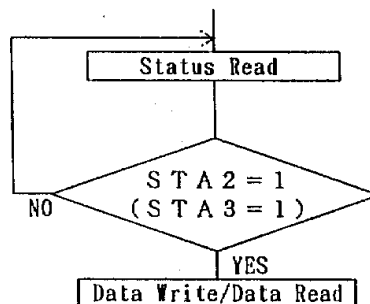

7.7.2 Status read

Status of controller LSI should be checked between all and data in order to complete communication with CPU. Status can be read from 8 bit data lines (D₀ to D₇) by setting C/D="H", RD="L".

STA 0	Check capability of instruction execution	STA0=0 :Disable 1 :Enable
STA 1	Check capability of data read or data write	STA1=0 :Disable 1 :Enable
STA 2	Check capability of data read (Only effective in auto mode)	STA2=0 :Disable 1 :Enable
STA 3	Check capability of data write (Only effective in auto mode)	STA3=0 :Disable 1 :Enable
STA 4	-----	-----
STA 5	Check possibility of controller operation	STA5=0 :Disable 1 :Enable
STA 6	Address pointer is out of graphic area on screen peeking and screen copy command	STA6=1 :Out of graphic area
STA 7	Check the condition of blink	STA7=0 :Display off 1 :Normal display

(Status Register)

STA 7	STA 6	STA 5	STA 4	STA 3	STA 2	STA 1	STA 0
D 7	D 6	D 5	D 4	D 3	D 2	D 1	D 0
MSB				LSB			

7.7.3 Command List

Command	Command code								Description	Execution time (Max.) (Note 1)
	D7	D6	D5	D4	D3	D2	D1	D0		
Pointer Set	0	0	1	0	0	N2	N1	N0	N2 N1 N0 0 0 1 Cursor Pointer Set 0 1 0 Offset Resister Set 1 0 0 Address Pointer Set	Status check
Control Word Set	0	1	0	0	0	0	N1	N0	N1 N0 0 0 Text Home Address Set 0 1 Text Area Set 1 0 Graphic Home Address Set 1 1 Graphic Area Set	Status check
Mode Set	1	0	0	0	CG	N2	N1	N0	CG=0:CG ROM Mode CG=1:CG RAM Mode N2 N1 N0 (Graphic and Text) 0 0 0 "OR" 0 0 1 "EXOR" 0 1 1 "AND" 1 0 0 Text only (attribute capability)	32x1/fOSC
Display Mode	1	0	0	1	N3	N2	N1	N0	N3=0:Graphic display off 1:Graphic display on N2=0:Text display off 1:Text display on N1=0:Cursor display off 1:Cursor display on N0=0:Cursor blink off 1:Cursor blink on	32x1/fOSC
Cursor Pattern Select	1	0	1	0	0	N2	N1	N0	N2, N1, N0 specify the number of cursor lines (Example) N2 N1 N0 0 0 0 1 line cursor (bottom line) 1 1 1 8 line cursor (8x8 pixel cursor)	32x1/fOSC
Data Auto Read/Write	1	0	1	1	0	0	N1	N0	N1 N0 0 0 Data Auto Write Set 0 1 Data Auto Read Set 1 0 Auto Reset After this command, continuous data can be written or read. (address pointer automatically increment)	32x1/fOSC
Data Read/Write	1	1	0	0	0	N2	N1	N0	Data Read/Write command for 1 byte. N2=0:Address Pointer up/down =1:Address Pointer unchanged N1=0:Address Pointer up =1:Address Pointer down N0=0:Data Write =1:Data Read	32x1/fOSC
Screen Peeking	1	1	1	0	0	0	0	0	Transfer display data to data stack for read from CPU.	Status check
Screen Copy	1	1	1	0	1	0	0	0	1 line displayed data which address is indicated by address pointer is copied to graphic RAM area.	Status check
Bit Set/Reset	1	1	1	1	N3	N2	N1	N0	Set/Reset command for a bit in the address pointed by address pointer. N3=0:Bit Reset =1:Bit Set N2, N1, N0 indicated the bit in the pointed address (000 is LSB, and 111 is MSB.)	Status check

Notes 1. Status check between all commands and data is recommended, though execution time for several commands are specified in above command list. For the commands with "Status Check" in execution time, execution time does not specified because it is influenced by internal situation of controller LSI.

7.7.4 Initialization

Initialization of controller LSI T6963C is required for "Mode Set" and "Control Word Set" after power on.

Following is the example of initializing procedure of these modules.

Command	C/D	D7	D6	D5	D4	D3	D2	D1	D0	Hex	Note
Power On	$V_{DD} \geq 4.75V$										
Hard Reset (Use Reset Terminal)	RESET="L" (4~200 μ)										
Mode Set	1	1	0	0	0	0	0	0	0	80H	"OR" mode
Control Word Set	0	0	0	0	0	0	0	0	0	00H	Graphic Home Address 0000H (Refer "3.5 RAM Map")
Graphic Home Position Set	0	0	0	0	0	0	0	0	0	00H	
	1	0	1	0	0	0	0	1	0	42H	Command
Graphic Area Set	0	0	0	1	0	1	0	0	0	28H	6×8 Pixels/Character
	0	0	0	0	0	0	0	0	0	00H	
	0	0	0	0	1	1	1	1	0	1EH	8×8 Pixels/Character
	0	0	0	0	0	0	0	0	0	00H	
	1	0	1	0	0	0	0	1	1	43H	Command
Text Home Position Set	0	0	0	0	0	0	0	0	0	00H	Text Home Address 1700H (Refer "3.5 RAM Map")
	0	0	0	0	1	0	1	1	1	17H	
	1	0	1	0	0	0	0	0	0	40H	Command
	0	0	0	0	0	0	0	0	0	00H	
Text Area Set	0	0	0	1	0	1	0	0	0	28H	6×8 Pixels/Character
	0	0	0	0	0	0	0	0	0	00H	
	0	0	0	0	1	1	1	1	0	1EH	8×8 Pixels/Character
	0	0	0	0	0	0	0	0	0	00H	
	1	0	1	0	0	0	0	0	1	41H	Command
(Initialize End) (Data Write)											
Address Pointer Set	0	0	0	0	0	0	0	0	0	00H	Graphic Home Address 0000H (Refer "3.5 RAM Map")
	0	0	0	0	0	0	0	0	0	00H	
	1	0	0	1	0	0	1	0	0	24H	Command
Data Write (Graphic Data)	0	0	1	0	1	0	1	0	1	28H	Graphic Data
	1	1	1	0	0	0	0	0	0	C0H	Data Write Command
	0	1	0	1	0	1	0	1	0	28H	Graphic Data
	1	1	1	0	0	0	0	0	0	C0H	Data Write Command
	⋮	⋮	⋮	⋮	⋮	⋮	⋮	⋮	⋮	⋮	⋮
Address Pointer Set (Address Pointer ###H)	0	0	0	0	0	0	0	0	0	00H	Text Home Address 1700H (Refer "3.5 RAM Map")
	0	0	0	0	1	0	1	1	1	17H	
	1	0	0	1	0	0	1	0	0	24H	Command
Data Write (Text Data)	(T)	0	0	0	1	1	0	1	0	34H	CG ROM Data
		1	1	1	0	0	0	0	0	C0H	Data Write Command
	(O)	0	0	0	1	0	1	1	1	2FH	CG ROM Data
		1	1	1	0	0	0	0	0	C0H	Data Write Command
	⋮	⋮	⋮	⋮	⋮	⋮	⋮	⋮	⋮	⋮	⋮
Display Mode Set	1	1	0	0	1	1	1	0	0	9CH	Text/Graphic On

7.7.5 Character Generator Code

上位 \ 下位	0	1	2	3	4	5	6	7
0								
1								
2								
3								
4								
5								
6								
7								
8								
9								
A								
B								
C								
D								
E								
F								

8. MARKING

Followings should be marked on the each modules.

Type Number
Manufacturer's name (Nanox)
Country of origin
Manufacturing lot number

9. QUALITY

9.1 Inspection AQL

Total of Major Defects : AQL 1.5 %
Total of Minor Defects : AQL 4.0 %
Sampling Method : ANSI/ASQC Z1.4 (Level II)

9.2 Test Conditions

Ambient Temperature : 25 ± 5 °C
Humidity : 65 ± 20 %RH
Illumination :

Visual inspection shall be performed under the single fluorescent lamp (20W) with about 50 cm distance from LCD module by naked eyes with 30 cm distance from the LCD module.

Viewing angle for inspection should be within viewing angle specified in this specification. Defects which is visible only in the surface glare shall be disregarded.

Operating conditions :

Unless otherwise specified, LCD module shall be operated by the rating value (typical value).

9.3 Dimensions

Item	Description	Class
Important Dimensions	Dimensional outline, Dimension between the mounting holes	Major
Others	Dimensions specified in this specification	Minor

9.4 Appearance

Item	Description	Class
PCB Appearance	*Pattern peeling, snapping, electrically short.	Major
	*Conductive pattern missing or pinhole larger than 30% of original width *Repair portion on PCB does not covered by epoxy resin.	Minor
Soldering	*Cold solder joint, lead move when pulled.	Major
	*Misalignment of pad and lead of flat package LSI (larger than 1/2 width of LSI lead).	Minor
Bezel, connectors	*Distinct stain, rust or scratch.	Minor
Black and White spots/line Contrast spots/line	Dust, foreign materials attached on the display surface is defined as "Black and White spot/lines" or "Contrast spots/lines" in 9.5. If these material is easily wiped off, they should be disregarded.	Minor
Display color/ Newton ring	*Distinct display color unevenness and newton ring.	Minor

9.5 Operational

Item	Description	Class																								
Function	No display, Malfunction	Major																								
Display Quality	Missing Line, missing pixel	Major																								
	Pinhole/pattern deformation larger than 0.3 mm	Minor																								
	Abnormal flickering/Waving observed	Minor																								
Uniformity	Uniformity of background/display	Minor																								
Black, White and Bright spots/line Note ⁽¹⁴⁾	<table border="0"> <tr> <td>*Average diameter(mm)</td> <td colspan="2">Acceptable No.</td> </tr> <tr> <td>$D \leq 0.2$</td> <td colspan="2">neglect</td> </tr> <tr> <td>$0.2 < D \leq 0.3$</td> <td colspan="2">$N \leq 5$</td> </tr> <tr> <td>$0.3 < D$</td> <td colspan="2">$N = 0$</td> </tr> <tr> <td>*line width(mm)</td> <td colspan="2">Length(mm)</td> </tr> <tr> <td>$W \leq 0.03$</td> <td>neglect</td> <td>good</td> </tr> <tr> <td>$0.03 < W \leq 0.05$</td> <td>$L \leq 2$</td> <td>$N \leq 5$</td> </tr> <tr> <td>$0.05 < W \leq 0.07$</td> <td>$L \leq 1$</td> <td>$N \leq 5$</td> </tr> </table>	*Average diameter(mm)	Acceptable No.		$D \leq 0.2$	neglect		$0.2 < D \leq 0.3$	$N \leq 5$		$0.3 < D$	$N = 0$		*line width(mm)	Length(mm)		$W \leq 0.03$	neglect	good	$0.03 < W \leq 0.05$	$L \leq 2$	$N \leq 5$	$0.05 < W \leq 0.07$	$L \leq 1$	$N \leq 5$	Minor
*Average diameter(mm)	Acceptable No.																									
$D \leq 0.2$	neglect																									
$0.2 < D \leq 0.3$	$N \leq 5$																									
$0.3 < D$	$N = 0$																									
*line width(mm)	Length(mm)																									
$W \leq 0.03$	neglect	good																								
$0.03 < W \leq 0.05$	$L \leq 2$	$N \leq 5$																								
$0.05 < W \leq 0.07$	$L \leq 1$	$N \leq 5$																								
Contrast spots/ lines (low contrast spots/lines, defects of reflector) Note ⁽¹⁴⁾	<table border="0"> <tr> <td>*Average diameter</td> <td colspan="2">Acceptable No.</td> </tr> <tr> <td>$D \leq 0.5$ (mm)</td> <td colspan="2">good</td> </tr> <tr> <td>$0.5 < D \leq 1.0$</td> <td colspan="2">$N \leq 5$</td> </tr> <tr> <td>$1.0 < D$</td> <td colspan="2">$N = 0$</td> </tr> <tr> <td>*Contrast line width</td> <td>Length</td> <td>Acceptable No.</td> </tr> <tr> <td>$W \leq 0.05$(mm)</td> <td>neglect</td> <td>good</td> </tr> <tr> <td>$0.05 < W \leq 0.07$</td> <td>$L \leq 2.0$(mm)</td> <td>$N \leq 5$</td> </tr> </table>	*Average diameter	Acceptable No.		$D \leq 0.5$ (mm)	good		$0.5 < D \leq 1.0$	$N \leq 5$		$1.0 < D$	$N = 0$		*Contrast line width	Length	Acceptable No.	$W \leq 0.05$ (mm)	neglect	good	$0.05 < W \leq 0.07$	$L \leq 2.0$ (mm)	$N \leq 5$	Minor			
*Average diameter	Acceptable No.																									
$D \leq 0.5$ (mm)	good																									
$0.5 < D \leq 1.0$	$N \leq 5$																									
$1.0 < D$	$N = 0$																									
*Contrast line width	Length	Acceptable No.																								
$W \leq 0.05$ (mm)	neglect	good																								
$0.05 < W \leq 0.07$	$L \leq 2.0$ (mm)	$N \leq 5$																								
Current Consumption	Out of specifications	Minor																								
Contrast ratio/ viewing angle	Out of specifications	Minor																								
Response time	Out of specifications	Minor																								
Backlight	No backlighting	Major																								
	Uniformity of backlight brightness	Minor																								

Note⁽¹⁴⁾: Average diameter D is defined as follows;

$$D = \frac{a + b}{2} \text{ [mm]}$$

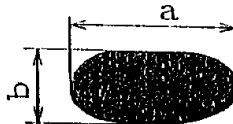

10. RELIABILITY

The LCD module shall have no failure in the following reliability tests.

Test Item	Test Conditions	Note
High Temperature Storage	60°C, 200hrs	2
Low Temperature Storage	-20°C, 200hrs	2
Humidity Storage	60°C, 70%RH, 200hrs	1, 2
High Temperature Operation	50°C, $V_{DD}=5.0V$, 200hrs	2
Low Temperature Operation	0°C, $V_{DD}=5.0V$, 200hrs	1, 2
Temperature Cycling	-20°C \rightleftharpoons 60°C 2hr. 30min. 2hr. 5 cycles	1, 2
Mechanical Shock	50G, 20ms X, Y, Z each directions(1time)	—
Mechanical Vibration	10 to 250 to 10Hz sweep, 0.5G, 30minutes X, Y, Z each directions	—

Note 1. The module should not have condensation of water on the module.

Note 2. The module should be inspected after 1 hour storage in normal conditions(15to35°C, 45to65%RH)

We hope to correct these discription as follows:

1. Current consumption is more than specified value.
2. Function of the module is not maintained.
3. There is visible degradation of apperance and display quality.
4. Contrast ratio is less than 50% of specified minimum value.
5. Brightness is less than 50% of specified minimum value.

MTTF: LCD Module 50000hr (Typ)

MTTF:FL-Backlight 10,000hr

1 1. W A R R A N T Y

11.1 Incoming Inspection

Customer has the right to perform incoming inspection for the lot acceptance/rejection. Lot rejection should be informed to NSG within a month from the shipping date.

Customer also has the right to reject any individual display that does not function properly, or does not mechanically fit or does not meet cosmetic specification described in this specification.

11.2 Warranty Period

NSG warrants for a period of 15 months from the shipping date when stored or used under normal conditions.

1 2. I N S T A L L A T I O N

For installation of the module, use four mounting holes located at the corner of the bezel. The Bezel is not intended to be used as a cosmetic purpose. The proper protective cover(lens) over the LCD surface and the proper enclosure are recommended to be attached in order to prevent polarizer surface from scratching or staining. The transparent opening dimensions of protective cover are recommended to be smaller than the viewing area specified in Section 4.

1 3. C a u t i o n a n d H a n d l i n g P r e c a u t i o n

(1) Handling

- (a) Refrain from strong mechanical shock and from applying any force to LCD module.
It may cause misoperation or damage of LCD and FL backlight.
- (b) Note that polarizers are so soft as being easily damaged.
Do not press or scratch these surface with any hard object, and do not put the heavy material on the polarizer.
- (c) If LCD is broken and liquid crystal material flow out, ingestion, inhalation, or contact with skin should be avoided. If liquid crystal material contact with skin, wash immediately with alcohol and rinse thoroughly with water.
- (d) The polarizer laminated to the LCD and adhesives be attacked by organic solvent. When LCD surface become dirty, wipe softly with absorbent cotton wet with petroleum benzine.
- (e) Refrain from discharge of high electro-static voltage.
It will damage CMOS LSI in the module. So, be sure that person handling modules, tools like soldering iron, screw driver and working bench are grounded.
- (f) Be careful not to be struck by electric shock of FL backlight.
- (g) Do not handle with power applied, because high voltage is applied to module.
(especially to CCFL lamp)

(2) Storage

- (a) Do not leave the module in high temperature, especially in high humidity for a long time. It is recommended to store the module where the temperature is in the range of 0°C to 35°C and the humidity is lower than 70%.
- (b) Store the module without exposure to direct sunlight or fluorescent lamp.

(3) Operation

- (a) Do not insert or remove LCD module from main system with power applied.
- (b) Power supplies should always be turned on before the input signals are applied, and the input signals should be turned off before power supplies turned off.
- (c) Following power supply sequence is requested in order to keep better display quality and reliability.

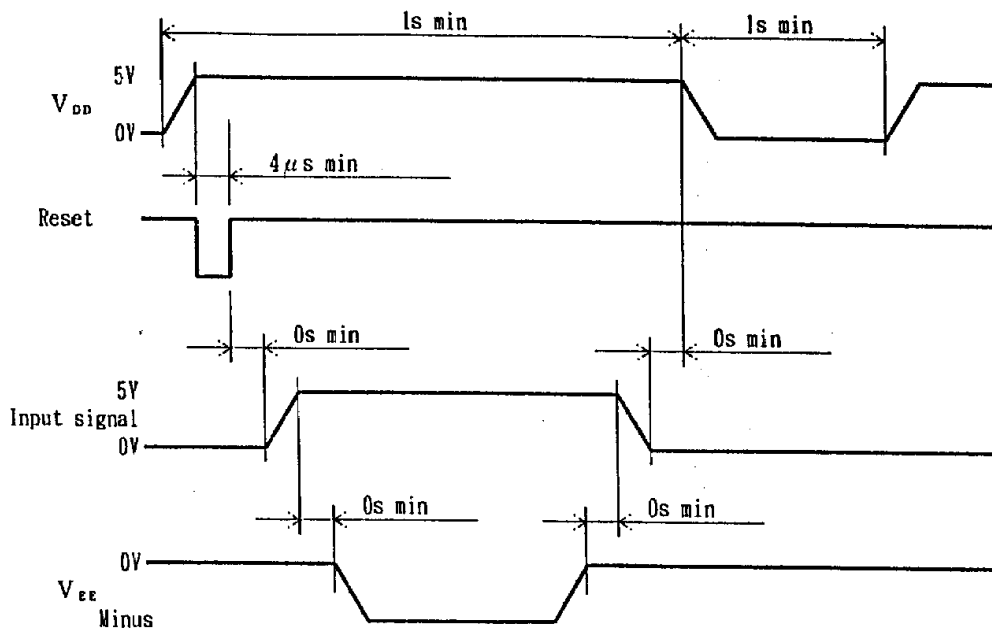

(4) Others!

- (a) Ultra-violet ray cut filter is necessary for outdoor operation.
- (b) Avoid condensation of water, it may cause misoperation or disconnection of electrode.
- (c) Do not exceed the maximum rating values under the worst probable conditions taking into account the supply voltage variation, input voltage variation, variation in part constants, and environmental temperature, etc. otherwise LCD module may be damaged.
- (d) The input current to this LCD module from the system is required to limit its value as listed in the following table. It is because the LCD explained in this data sheet does not incorporate a current limiter, or a circuit with such function, and there may be some possibility of overheat and/or burning of LCD module and its peripheral devices in the system when the module is malfunctioning.

When a fuse is used as a limiter, it is required to confirm its Rated Current and Pre-arcing Time Characteristics in order to match with a system power supply and the LCD module.

The Table below also shows the recommended Rating of a "Quick-arching Fuse" for this purpose.

Power Supply	Required input current to LCD module from the system	Recommended ratings of quick-arching Fuse
V _{DD}	Below 4.0A	0.5A to 1.0A (F1)
V _{EE}	Below 4.0A	0.5A to 1.0A (F2)