



# TS4264

## 150mA Ultra Low Drop Out Voltage Regulator

SOT-223



Pin assignment:

1. Input
2. Ground
3. Output

**High Input Voltage up to 45V**  
**Low Dropout Voltage 0.5V max.**

### General Description

TS4264 is a 5V low-drop fixed-voltage regulator in an SOT-223 package. The IC regulates an input voltage in the range of  $5.5V < V_{in} < 45V$  to  $V_{out}(\text{rated}) = 5.0V$ . The maximum output current is more than 150mA. This IC is designed with short circuit-proof and features temperature protection that disables the circuit at over-temperature.

### Features

- ✧ Fixed output voltage 5V
- ✧ Output voltage tolerance  $\pm 2\%$
- ✧ 150mA current capability
- ✧ Ultra low drop out voltage
- ✧ Very low current consumption
- ✧ Over temperature protection
- ✧ Short-circuit proof
- ✧ Reverse polarity proof
- ✧ Wide temperature range
- ✧ Suitable for use in automotive electronics

### Ordering Information

Part No.	Operating Temp.	Package
TS4264CW50	-40 ~ 150 °C	SOT-223

### Pin Definition and Function

Pin	Symbol	Function
1	Input	Block to ground directly on IC with ceramic capacitor
2	Ground	Ground
3	Output	Block to ground with 10uF capacitor, ESR < 10Ω

### Block Diagram

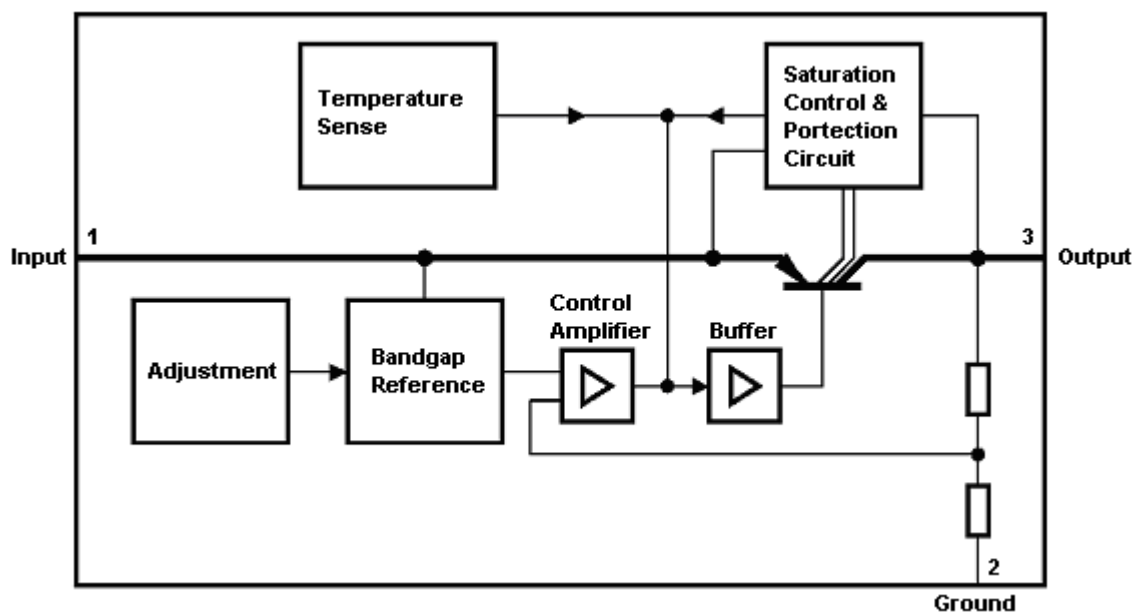



<b>Absolute Maximum Rating</b>			
Parameter	Symbol	Values	Unit
Input Supply Voltage	V <sub>in</sub>	-42 ~ 45	V
Operating Input Voltage	V <sub>in(opr)</sub>	5.5 ~ 45	V
Output Voltage	V <sub>out</sub>	-1 ~ 16	V
Power Dissipation	P <sub>D</sub>	Internally Limited	W
Ground Current	I <sub>GND</sub>	50	mA
Operating Junction Temperature Range	T <sub>J</sub>	-40 ~ +150	°C
Storage Temperature Range	T <sub>STG</sub>	-50 ~ +150	°C

<b>Thermal Performance</b>			
Parameter	Symbol	Values	Unit
Junction to Ambient	R <sub>θja</sub>	80	°C/W
Junction to Case	R <sub>θjc</sub>	18	

<b>Electrical Characteristics</b>					
V <sub>in</sub> = 13.5V, -40 ≤ T <sub>j</sub> ≤ +150, unless otherwise specified.					
Parameter	Conditions	Min	Typ	Max	Unit
Output Voltage	6V ≤ V <sub>in</sub> ≤ 28V, 5mA ≤ I <sub>o</sub> ≤ 100mA	4.9	5.0	5.1	V
Output Current Limited		150	--	--	mA
Line Regulation	6V ≤ V <sub>in</sub> ≤ 28V, I <sub>o</sub> =5mA	--	15	30	mV
Load Regulation	5mA ≤ I <sub>o</sub> ≤ 100mA, V <sub>in</sub> = 6V	--	--	90	mV
Dropout Voltage (note 1)	I <sub>o</sub> =100mA	--	0.25	0.5	V
Current Consumption (I <sub>q</sub> = I <sub>in</sub> – I <sub>out</sub> )	I <sub>o</sub> = 1mA	--	--	400	uA
	I <sub>o</sub> = 100mA	--	10	15	mA
Temperature Stability	I <sub>o</sub> =10mA	--	0.5	--	%
Power Supply Ripple Rejection	f = 100Hz, V <sub>r</sub> = 0.5Vp-p	--	54	--	dB

Note 1: Drop voltage = V<sub>in</sub> – V<sub>out</sub>  
(measured where V<sub>out</sub> has dropped 100mV from the nominal value obtained at V<sub>in</sub>= 13.5V)

## Typical Application Circuit

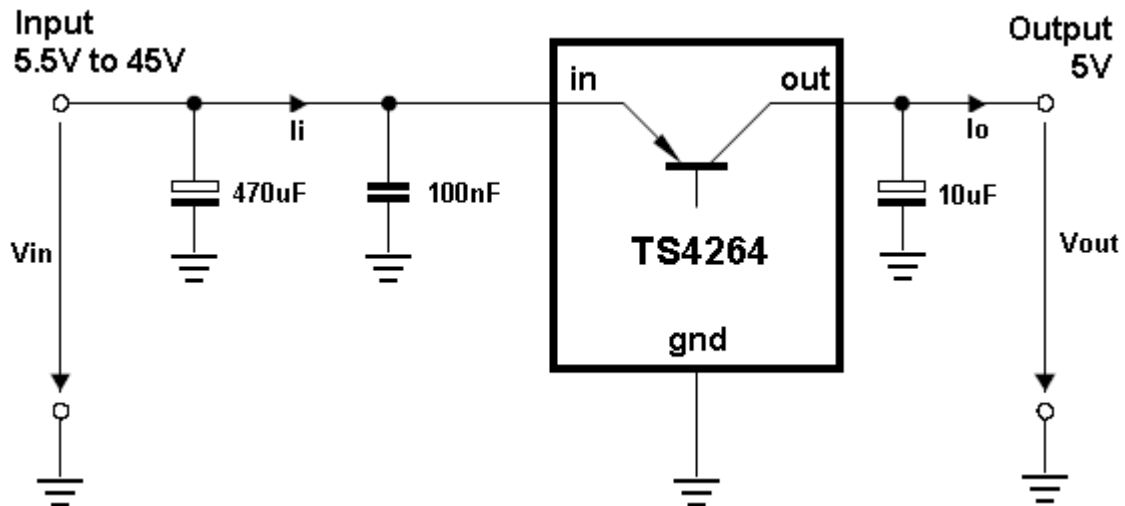

## Application Information

### Dimensioning Information on External Components

The input capacitor  $C_{in}$  is necessary for compensating line influences. Using a resistor of approx.  $1\Omega$  in series with  $C_{in}$ , the oscillating of input inductivity and input capacitance can be clamped. The output capacitor  $C_{out}$  is necessary for the stability of the regulating circuit. Stability is guaranteed at values  $C_{out} \geq 10\mu F$  and an  $ESR \leq 10\Omega$  within the operating temperature range.

### Circuit Description

The control amplifier compares a reference voltage, which is kept highly precise by resistance adjustment, to a voltage that is proportional to the output voltage and drives the base of the series transistor via a buffer. Saturation control, working as a function of load current, prevents any over-saturation of the power element. The IC is additionally protected against overload, over temperature and reverse polarity

## Electrical Characteristics Curve

Figure 1: dropout voltage vs output current

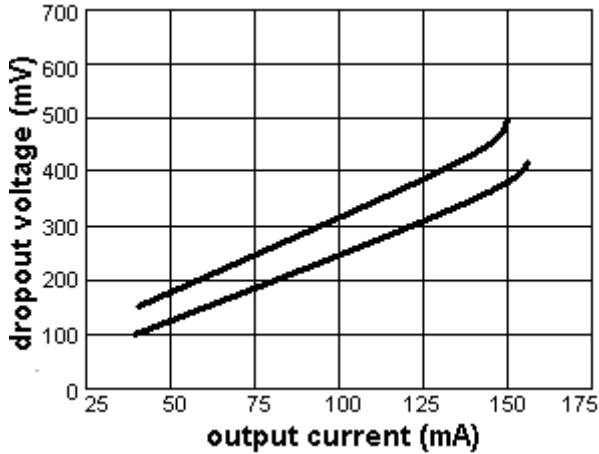

Figure 2: output current vs input voltage

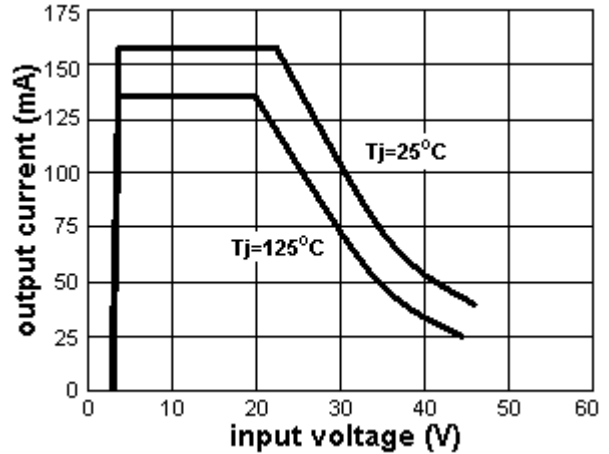

Figure 3: consumption vs output current

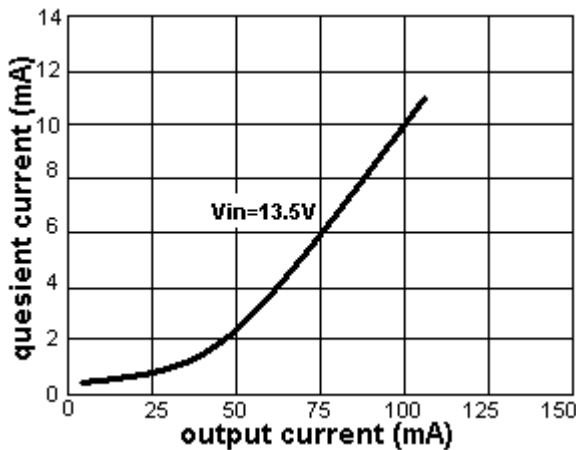

Figure 4: consumption vs output current

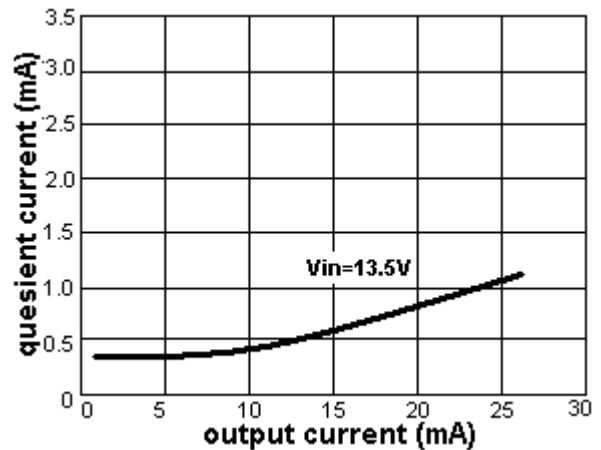

Figure 5: consumption vs input voltage

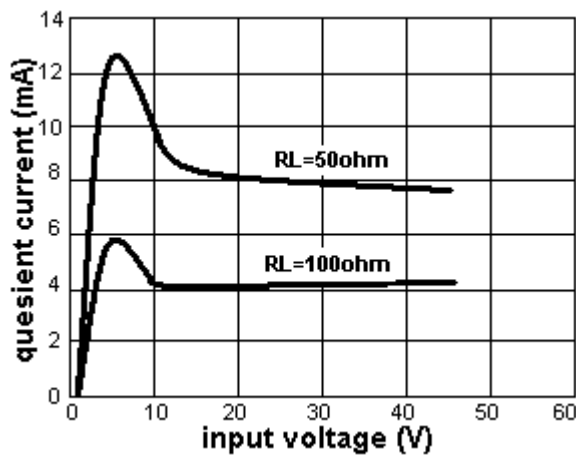
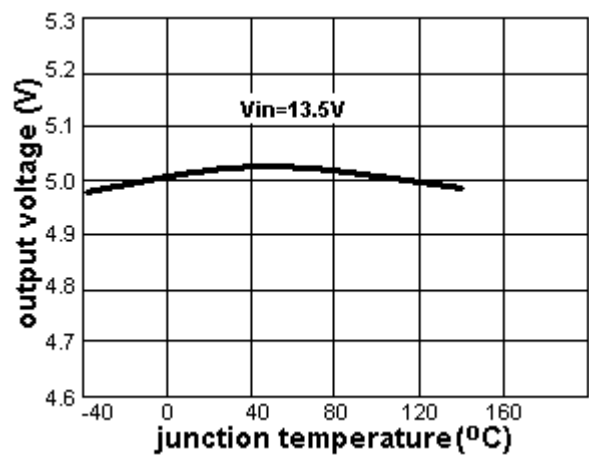
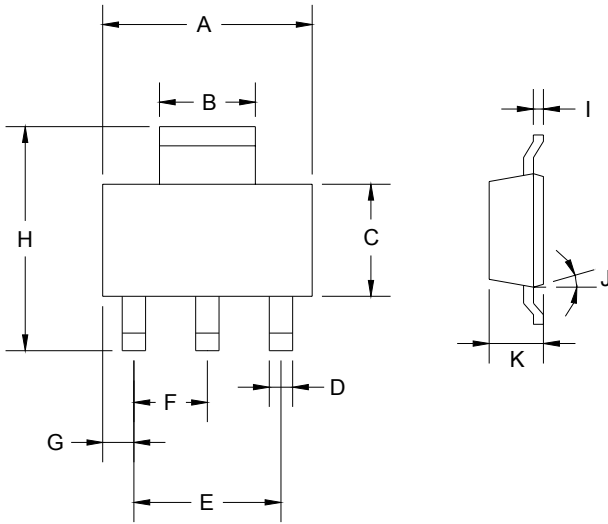

Figure 6: output voltage vs temp.



## SOT-223 Mechanical Drawing



DIM	SOT-223 DIMENSION			
	MILLIMETERS		INCHES	
	MIN	MAX	MIN	MAX
A	6.350	6.850	0.250	0.270
B	2.900	3.100	0.114	0.122
C	3.450	3.750	0.136	0.148
D	0.595	0.635	0.023	0.025
E	4.550	4.650	0.179	0.183
F	2.250	2.350	0.088	0.093
G	0.835	1.035	0.032	0.041
H	6.700	7.300	0.263	0.287
I	0.250	0.355	0.010	0.014
J	10°	16°	10°	16°
K	1.550	1.800	0.061	0.071