

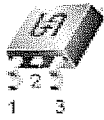

TSM2N60

N-Channel Power Enhancement Mode MOSFET

TO-252



TO-251

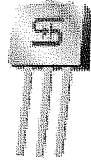

Pin assignment:

1. Gate
2. Source
3. Drain

$V_{DS} = 600V$

$I_D = 2A$

$R_{DS(on)}, V_{GS} @ 10V, I_{DS} @ 1.0A = 4.4\Omega$

General Description

The TSM2N60 is used an advanced termination scheme to provide enhanced voltage-blocking capability without degrading performance over time. In addition, this advanced MOSFET is designed to withstand high energy in avalanche and commutation modes. The new energy efficient design also offers a drain- to-source diode with a fast recovery time. Designed for high voltage, high speed switching applications in power supplies, converters and PWM motor controls, these devices are particularly well suited for bridge circuits where diode speed and commutating safe operating areas are critical and offer additional and safety margin against unexpected voltage transients.

Features

- ◇ Robust high voltage termination
- ◇ Avalanche energy specified
- ◇ Diode is characterized for use in bridge circuits
- ◇ Source to Drain diode recovery time comparable to a discrete fast recovery diode.
- ◇ I_{DSS} and $V_{DS(on)}$ specified at elevated temperature

Block Diagram

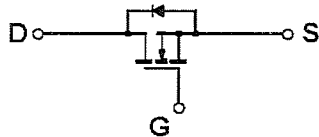

Ordering Information

Part No.	Packing	Package
TSM2N60CP	Tape & Reel	TO-252
TSM2N60CH	Tube	TO-251

Absolute Maximum Rating (Ta = 25 °C unless otherwise noted)

Parameter	Symbol	Limit	Unit
Drain-Source Voltage	V_{DS}	600V	V
Gate-Source Voltage	V_{GS}	± 20	V
Continuous Drain Current	I_D	2	A
Pulsed Drain Current	I_{DM}	9	A
Maximum Power Dissipation	P_D	Ta = 25 °C	50
		Ta > 25 °C	0.4
Operating Junction Temperature	T_J	+150	°C
Operating Junction and Storage Temperature Range	T_J, T_{STG}	- 55 to +150	°C
Single Pulse Drain to Source Avalanche Energy ($V_{DD} = 100V, V_{GS} = 10V, I_{AS} = 2A, L = 10mH, R_G = 25\Omega$)	E_{AS}	20	mJ

Thermal Performance

Parameter	Symbol	Limit	Unit
Lead Temperature (1/8" from case)	T_L	10	S
Junction to Ambient Thermal Resistance (PCB mounted)	$R_{\theta ja}$	62.5	°C/W

Note: Surface mounted on FR4 board $t \leq 10$ sec.



Electrical Characteristics						
T _j = 25 °C, unless otherwise noted						
Parameter	Conditions	Symbol	Min	Typ	Max	Unit
Static						
Drain-Source Breakdown Voltage	V _{GS} = 0V, I _D = 250uA	BV _{DSS}	600	--	--	V
Drain-Source On-State Resistance	V _{GS} = 10V, I _D = 0.6A	R _{DS(ON)}	--	--	8.0	Ω
Gate Threshold Voltage	V _{DS} = V _{GS} , I _D = 250uA	V _{GS(TH)}	2.0	--	4.0	V
Zero Gate Voltage Drain Current	V _{DS} = 600V, V _{GS} = 0V	I _{DSS}	--	--	250	uA
Gate Body Leakage	V _{GS} = ± 20V, V _{DS} = 0V	I _{GSS}	--	--	± 100	nA
Forward Transconductance	V _{DS} ≥ 50V, I _D = 1.0A	g _{fs}	1.0	--	--	S
Dynamic						
Total Gate Charge	V _{DS} = 400V, I _D = 2.0A, V _{GS} = 10V	Q _g	--	13	22	nC
Gate-Source Charge		Q _{gs}	--	2	--	
Gate-Drain Charge		Q _{gd}	--	6	--	
Turn-On Delay Time	V _{DD} = 300V, I _D = 2A, V _{GEN} = 10V, R _G = 18Ω	t _{d(on)}	--	12		nS
Turn-On Rise Time		t _r	--	21		
Turn-Off Delay Time		t _{d(off)}	--	30		
Turn-Off Fall Time		t _f	--	24		
Input Capacitance	V _{DS} = 25V, V _{GS} = 0V, f = 1.0MHz	C _{iss}	--	435	--	pF
Output Capacitance		C _{oss}	--	56	--	
Reverse Transfer Capacitance		C _{rss}	--	9.2	--	
Source-Drain Diode						
Max. Diode Forward Current		I _S	--	--	2.0	A
Diode Forward Voltage	I _S = 2.0A, V _{GS} = 0V	V _{SD}	--	--	1.6	V

Note: 1. pulse test: pulse width ≤ 300uS, duty cycle ≤ 2%
 2. Negligible, Dominated by circuit inductance.

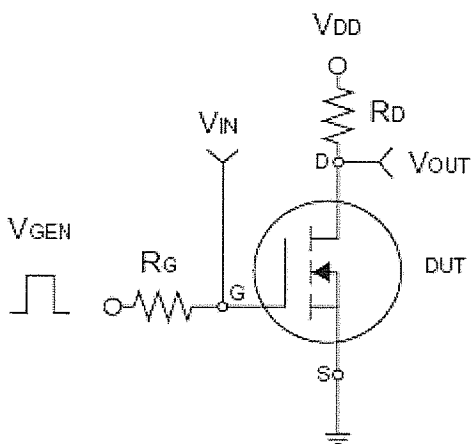

Switching Test Circuit

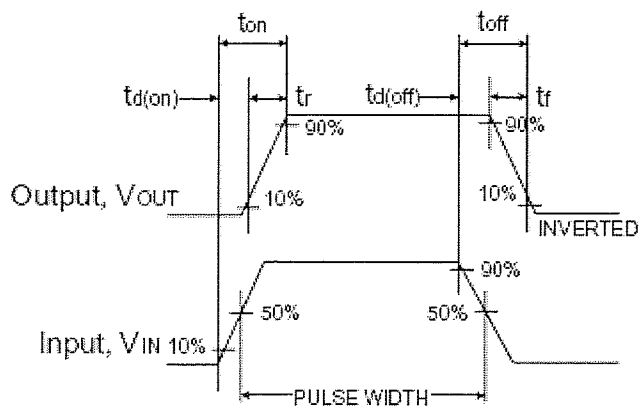

Switchin Waveforms

TO-252 Mechanical Drawing

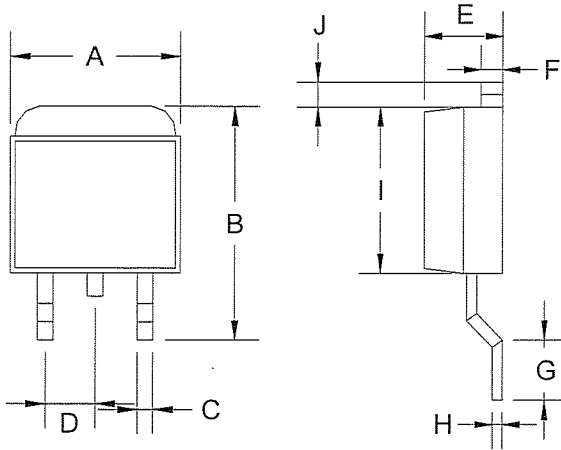

DIM	TO-252 DIMENSION			
	MILLIMETERS		INCHES	
	MIN	MAX	MIN	MAX
A	6.570	6.840	0.259	0.269
B	9.250	10.400	0.364	0.409
C	0.550	0.700	0.022	0.028
D	2.560	2.670	0.101	0.105
E	2.300	2.390	0.090	0.094
F	0.490	0.570	0.019	0.022
G	1.460	1.580	0.057	0.062
H	0.520	0.570	0.020	0.022
I	5.340	5.550	0.210	0.219
J	1.460	1.640	0.057	0.065

TO-252 Mechanical Drawing

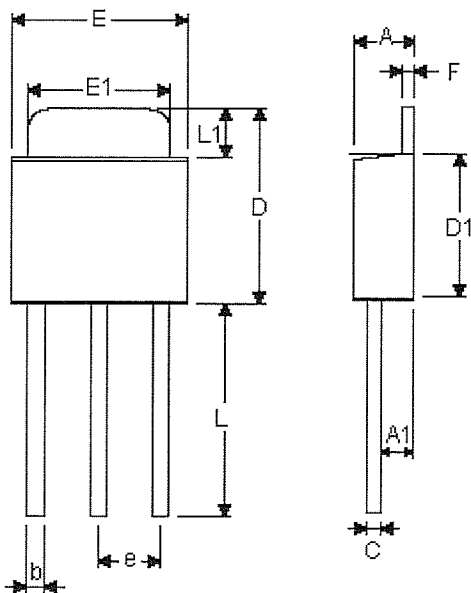

DIM	TO-252 DIMENSION			
	MILLIMETERS		INCHES	
	MIN	MAX	MIN	MAX
A	2.20	2.4	0.087	0.095
A1	1.10	1.30	0.043	0.051
b	0.40	0.80	0.016	0.032
C	0.40	0.60	0.016	0.024
D	6.70	7.30	0.264	0.287
D1	5.40	5.65	0.213	0.222
E	6.40	6.65	0.252	0.262
e	2.10	2.50	0.083	0.098
F	0.40	0.60	0.016	0.024
L	7.00	8.00	0.276	0.315
L1	1.60	1.86	0.063	0.073