



TSM2N7002E

50V N-Channel Enhancement Mode MOSFET

SOT-23**SOT-323**

Pin assignment:

1. Gate
2. Source
3. Drain

V_{DS} = 50V**R_{DS (on)}, V_{GS} @ 10V, I_{DS} @ 250mA = 3Ω****R_{DS (on)}, V_{GS} @ 5V, I_{DS} @ 50mA = 4Ω**

Features

- ◇ Advanced trench process technology
- ◇ High density cell design for ultra low on-resistance
- ◇ High input impedance
- ◇ High speed switching
- ◇ No minority carrier storage time
- ◇ CMOS logic compatible input
- ◇ No secondary breakdown
- ◇ Compact and low profile SOT-363 package

Block Diagram

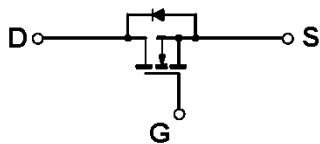

Ordering Information

Part No.	Packing	Package
TSM2N7002ECX	T & R	SOT-23
TSM2N7002ECU	(3kpcs/Reel)	SOT-323

Absolute Maximum Rating (Ta = 25°C unless otherwise noted)

Parameter	Symbol	Limit	Unit
Drain-Source Voltage	V _{DS}	50	V
Gate-Source Voltage	V _{GS}	± 20	V
Continuous Drain Current	I _D	250	mA
Pulsed Drain Current	I _{DM}	1.0	A
Maximum Power Dissipation	P _D	Ta = 25°C	200
		Ta = 75°C	150
Operating Junction Temperature	T _J	+150	°C
Operating Junction and Storage Temperature Range	T _J , T _{STG}	- 55 to +150	°C

Thermal Performance

Parameter	Symbol	Limit	Unit
Lead Temperature (1/8" from case)	T _L	5	S
Junction to Ambient Thermal Resistance (PCB mounted)	Rθja	625	°C/W

Note: Surface mounted on FR4 board t<=5sec.



Electrical Characteristics						
T _j = 25 °C unless otherwise noted						
Parameter	Conditions	Symbol	Min	Typ	Max	Unit
Static						
Drain-Source Breakdown Voltage	V _{GS} = 0V, I _D = 10uA	BV _{DSS}	50	--	--	V
Drain-Source On-State Resistance	V _{GS} = 10V, I _D = 250mA	R _{DS(ON)}	--	--	3	Ω
Drain-Source On-State Resistance	V _{GS} = 5V, I _D = 50mA	R _{DS(ON)}	--	--	4	
Gate Threshold Voltage	V _{DS} = V _{GS} , I _D = 250uA	V _{GS(TH)}	1.0	2.0	2.5	V
Zero Gate Voltage Drain Current	V _{DS} = 50V, V _{GS} = 0V	I _{DSS}	--	--	1.0	uA
Gate Body Leakage	V _{GS} = ± 20V, V _{DS} = 0V	I _{GSS}	--	--	± 100	nA
On-State Drain Current	V _{DS} ≥ 7V, V _{GS} = 10V	I _{D(ON)}	500	--	--	mA
Forward Transconductance	V _{DS} = 7V, I _D = 200mA	g _{fs}	80	--	--	mS
Dynamic *						
Turn-On Delay Time	V _{DD} = 30V, I _D = 100mA, V _{GEN} = 10V, R _G = 10Ω	T _{D(ON)}	--	7.5	20	nS
Turn-On Rise Time		t _r	--	6	--	
Turn-Off Delay Time		T _{D(OFF)}	--	7.5	20	
Turn-Off Fall Time		t _f	--	3	--	
Input Capacitance	V _{DS} = 25V, V _{GS} = 0V, f = 1.0MHz	C _{iss}	--	19	50	pF
Output Capacitance		C _{oss}	--	10	25	
Reverse Transfer Capacitance		C _{rss}	--	3	5	
Source-Drain Diode						
Max. Diode Forward Current		I _S	--	--	115	mA
Diode Forward Voltage	I _S = 115mA, V _{GS} = 0V	V _{SD}	--	0.76	1.5	V

Note : pulse test: pulse width <=300uS, duty cycle <=2%

* Guaranteed by design, not subject to production testing.

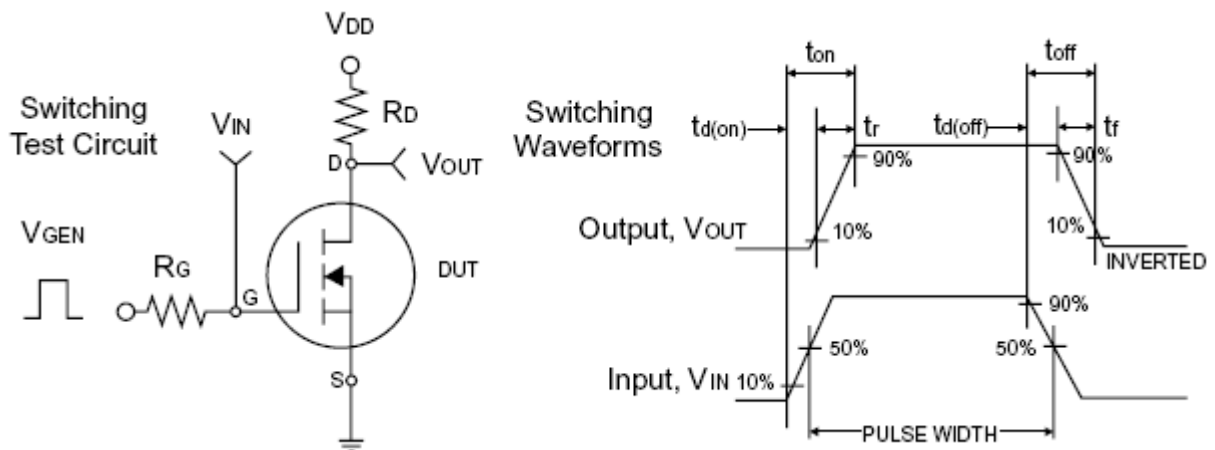



Typical Characteristics Curve ($T_a = 25^\circ\text{C}$ unless otherwise noted)

Output Characteristic

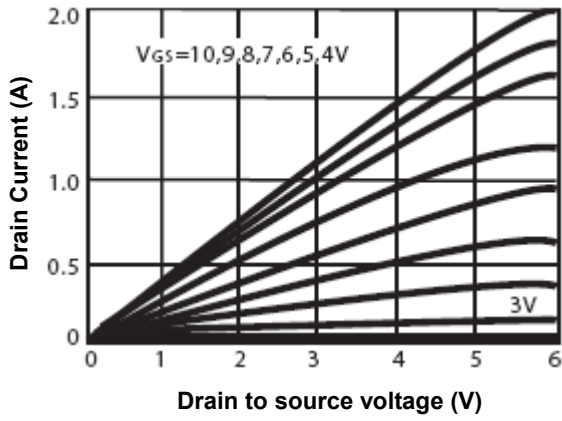

Transfer Characteristics

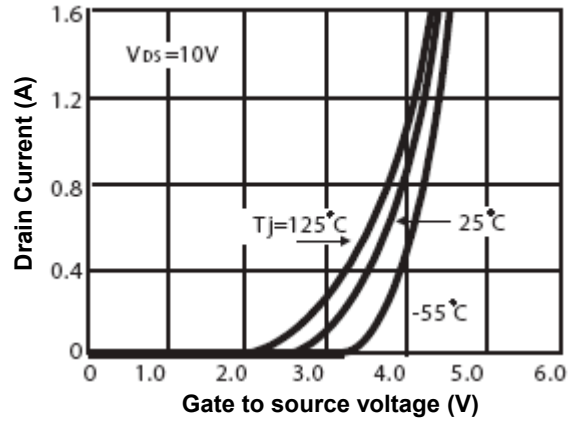

Capacitance

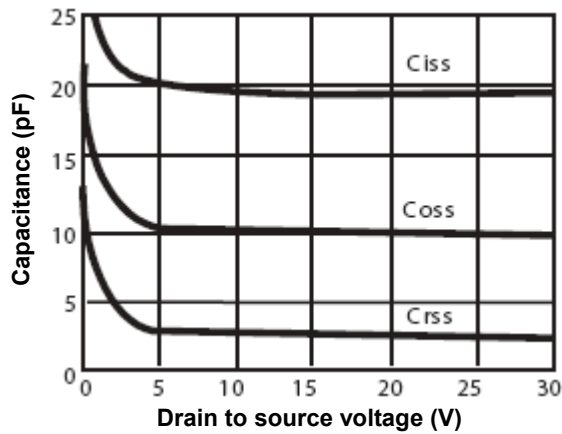

$R_{ds(on)}$ Variation with Drain Current

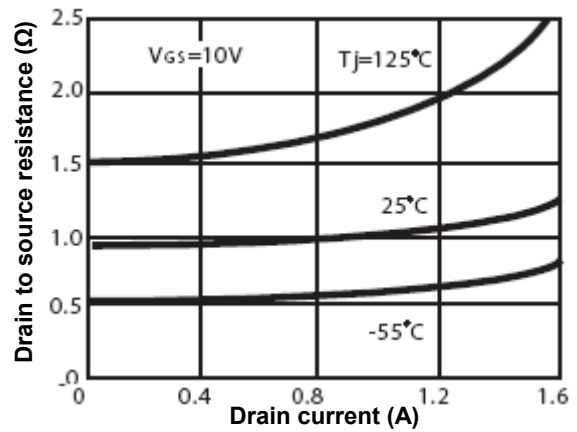

$V_{GS(th)}$ with Temperature

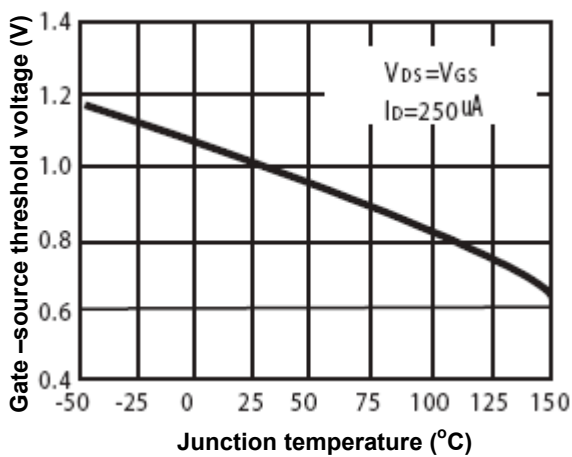

V_{DS} breakdown with Temperature

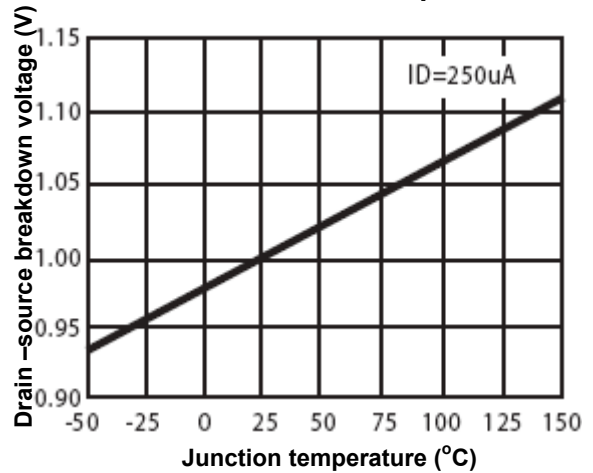



Typical Characteristics Curve ($T_a = 25^\circ\text{C}$ unless otherwise noted)

Transconductance Variation

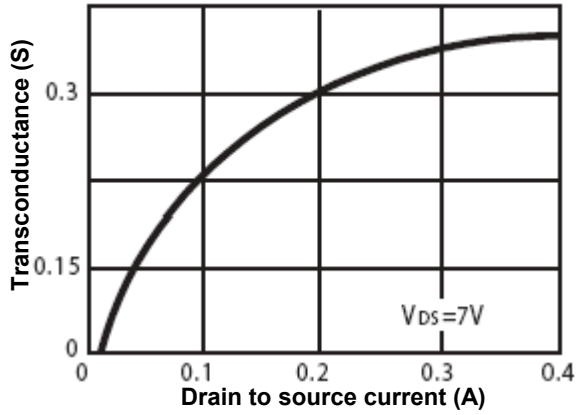

Body Diode Forward Voltage

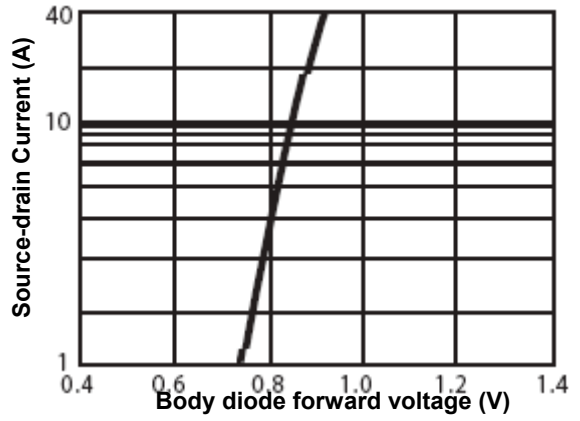

Gate Charge

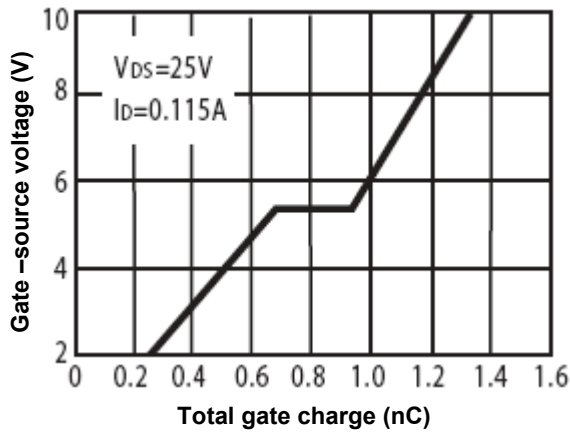

Maximum Safe Operating Area

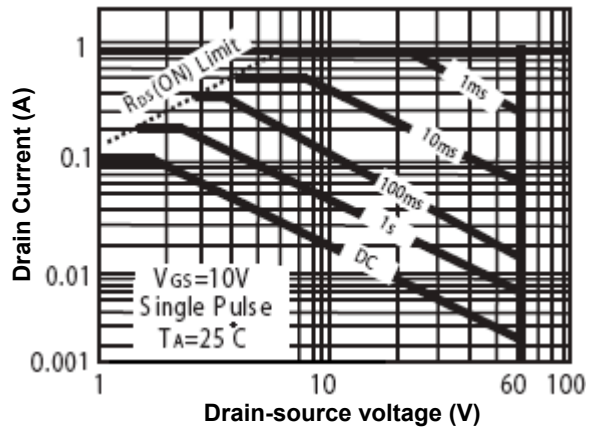

Normalized Thermal Transient Impedance Curve

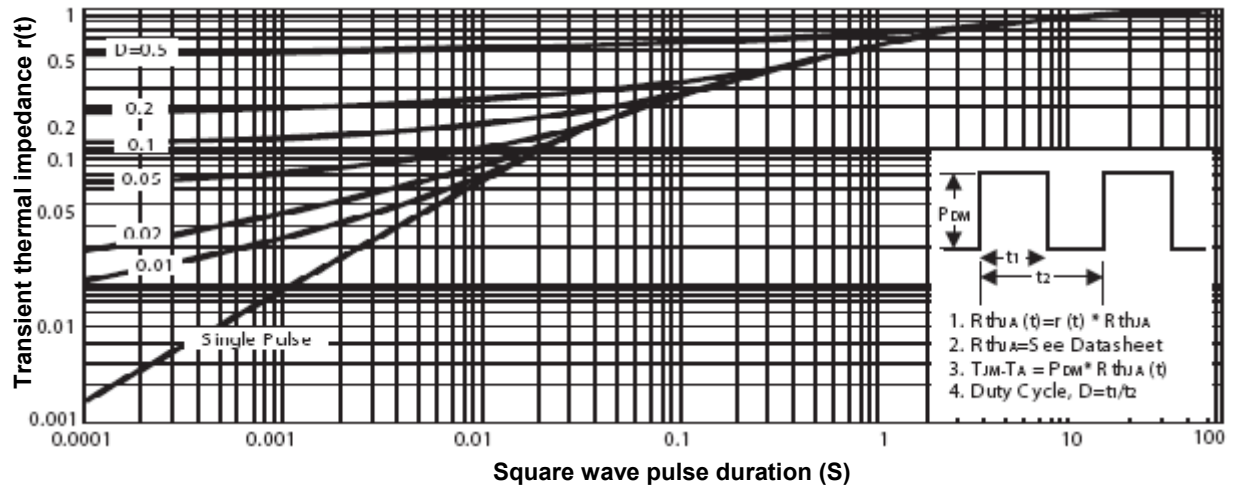

SOT-23 Mechanical Drawing

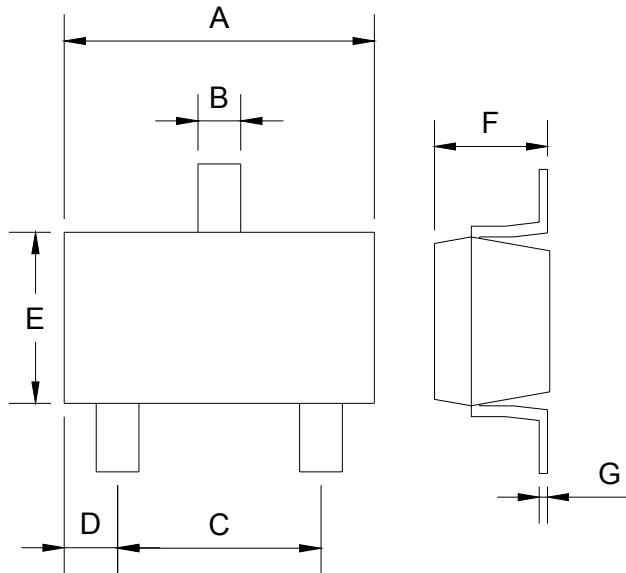

SOT-23 DIMENSION				
DIM	MILLIMETERS		INCHES	
	MIN	MAX	MIN	MAX
A	2.88	2.91	0.113	0.115
B	0.39	0.42	0.015	0.017
C	1.78	2.03	0.070	0.080
D	0.51	0.61	0.020	0.024
E	1.59	1.66	0.063	0.065
F	1.04	1.08	0.041	0.043
G	0.07	0.09	0.003	0.004

SOT-323 Mechanical Drawing

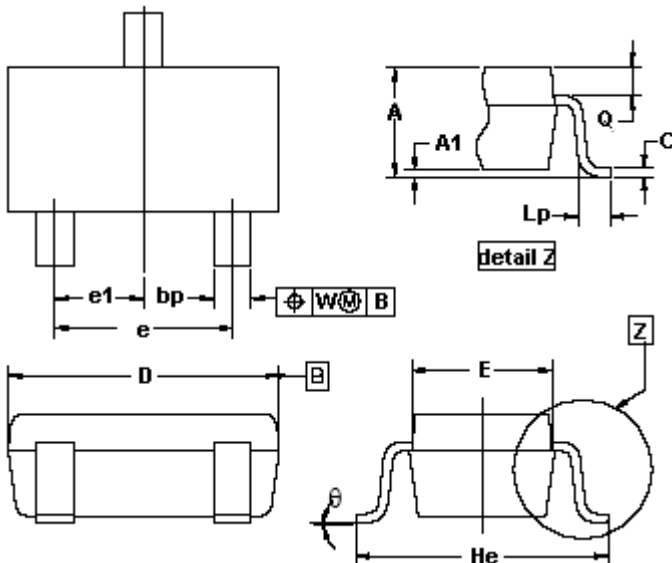

SOT-323 DIMENSION				
DIM	MILLIMETERS		INCHES	
	MIN	MAX	MIN	MAX
A	0.80	1.10	0.0315	0.0433
A1	--	0.10	--	0.0039
bp	0.30	0.40	0.0118	0.0157
C	0.10	0.25	0.0039	0.0098
D	1.80	2.20	0.0709	0.0866
E	1.15	1.35	0.0453	0.0531
e	1.30	--	0.0512	--
e1	0.65	--	0.0256	--
He	2.00	2.20	0.0787	0.0866
Lp	0.15	0.45	0.0059	0.0177
Q	0.13	0.23	0.0051	0.0091
W	0.20	--	0.0079	--
theta	10°	--	10°	--