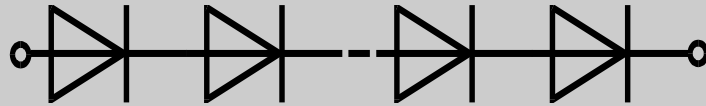


# High Voltage rectifiers Hochspannungs- gleichrichter

Edition 97



Reg. Nr. 2743-02

 IXYS

## Symbols and Definitions

<b>a</b>	Acceleration
$I_{F(AV)M}$	Maximum mean forward current
$I_{F(RMS)}$	Maximum RMS forward current
$I_{FSM}$	Surge forward current
$I_R$	Repetitive peak reverse current
<b>M<sub>d</sub></b>	Mounting torque
<b>P<sub>RSM</sub></b>	Maximum surge reverse power dissipation
$r_T$	Forward slope resistance (for power loss calculations only)
<b>T<sub>amb</sub></b>	Ambient temperature or temperature of the cooling medium
<b>T<sub>stg</sub></b>	Storage temperature
<b>T<sub>(vj)</sub></b>	Virtual junction temperature
$V_{dT}$	DC voltage at $V_{V(RMS)}$ arithmetic mean
$V_F$	Forward voltage
$V_{RRM}$	Maximum repetitive peak reverse voltage
$V_{V(RMS)}$	Supply voltage, RMS value
$V_{TO}$	Threshold voltage (for power loss calculations only)

## Kurzzeichen und Begriffe

<b>a</b>	Rüttelfestigkeit
$I_{F(AV)M}$	Maximaler Durchlaßstrom-Mittelwert
$I_{F(RMS)}$	Höchstzulässiger Effektiv-Durchlaßstrom
$I_{FSM}$	Maximaler Stoßstrom
$I_R$	Sperrstrom
<b>M<sub>d</sub></b>	Anzugsdrehmoment
<b>P<sub>RSM</sub></b>	Maximale Stoßsperrverlustleistung
$r_T$	Ersatzwiderstand (nur zur Berechnung der Verlustleistung)
<b>T<sub>amb</sub></b>	Umgebungstemperatur oder Kühlmitteltemperatur
<b>T<sub>stg</sub></b>	Lagertemperatur
<b>T<sub>(vj)</sub></b>	Sperrschichttemperatur
$V_{dT}$	Typgleichspannung bei $V_{V(RMS)}$ arithm. Mittelwert
$V_F$	Durchlaßspannung
$V_{RRM}$	Höchstzul. periodische Spitzensperrspannung
$V_{V(RMS)}$	Typische Anschlußspannung (Effektivwert)
$V_{TO}$	Schleusenspannung (nur zur Berechnung der Verlustleistung)

## Nomenclature for High Voltage Rectifiers

Example: UGE 0421 AY4

<b>U</b>	High Voltage rectifier, U-Series
<b>G</b>	Uncontrolled rectifier
<b>E</b>	One way circuit
<b>B</b>	One phase bridge circuit
<b>D</b>	Three phase bridge circuit
	Code, number of power semiconductors
<b>0</b>	1- 4
<b>1</b>	5- 6
<b>2</b>	7-12
<b>4</b>	Code, max. average forward current in A $1 \leq 3 \text{ A}$ ; $2 \leq 12 \text{ A}$ ; $3 \leq 16 \text{ A}$ ; $4 \leq 33 \text{ A}$ etc.
<b>2</b>	Code, type of built in power semiconductors
<b>1</b>	Code, max. RMS voltage $1 \geq 1 \text{ KV}$ ; $2 \geq 2 \text{ KV}$ ; $3 \geq 3 \text{ KV}$ etc.
<b>A</b>	Letter, A = avalanche diode
<b>Y4</b>	Version (see dimension drawing) Y4 = round housing, A-N = plastic housing

Beispiel: UGE 0421 AY4

<b>U</b>	Hochspannungs-Gleichrichter, Baureihe U
<b>G</b>	Ungesteuerter Gleichrichter
<b>E</b>	Einwegschaltung
<b>B</b>	Einphasen-Brückenschaltung
<b>D</b>	Dreiphasen-Brückenschaltung
	Kennziffer, Anzahl der Leistungshalbleiter
<b>0</b>	1- 4
<b>1</b>	5- 6
<b>2</b>	7-12
<b>4</b>	Kennziffer, Dauergrenzstrom in A $1 \leq 3 \text{ A}$ ; $2 \leq 12 \text{ A}$ ; $3 \leq 16 \text{ A}$ ; $4 \leq 33 \text{ A}$ usw.
<b>2</b>	Kennziffer, Art der eingebauten Dioden
<b>1</b>	Kennziffer, Anschlußspannung $1 \geq 1 \text{ KV}$ ; $2 \geq 2 \text{ KV}$ ; $3 \geq 3 \text{ KV}$ usw.
<b>A</b>	Buchstabe, A = Avalanche-Diode
<b>Y4</b>	Gehäusebauform (siehe Maßbild) Y4 = runder Becher, A-N = Kunststoff- becher

# Contents/Inhalt

Page  
Seite

Symbols and Definitions / Kurzzeichen und Begriffe

2

Circuit configuration Schaltbild	Type Typ	$V_{RRM}$  V	$V_{V(RMS)}$  V	$I_{F(AV)M}$  A	$I_{FSM}$ 45°C 10 ms A	
	<b>UGB 3132 AD</b>	4800	2250	1.3	60	3
	<b>UGB 6124 AG</b>	10500	5000	1.0	50	3
	<b>UGD 6123 AG</b>	7200	3300	1.8	50	3
	<b>UGD 8124 AG</b>	10500	5000	1.2	50	3
	<b>UGE 0421 AY4</b>	3200	1125	23/7.4	300	4 - 5
	<b>UGE 0221 AY4</b>	4800	1750	10/3.8	180	6 - 7
	<b>UGE 1112 AY4</b>	8000	3000	4.2/2.0	120	8 - 9
	<b>UGE 3126 AY4</b>	24000	9000	2.0/0.8	70	10 - 11

Technical data, application notes / Technische Daten, Applikationshinweise

12 - 13

Mounting instructions / Montagehinweise

15 - 15

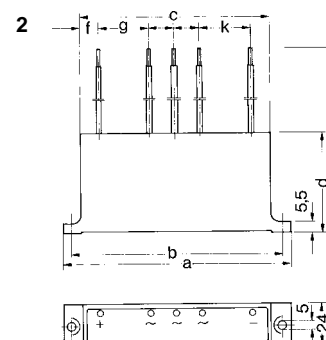
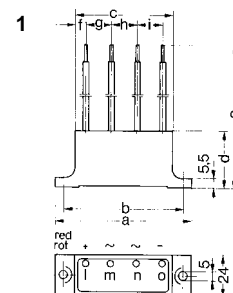
IXYS International Sales Representatives

16

## 1~ / 3~ High Voltage Rectifier Modules Hochspannungs-Gleichrichter-Module

Typ	$V_{RRM}$  V	$V_{V(RMS)}$  V	$I_{F(AV)M}$  A	$I_{FSM}$ 45°C 10 ms A	$T_{(vj)m}$  °C	Weight Gewicht	Dimensions Maßbild
<b>UGB 3132 AD</b>	4800	2250	1.3	60	150	150	1
<b>UGB 6124 AG</b>	10500	5000	1.0	50	150	300	1
<b>UGD 6123 AG</b>	7200	3300	1.8	50	150	300	2
<b>UGD 8124 AG</b>	10500	5000	1.2	50	150	300	2

Typ	a	b	c	d	e	f	g	h	i	k
<b>UGB 3132 AD</b>	80	70	57	58.5	260	6	15	15	15	
<b>UGB 6124 AG</b>	135	125	112	58.5	260	11	32.5	25	32.5	
<b>UGB 6123 AG</b>	135	125	112	58.5	260	8	30	18	18	30
<b>UGB 8124 AG</b>	135	125	112	58.5	260	8	30	18	18	30



# High Voltage Rectifiers

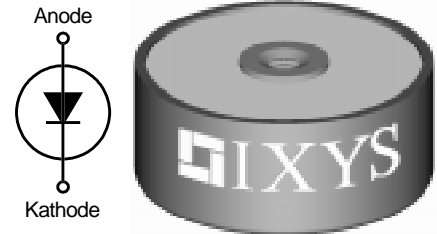
## Hochspannungsgleichrichter

$$V_{RRM} = 3200 \text{ V}$$

$$V_{dT} = 500 \text{ V}$$

$$I_{F(AV)M} = 22.9 \text{ A}$$

$V_{RRM}$ V	$V_{V(RMS)}$ V	$V_{dT}$ V	Standard Types	Power Designation
3200	1125	500	UGE 0421 AY4	Si-E 1125 / 500-6



Symbol	Test Conditions	Ratings
$I_{F(RMS)}$ $I_{F(AV)M}$	air self cooling, $T_{amb} = 45^\circ\text{C}$	40 A
	- without cooling plate	7.4 A
	- with colling plate	10.9 A
	forced air cooling: $v = 3 \text{ m/s}$ , $T_{amb} = 35^\circ\text{C}$	
	- without cooling plate	14.2 A
	- with cooling plate	18.8 A
	oil cooling, $T_{amb} = 35^\circ\text{C}$	
	- without cooling plate	19.7 A
	- with cooling plate	22.9 A
$P_{RSM}$	$T_{(vj)} = 150^\circ\text{C}$ ; $t_p = 10 \mu\text{s}$	7 kW
$I_{FSM}$	non repetitive, 50 c/s (for 60 c/s add 10%) $T_{(vj)} = 45^\circ\text{C}$ ; $t_p = 10 \text{ ms}$	300 A
	$T_{(vj)} = 150^\circ\text{C}$ ; $t_p = 10 \text{ ms}$	250 A
$T_{amb}$		-40...+150 °C
$T_{stg}$		-40...+150 °C
$T_{(vj)}$		150 °C

**Weight** 115 g

Symbol	Test Conditions	Characteristic Values
$I_R$	$T_{(vj)} = 150^\circ\text{C}$ ; $V_R = V_{RRM}$	$\leq 2 \text{ mA}$
$V_F$	$I_F = 55 \text{ A}$ $T_{(vj)} = 25^\circ\text{C}$	2.72 V
$V_{TO}$	$T_{(vj)} = 150^\circ\text{C}$	1.7 V
$r_T$	$T_{(vj)} = 150^\circ\text{C}$	16 mΩ
<b>a</b>	$f = 50\text{Hz}$	5 x 9,81 m/s <sup>2</sup>
$M_d$		8 Nm

### Features

- Hermetically sealed Epoxy
- Use in oil
- Avalanche characteristics

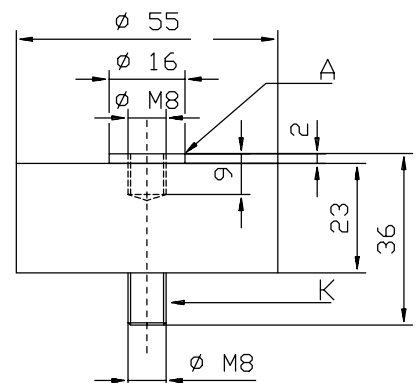
### Applications

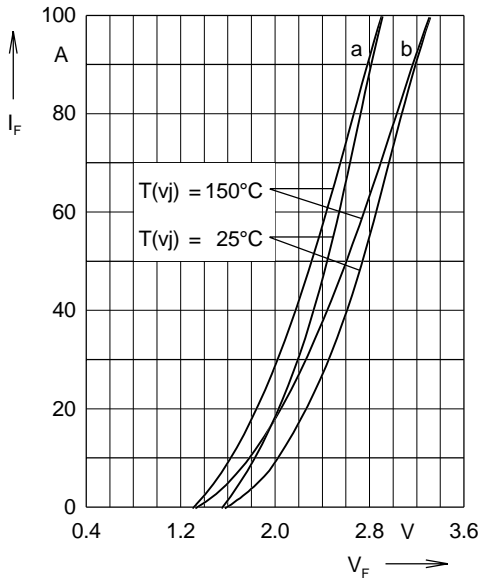
- X-Ray equipment
- Electrostatic dust precipitators
- Electronic beam welding
- Lasers
- Cable test equipment

### Advantages

- Simple mounting
- Improved temperature and power cycling
- Reduced protection circuits
- Series and parallel operation

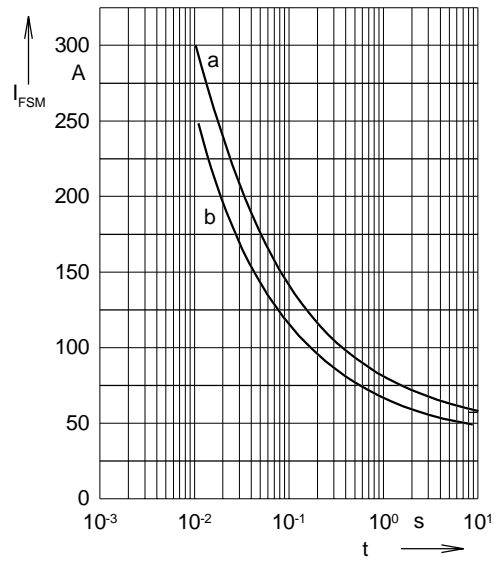
### Dimensions in mm (1 mm = 0.0394")





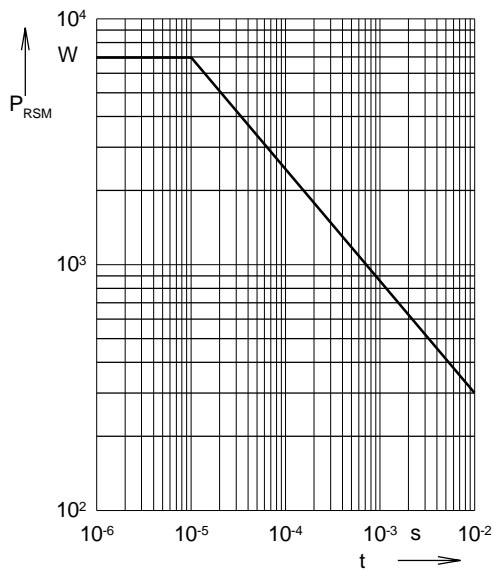
**Fig. 1: Forward characteristics**

Instantaneous forward current  $I_F$  as a function of instantaneous forward voltage drop  $V_F$  for junction temperature  $T_{(vj)} = 25^\circ\text{C}$  and  $T_{(vj)} = 150^\circ\text{C}$   
 a = Mean value characteristic  
 b = Limit value characteristic



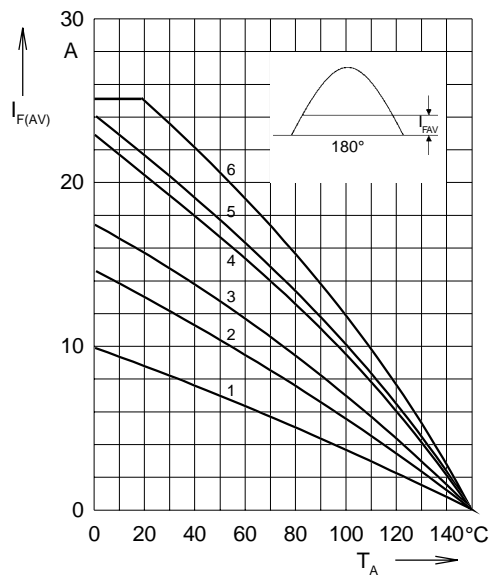
**Fig. 2: Characteristics of maximum permissible current**

The curves show the non repetitive peak one cycle surge forward current  $I_{FSM}$  as a function of time  $t$  and serve for rating protective devices.  
 a = Initial state  $T_{(vj)} = 45^\circ\text{C}$   
 b = Initial state  $T_{(vj)} = 150^\circ\text{C}$



**Fig. 3: Power loss**

Non repetitive peak reverse power loss  $P_{RSM}$  as a function of time  $t$ ,  $T_{(vj)} = 150^\circ\text{C}$



**Fig. 4: Load diagramm**

Mean forward current  $I_{F(AV)}$  of one module for a sine half wave for various cooling modes as a function of the cooling medium temperature  $T_{amb}$  for a resistive load (horizontal mounting).

**Cooling modes**

- 1 = air self cooling            without cooling plate
- 2 = air self cooling            with cooling plate
- 3 = forced air cooling        without cooling plate
- 4 = forced air cooling        with cooling plate
- 5 = oil cooling                without cooling plate
- 6 = oil cooling                with cooling plate

# High Voltage Rectifiers

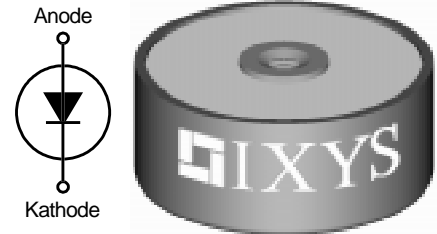
## Hochspannungsgleichrichter

$$V_{RRM} = 4800 \text{ V}$$

$$V_{dT} = 775 \text{ V}$$

$$I_{F(AV)M} = 10.2 \text{ A}$$

$V_{RRM}$ V	$V_{V(RMS)}$ V	$V_{dT}$ V	Standard Types	Power Designation
4800	1750	775	UGE 0221 AY4	Si-E 1750 / 775-4



Symbol	Test Conditions	Ratings	
$I_{F(RMS)}$ $I_{F(AV)M}$	air self cooling, $T_{amb} = 45^\circ\text{C}$	- without cooling plate	3.8 A
		- with colling plate	5.4 A
	forced air cooling: $v = 3 \text{ m/s}$ , $T_{amb} = 35^\circ\text{C}$	- without cooling plate	7.0 A
		- with cooling plate	10.2 A
oil cooling, $T_{amb} = 35^\circ\text{C}$	- without cooling plate	10.2 A	
	- with cooling plate	10.2 A	
$P_{RSM}$	$T_{(vj)} = 150^\circ\text{C}$ ; $t_p = 10 \mu\text{s}$	3.4	kW
$I_{FSM}$	non repetitive, 50 c/s (for 60 c/s add 10%) $T_{(vj)} = 45^\circ\text{C}$ ; $t_p = 10 \text{ ms}$	180	A
	$T_{(vj)} = 150^\circ\text{C}$ ; $t_p = 10 \text{ ms}$	140	A
$T_{amb}$		-40...+150	$^\circ\text{C}$
$T_{stg}$		-40...+150	$^\circ\text{C}$
$T_{(vj)}$		150	$^\circ\text{C}$

### Features

- Hermetically sealed Epoxy
- Use in oil
- Avalanche characteristics

### Applications

- X-Ray equipment
- Electrostatic dust precipitators
- Electronic beam welding
- Lasers
- Cable test equipment

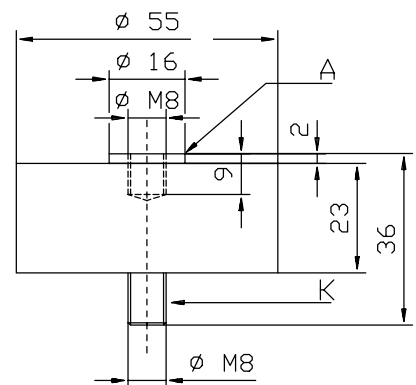
### Advantages

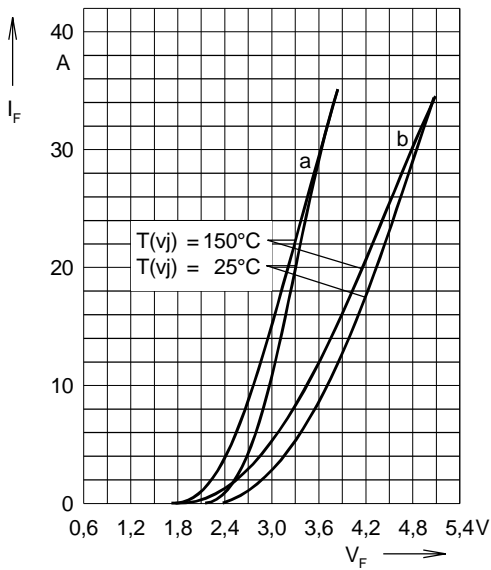
- Simple mounting
- Improved temperature and power cycling
- Reduced protection circuits
- Series and parallel operation

**Weight** 120 g

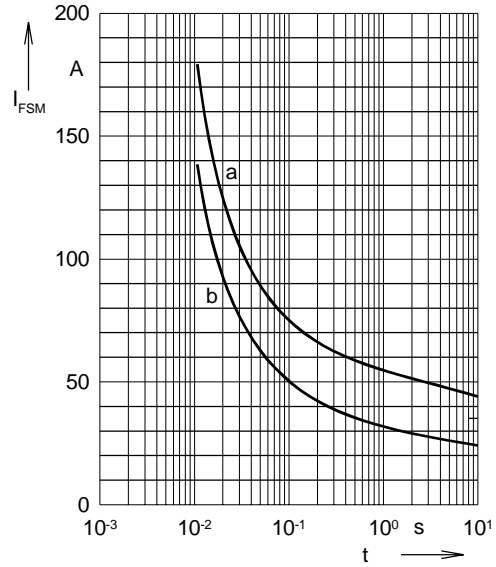
Symbol	Test Conditions	Characteristic Values	
$I_R$	$T_{(vj)} = 150^\circ\text{C}$ ; $V_R = V_{RRM}$	$\leq 2$	mA
$V_F$	$I_F = 30 \text{ A}$ $T_{(vj)} = 25^\circ\text{C}$	4.8	V
$V_{TO}$	$T_{(vj)} = 150^\circ\text{C}$	2.55	V
$r_T$	$T_{(vj)} = 150^\circ\text{C}$	90	m $\Omega$
<b>a</b>	<b>f = 50Hz</b>	5 x 9,81	m/s <sup>2</sup>
<b>M<sub>d</sub></b>		8	Nm

### Dimensions in mm (1 mm = 0.0394")

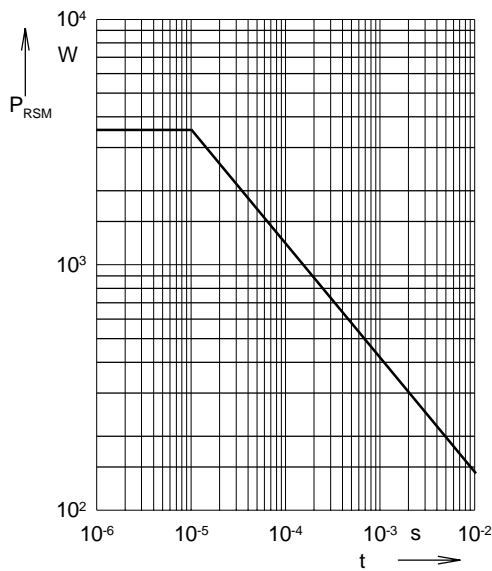




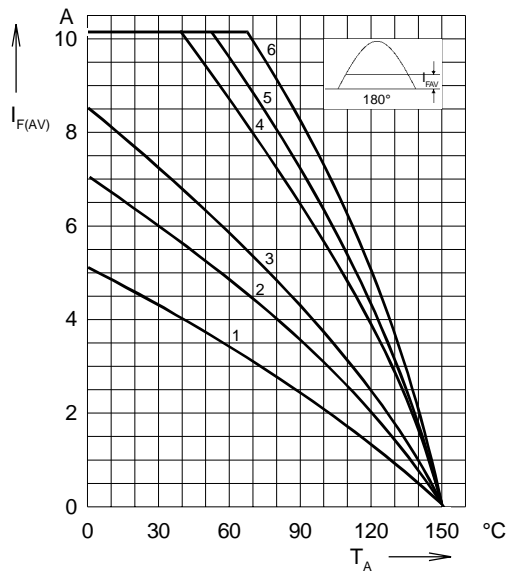
**Fig. 1: Forward characteristics**  
 Instantaneous forward current  $I_F$  as a function of instantaneous forward voltage drop  $V_F$  for junction temperature  $T_{(vj)} = 25^\circ\text{C}$  and  $T_{(vj)} = 150^\circ\text{C}$   
 a = Mean value characteristic  
 b = Limit value characteristic



**Fig. 2: Characteristics of maximum permissible current**  
 The curves show the non repetitive peak one cycle surge forward current  $I_{FSM}$  as a function of time  $t$  and serve for rating protective devices.  
 a = Initial state  $T_{(vj)} = 45^\circ\text{C}$   
 b = Initial state  $T_{(vj)} = 150^\circ\text{C}$



**Fig. 3: Power loss**  
 Non repetitive peak reverse power loss  $P_{RSM}$  as a function of time  $t$ ,  $T_{(vj)} = 150^\circ\text{C}$



**Fig. 4: Load diagramm**  
 Mean forward current  $I_{F(AV)}$  of one module for a sine half wave for various cooling modes as a function of the cooling medium temperature  $T_{amb}$  for a resistive load (horizontal mounting).

**Cooling modes**

- 1 = air self cooling            without cooling plate
- 2 = air self cooling            with cooling plate
- 3 = forced air cooling        without cooling plate
- 4 = forced air cooling        with cooling plate
- 5 = oil cooling                without cooling plate
- 6 = oil cooling                with cooling plate

# High Voltage Rectifiers

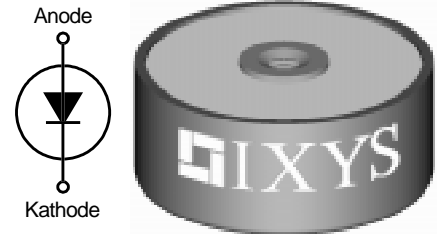
## Hochspannungsgleichrichter

$$V_{RRM} = 8000 \text{ V}$$

$$V_{dT} = 1300 \text{ V}$$

$$I_{F(AV)M} = 4.2 \text{ A}$$

$V_{RRM}$ V	$V_{V(RMS)}$ V	$V_{dT}$ V	Standard Types	Power Designation
8000	3000	1300	UGE 1112 AY4	Si-E 3000 / 1300-2.5



Symbol	Test Conditions	Ratings	
$I_{F(RMS)}$ $I_{F(AV)M}$	air self cooling, $T_{amb} = 45^\circ\text{C}$	- without cooling plate	7 A
		- with colling plate	2.0 A
	forced air cooling: $v = 3 \text{ m/s}$ , $T_{amb} = 35^\circ\text{C}$	- without cooling plate	2.5 A
		- with cooling plate	3.2 A
oil cooling, $T_{amb} = 35^\circ\text{C}$	- without cooling plate	4.1 A	
	- with cooling plate	4.2 A	
$P_{RSM}$	$T_{(vj)} = 150^\circ\text{C}$ ; $t_p = 10 \mu\text{s}$	2.5	kW
$I_{FSM}$	non repetitive, 50 c/s (for 60 c/s add 10%) $T_{(vj)} = 45^\circ\text{C}$ ; $t_p = 10 \text{ ms}$	120	A
	$T_{(vj)} = 150^\circ\text{C}$ ; $t_p = 10 \text{ ms}$	100	A
$T_{amb}$		-40...+150	$^\circ\text{C}$
$T_{stg}$		-40...+150	$^\circ\text{C}$
$T_{(vj)}$		150	$^\circ\text{C}$

### Features

- Hermetically sealed Epoxy
- Use in oil
- Avalanche characteristics

### Applications

- X-Ray equipment
- Electrostatic dust precipitators
- Electronic beam welding
- Lasers
- Cable test equipment

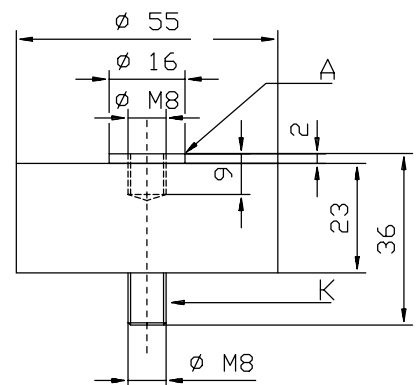
### Advantages

- Simple mounting
- Improved temperature and power cycling
- Reduced protection circuits
- Series and parallel operation

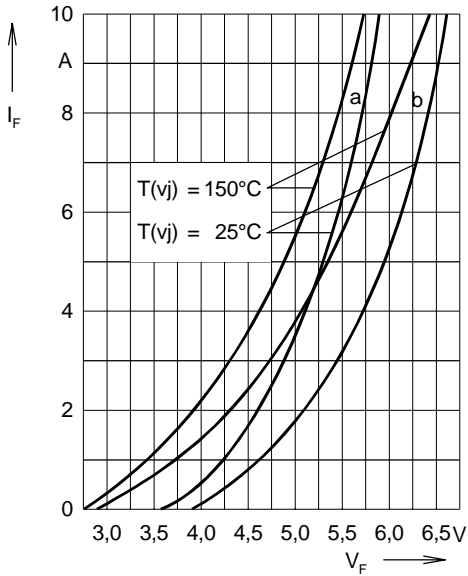
**Weight** 122 g

Symbol	Test Conditions	Characteristic Values	
$I_R$	$T_{(vj)} = 150^\circ\text{C}$ ; $V_R = V_{RRM}$	$\leq 1$	mA
$V_F$	$I_F = 7 \text{ A}$ $T_{(vj)} = 25^\circ\text{C}$	6.25	V
$V_{TO}$	$T_{(vj)} = 150^\circ\text{C}$	4.25	V
$r_T$	$T_{(vj)} = 150^\circ\text{C}$	0.215	m $\Omega$
<b>a</b>	<b>f = 50Hz</b>	5 x 9,81	m/s <sup>2</sup>
<b>M<sub>d</sub></b>		8	Nm

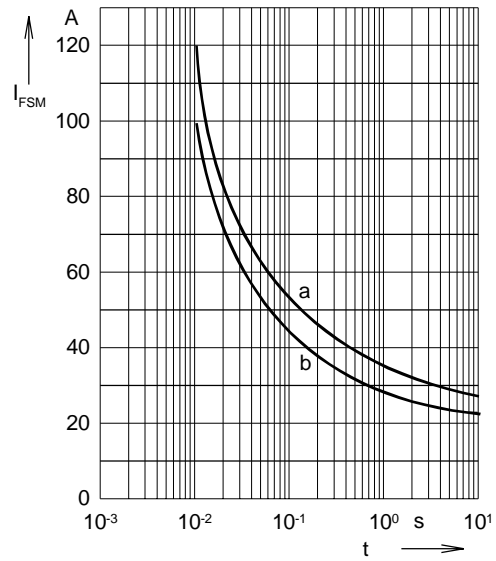
### Dimensions in mm (1 mm = 0.0394")



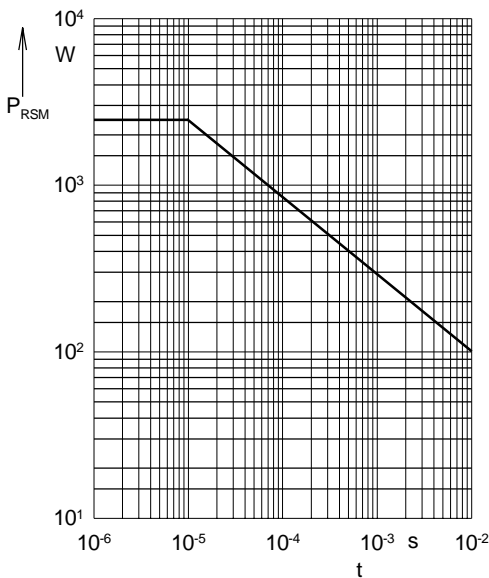




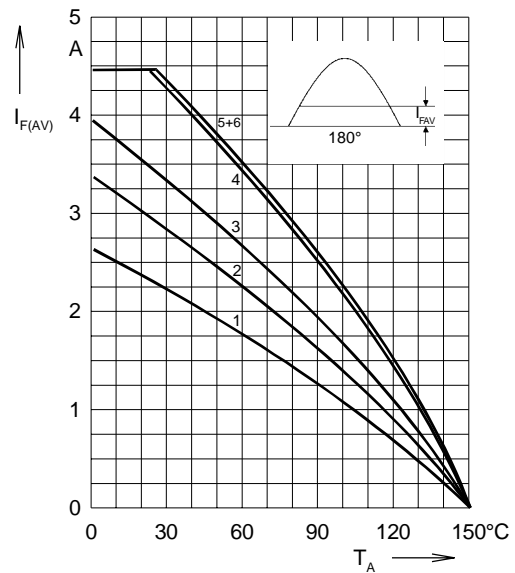
**Fig. 1: Forward characteristics**  
 Instantaneous forward current  $I_F$  as a function of instantaneous forward voltage drop  $V_F$  for junction temperature  $T_{(vj)} = 25^\circ\text{C}$  and  $T_{(vj)} = 150^\circ\text{C}$   
 a = Mean value characteristic  
 b = Limit value characteristic



**Fig. 2: Characteristics of maximum permissible current**  
 The curves show the non repetitive peak one cycle surge forward current  $I_{FSM}$  as a function of time  $t$  and serve for rating protective devices.  
 a = Initial state  $T_{(vj)} = 45^\circ\text{C}$   
 b = Initial state  $T_{(vj)} = 150^\circ\text{C}$



**Fig. 3: Power loss**  
 Non repetitive peak reverse power loss  $P_{RSM}$  as a function of time  $t$ ,  $T_{(vj)} = 150^\circ\text{C}$



**Fig. 4: Load diagramm**  
 Mean forward current  $I_{F(AV)}$  of one module for a sine half wave for various cooling modes as a function of the cooling medium temperature  $T_{amb}$  for a resistive load (horizontal mounting).

**Cooling modes**

- 1 = air self cooling            without cooling plate
- 2 = air self cooling            with cooling plate
- 3 = forced air cooling        without cooling plate
- 4 = forced air cooling        with cooling plate
- 5 = oil cooling                without cooling plate
- 6 = oil cooling                with cooling plate

# High Voltage Rectifiers

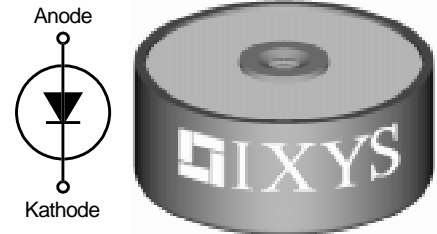
## Hochspannungsgleichrichter

$$V_{RRM} = 24000 \text{ V}$$

$$V_{dT} = 4000 \text{ V}$$

$$I_{F(AV)M} = 2.0 \text{ A}$$

$V_{RRM}$ V	$V_{V(RMS)}$ V	$V_{dT}$ V	Standard Types	Power Designation
24000	9000	4000	UGE 1112 AY4	Si-E 9000 / 4000-0.7



Symbol	Test Conditions	Ratings
$I_{F(RMS)}$ $I_{F(AV)M}$	air self cooling, $T_{amb} = 45^\circ\text{C}$	5 A
	- without cooling plate	0.8 A
	- with colling plate	1.0 A
	forced air cooling: $v = 3 \text{ m/s}$ , $T_{amb} = 35^\circ\text{C}$	
	- without cooling plate	1.4 A
	- with cooling plate	1.7 A
	oil cooling, $T_{amb} = 35^\circ\text{C}$	
	- without cooling plate	2.0 A
	- with cooling plate	2.0 A
$P_{RSM}$	$T_{(vj)} = 150^\circ\text{C}$ ; $t_p = 10 \mu\text{s}$	1.6 kW
$I_{FSM}$	non repetitive, 50 c/s (for 60 c/s add 10%) $T_{(vj)} = 45^\circ\text{C}$ ; $t_p = 10 \text{ ms}$	70 A
	$T_{(vj)} = 150^\circ\text{C}$ ; $t_p = 10 \text{ ms}$	60 A
$T_{amb}$		-40...+150 °C
$T_{stg}$		-40...+150 °C
$T_{(vj)}$		150 °C

### Features

- Hermetically sealed Epoxy
- Use in oil
- Avalanche characteristics

### Applications

- X-Ray equipment
- Electrostatic dust precipitators
- Electronic beam welding
- Lasers
- Cable test equipment

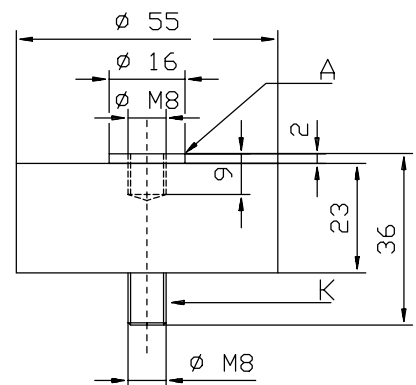
### Advantages

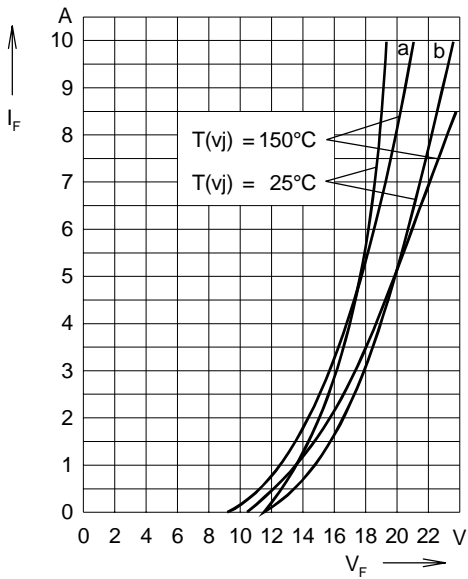
- Simple mounting
- Improved temperature and power cycling
- Reduced protection circuits
- Series and parallel operation

**Weight** 127 g

Symbol	Test Conditions	Characteristic Values
$I_R$	$T_{(vj)} = 150^\circ\text{C}$ ; $V_R = V_{RRM}$	$\leq 1 \text{ mA}$
$V_F$	$I_F = 3 \text{ A}$ $T_{(vj)} = 25^\circ\text{C}$	18 V
$V_{TO}$	$T_{(vj)} = 150^\circ\text{C}$	12 V
$r_T$	$T_{(vj)} = 150^\circ\text{C}$	1.8 mΩ
<b>a</b>	$f = 50\text{Hz}$	5 x 9,81 m/s <sup>2</sup>
$M_d$		8 Nm

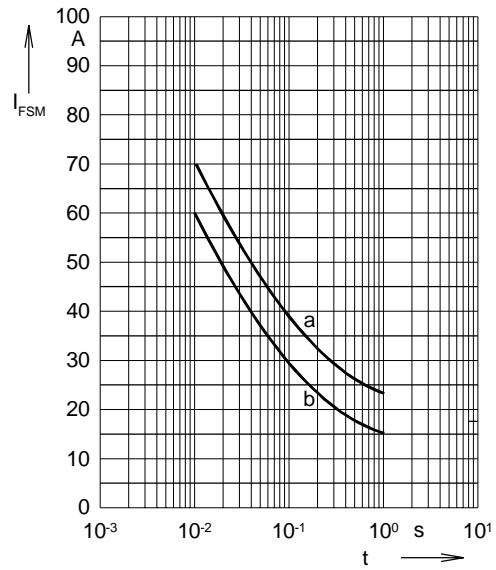
### Dimensions in mm (1 mm = 0.0394")





**Fig. 1: Forward characteristics**

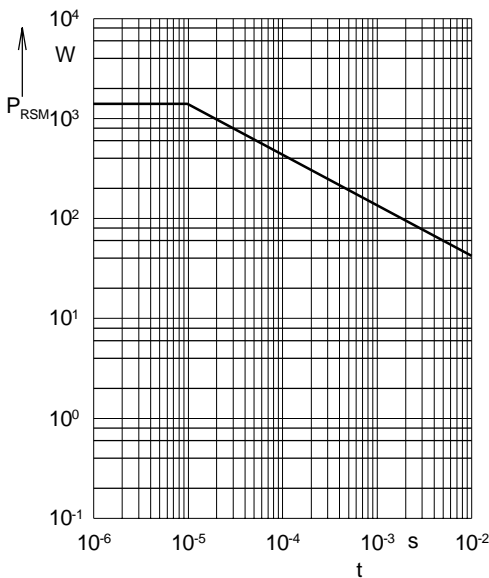
Instantaneous forward current  $I_F$  as a function of instantaneous forward voltage drop  $V_F$  for junction temperature  $T_{(vj)} = 25^\circ\text{C}$  and  $T_{(vj)} = 150^\circ\text{C}$   
 a = Mean value characteristic  
 b = Limit value characteristic



**Fig. 2: Characteristics of maximum permissible current**

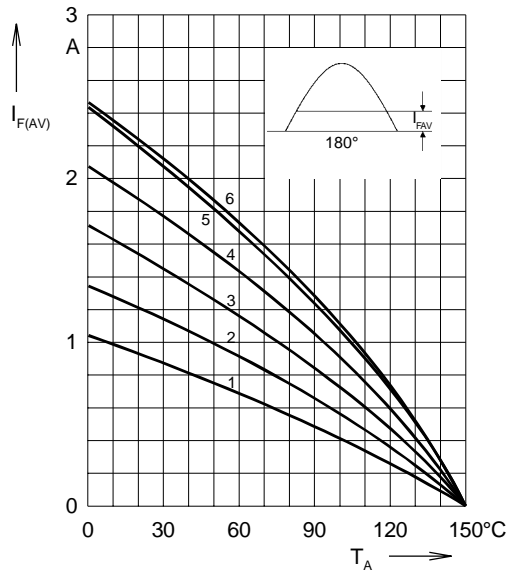
The curves show the non repetitive peak one cycle surge forward current  $I_{FSM}$  as a function of time  $t$  and serve for rating protective devices.

a = Initial state  $T_{(vj)} = 45^\circ\text{C}$   
 b = Initial state  $T_{(vj)} = 150^\circ\text{C}$



**Fig. 3: Power loss**

Non repetitive peak reverse power loss  $P_{RSM}$  as a function of time  $t$ ,  $T_{(vj)} = 150^\circ\text{C}$



**Fig. 4: Load diagramm**

Mean forward current  $I_{F(AV)}$  of one module for a sine half wave for various cooling modes as a function of the cooling medium temperature  $T_{amb}$  for a resistive load (horizontal mounting).

**Cooling modes**

- 1 = air self cooling            without cooling plate
- 2 = air self cooling            with cooling plate
- 3 = forced air cooling        without cooling plate
- 4 = forced air cooling        with cooling plate
- 5 = oil cooling                without cooling plate
- 6 = oil cooling                with cooling plate

## 1. General remarks

The high-voltage rectifier modules of the UGE series function as single-leg half-wave rectifiers (abbreviation = E). They are used for high-voltage DC supply, e.g. in

- high frequency generators
- X-ray equipment
- dust precipitators.

The construction of the module plastic case with screw connection simplifies mechanical arrangement of the desired rectifier circuit.

The user's individual input voltage and current requirements can be satisfied by selection of the appropriate modules, by mounting with or without a cooling plate or by series connection of modules.

## 2. Design

### 2.1 Electrical

High-voltage rectifier modules consist of an internally integrated series connection of avalanche diodes.

Electric terminals of the module screw connection:

- Anode (A) = Threaded hole
- Cathode (K) = Threaded bolt

### 2.2 Mechanical

(for dimensions see dimension diagram)

The avalanche diodes are embedded in an epoxy resin pot with axial metal terminals. The materials used guarantee good insulation and resistance to corrosion.

## 3. Technical data

The operating reliability of high-voltage rectifier modules is mainly influenced by the safety margin between the specified limit values and the operating data. Table on page 3 gives rated voltage values - recommended voltages with a frequency of 40 to 60 Hz and a maximum voltage variation of 10% - for the single leg circuit configuration.

When other rectifier circuits are arranged with these modules  $V_{dT}$  becomes:

- bridge circuit, B

$$V_{dT} = 0,9 \times V_{V(RMS)}$$

- three phase bridge circuit, DB

$$V_{dT} = 1,35 = V_{V(RMS)}$$

## 1. Allgemeines

Die Hochspannungsgleichrichter-Module der Serie UGE sind in ihrer elektrischen Funktion Einweggleichrichter in Einzweigschaltung (Kurzbezeichnung = E). Sie werden zur Hochspannungs-Gleichstromversorgung eingesetzt, z.B. in

- Hochfrequenz-Generatoren
- Röntgenanlagen
- elektrostatischen Staubfilteranlagen.

Die Modulkonstruktion - Kunststoffgehäuse mit Schraubverbindung - ermöglicht einen einfachen mechanischen Aufbau der gewünschten Gleichrichterschaltung.

Anwendungsspezifische Anschlußspannungen und Ströme können durch Auswahl der geeigneten Bausteine, Montage ohne und mit Kühlblech bei verschiedenen Kühlarten oder durch Serienschaltung verwirklicht werden.

## 2. Aufbau

### 2.1 Elektrisch

Hochspannungsgleichrichter-Module bestehen aus einer integrierten Reihenschaltung von Avalanche-Dioden.

Elektrische Anschlüsse der Modul-Schraubverbindung:

- Anode (A) = Gewindebohrung
- Kathode (K) = Gewindebolzen.

### 2.2 Mechanisch

(Abmessungen siehe Maßbild)

In einem Epoxydharzbecher mit axial angeordneten Metallanschlüssen sind die Avalanche-Dioden in Gießharz eingebettet. Die verwendeten Materialien garantieren eine gute Isolationsfähigkeit und Korrosionsbeständigkeit.

## 3. Technische Daten

Die Betriebszuverlässigkeit von Hochspannungsgleichrichter-Modulen wird wesentlich durch den Sicherheitsabstand zwischen den angegebenen Grenzwerten und den Einsatzdaten beeinflusst. Für die spannungsmäßige Beanspruchung in Einzweigschaltung sind in der Tabelle Seite 3 Nennwerte - das sind empfohlene Betriebsdaten, die für sinusförmige Versorgungsspannung von 40 bis 60 Hz und maximal 10% Spannungsschwankung gelten - angegeben.

Bei Aufbau von anderen Gleichrichterschaltungen mit diesen Modulen ergibt sich  $V_{dT}$  entsprechen:

- Brückenschaltung, B

$$V_{dT} = 0,9 \times V_{V(RMS)}$$

- Drehstrom-Brückenschaltung, DB

$$V_{dT} = 1,35 = V_{V(RMS)}$$

#### 4. Current reduction for series connections

When several modules are connected in series (screwed to one another), the allowed mean forward current  $I_{FAV}$  should be reduced as a function of the number of modules and cooling mode used.

##### Cooling modes

- 1 = Convection cooling without cooling plate
- 2 = Convection cooling with cooling plate
- 3 = Forced air cooling without cooling plate
- 4 = Forced air cooling with cooling plate
- 5 = Oil cooling without cooling plate
- 6 = Oil cooling with cooling plate

#### 4. Stromreduktion bei Reihenschaltung

Bei Serienschaltung (Aneinanderschrauben) mehrerer Module ist der zulässige Dauergrenzstrom  $I_{FAV}$  in Abhängigkeit von der Anzahl der Module und Kühlart zu reduzieren.

##### Definition der Kühlarten

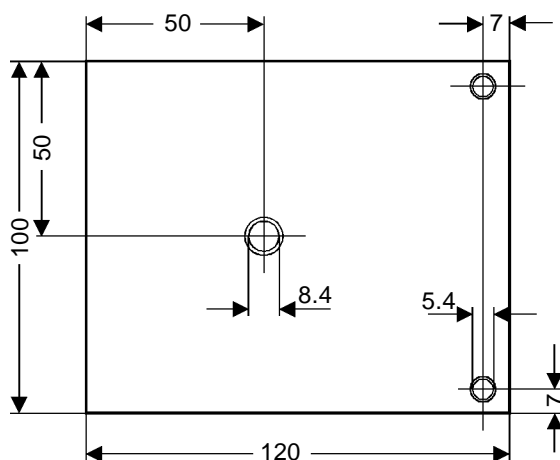
- 1 = Luftselbstkühlung ohne Kühlblech
- 2 = Luftselbstkühlung mit Kühlblech
- 3 = Verstärkte Luftkühlung ohne Kühlblech
- 4 = Verstärkte Luftkühlung mit Kühlblech
- 5 = Ölkühlung ohne Kühlblech
- 6 = Ölkühlung mit Kühlblech

Cooling mode Kühlart	Number of modules Anzahl Module					
	2	3	4	5	6	$\geq 7$
	$S_n$					
1	0,75	0,65	0,6	0,55	0,5	no further reduction keine weitere Reduktion
2	0,85	0,8	0,78	0,75		
3	0,85	0,8	0,78	0,77		
4	0,95	0,92	0,9	0,88		
5	0,92	0,88	0,86			
6	0,96	0,94				

**Table 2:** Current reduction factor  $S_n$   
**Tabelle 2:** Stromreduzierungsfaktor  $S_n$

The current reduction factors apply for air self cooling and horizontal mounting (with respect to module axis).

Die Stromreduzierungs-faktoren gelten bei Luftselbstkühlung nur für waagrechte Einbaulage (bezogen auf Modulachse).

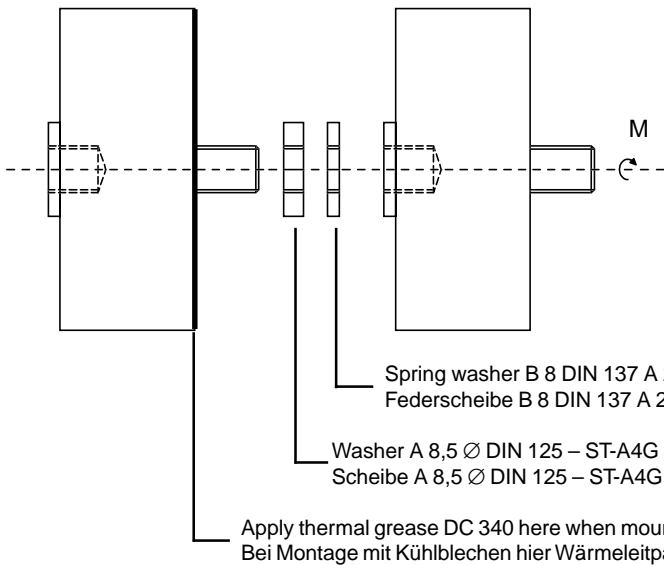


3 mm thick aluminium plate, chamfer all edges.  
 Aluminium-Blech, 3 mm dick, alle Kanten brechen.

## 5. Mounting instructions

### 5.1 Mounting of modules

without cooling plate (Fig. 7):



## 5. Montagehinweise

### 5.1 Darstellung der Montage:

Montage ohne Kühlblech (Bild 7)

**Fig. 7:** Mounting of modules  
**Bild 7:** Montage der Module

Torque M = 800 Ncm  
Drehmoment M = 800 Ncm

not included in scope of delivery  
gehört nicht zum Lieferumfang

### 5.2 Mounting of modules

with cooling plate:

as shown in Fig. 7, however, the cooling plate is mounted with thermal grease instead of with washer A 8.5 Ø DIN 125.

To satisfy VDE specification 0110, voltage limits are prescribed - depending on the creepage distance of the pot shape (61 mm for mounting without cooling plate, 42 mm for mounting with cooling plate). In case of air cooling care should be taken that the proper class of insulation is chosen for the respective supply voltage (see table 3).

### 5.2 Montage:

Module mit Kühlblech

wie in Bild 7 skizziert, jedoch anstelle der Scheibe A 8,5 Ø DIN 125 wird das Kühlblech mit Wärmeleitpaste eingesetzt.

Zur Einhaltung der VDE-Vorschrift 0110 sind - bedingt durch den Kriechweg der Bechergeometrie (61 mm bei Montage ohne Kühlblech, 42 mm bei Montage mit Kühlblech) - Spannungsgrenzen vorgeschrieben. Zu beachten ist bei Betrieb in Luft, daß sich die zulässige Anschlußspannung nach der vorgesehenen Isolationsgruppe richtet (siehe Tabelle 3).

Insulation class Isolationsgruppe	A		B		C	
	without Cooling plate ohne Kühlblech	with Cooling plate mit Kühlblech	without Cooling plate ohne Kühlblech	with Cooling plate mit Kühlblech	without Cooling plate ohne Kühlblech	with Cooling plate mit Kühlblech
Construction Aufbauart						
Allowed supply voltage based creepage distance Zulässige Anschlußspannung aufgrund des Kriechwegs	[V] 9000	[V] 7600	[V] 6900	[V] 4900	[V] 5000	[V] 3400

**Table 3**  
**Tabelle 3**

### 5.3 Distance to adjacent parts

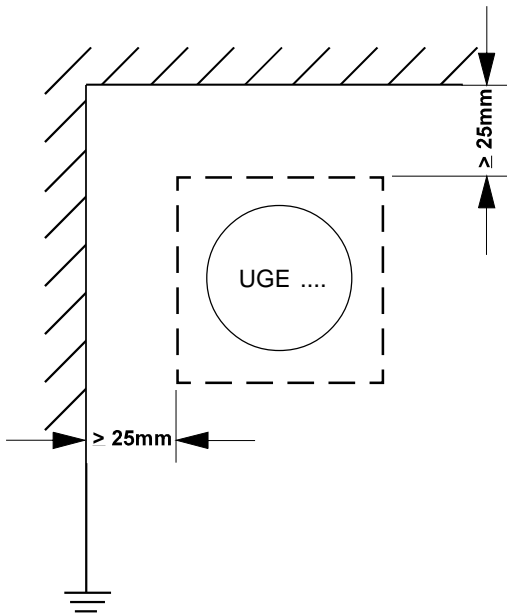
The distance to adjacent metal parts should be at least 25 mm. This also applies to mounting with cooling plates (see Fig. 8).

A protective circuit in accordance with Table 4 should be provided in order to prevent unpermissible capacitive earth currents from flowing through the first diode. This can be done by arranging the modules in groups for voltages of  $V_p \sim 30$  kV each (see Fig. 9).

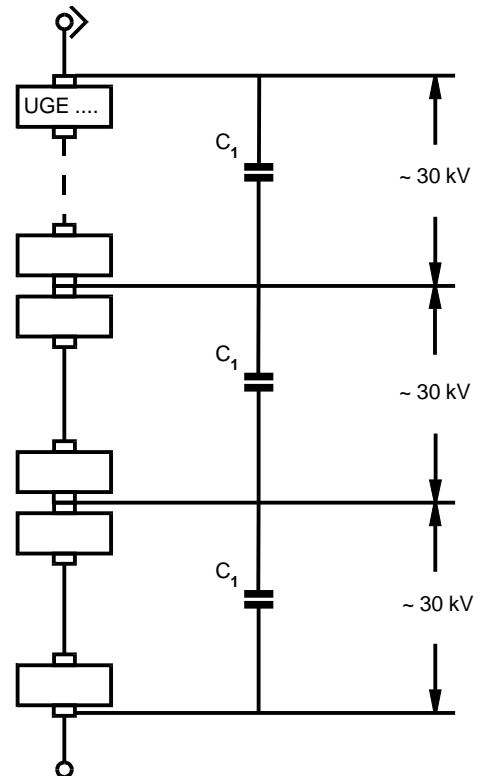
### 5.3 Abstände zur Umgebung

Der Abstand zu umgebenden geerdeten Metall-Teilen sollte minimal 25 mm betragen. Dies gilt auch bei Aufbau mit Kühlblechen (siehe Bild 8).

Zur Vermeidung von unzulässigen kapazitiven Erdströmen über die erste Diode ist eine Schutzbeschaltung nach Tabelle 4 vorzusehen. Es sind dabei jeweils Modulgruppen für Teilspannungen von  $V_p \sim 30$  kV zu bilden (siehe Bild 9).



**Fig. 8:** Minimum distance for mounting  
**Bild 8:** Mindestabstände bei Montage



**Fig. 9:** Circuit for protection of modules against capacitive earth currents  
**Bild 9:** Schutzbeschaltung der Module gegen kapazitive Erdströme

	$C_1$ (nF)
UGE 0421 AY4	5.6
UGE 0221 AY4	2.2
UGE 1112 AY4	0.87
UGE 3126 AY4	0.15

**Table 4:** Protective circuit capacitances for avoidance of too high capacitive ground currents from  $30 \text{ kV}_{\text{RMS}}$   
**Tabelle 4:** Schutzbeschaltungskapazitäten zur Vermeidung zu großer kapazitiver Erdströme ab  $30 \text{ kV}_{\text{RMS}}$

IXYS Semiconductor GmbH  
Edisonstr. 15, D-68623 Lampertheim  
Telefon: +49-6206-503-0, Fax: +49-6206-503627  
e-mail: custserv@ixys.de

IXYS Corporation  
3540 Bassett Street, Santa Clara CA 95054  
Phone: (408) 982-0700, Fax: 408-496-0670  
http://www.ixys.com  
e-mail: sales@ixys.com

Publication D 97008 DE  
Printed in Germany (09.97 • 2 • DP)

## Technical advice and further information

## IXYS International Sales Representatives

### Germany (Reps)

**North**  
Hubert Schroeter KG  
Saseler Bogen 1  
22393 Hamburg  
Phone: 040/6 00 006-0  
Fax: 040/6 00 006-30

**West**  
Erhard Mannheim KG  
Industrievertretungen  
Heidestraße 4  
42579 Heiligenhaus  
Phone: 02056/9 83 60  
Fax: 02056/5 74 37

**Southwest**  
Wolfgang Trautmann  
Reutlinger Str. 4  
78054 VS-Schwenningen  
Phone: 07720/12 03  
Fax: 07720/3 34 42

### Germany (Distris)

Kluxen GmbH  
Nordkanal 52  
20097 Hamburg 1  
Phone: 040/23 70 15 29  
Fax: 040/23 03 85

Dietrich Schuricht  
GmbH & Co. KG  
Richtweg 32  
28195 Bremen  
Phone: 0421/36 54 54  
Fax: 0421/36 54 291

BETRONIK Handelsgesellschaft  
für elektronische Bauelemente mbH  
Grünwaldstr. 39a  
12165 Berlin  
Phone: 030/79 09 97 - 0  
Fax: 030/79 09 97 51

Ingenieurbüro  
Rainer König  
Giesendorfer Str. 11 a  
12207 Berlin  
Phone: 030/76 89 09 16  
Fax: 030/76 89 09 30

MSC Vertriebs GmbH  
Industriestraße 16  
76297 Stutensee  
Phone: 07249/910-0  
Fax: 07249/79 93

Future Electronics  
Deutschland GmbH  
Münchner Straße 18  
85774 Unterföhring  
Phone: 089/95 72 70  
Fax: 089/95 72 71 29

**Sparepart-Service**  
ABB Industrietechnik AG  
Geschäftsbereich Service  
Edisonstr. 15  
68623 Lampertheim  
Phone: 06206/503 272  
Fax: 06206/503 620

IXYS Semiconductor GmbH  
Edisonstr. 15  
68623 Lampertheim  
Phone: 06206/503 394  
Fax: 06206/503 627

### Europe

**Austria**  
ABB Serienprodukte Ges.m.b.H.  
Abt. SERTQ  
Wienerbergstraße 11 B  
P.O. Box 184  
1101 Wien  
Phone: 01-60 10 9-6153  
Fax: 01-60 10 9-8600

**Denmark**  
C-88 AS  
Kokkedal Industripark 101  
2980 Kokkedal  
Phone: +45-70 10 48 88  
Fax: +45-70 10 48 89

**Finland**  
Energel Oy  
Atomitie 1  
00370 Helsinki  
Phone: 0-586 2066  
Fax: 0-586 2046

**France**  
Eurocomposant S.A.  
144 Avenue Joseph Kessel  
78960 Voisins le Bretonneux  
Phone: 1-30 64 95 15  
Fax: 1-30 43 68 27

**Greece**  
Markides Michelis & Co  
8, Markris Str., Aegaleo  
122 41 Athens  
Phone: 1-5 98 01 45  
Fax: 1-5 90 98 33

**Great Britain**  
**IXYS Semiconductor GmbH**  
Providence House  
Forest Road, Binfield  
Bracknell,  
Berkshire RG 12 5HP  
Phone: 01344-48 28 20  
Fax: 01344-48 28 10

**Great Britain**  
GD Rectifiers Ltd.  
Victoria Gardens  
Burgess Hill  
West Sussex RH159NB  
Phone: 01444-24 34 52  
Fax: 01444-87-07-22

**Great Britain**  
Larontrol Ltd.  
Unit K4 Brookside Avenue  
Rustington Trading Estate  
Littlehampton  
West Sussex BN16 3LF  
Phone: 01903-77 11 60  
Fax: 01903-77 20 73

**Great Britain**  
Future Electronics  
Poyle Road, Colnbrook  
Berkshire SL3 0EZ  
Phone: 01753-68 70 00  
Fax: 01753-68 91 00

**Italy**  
ABB DACOM SpA  
Viale Edison, 50  
20099 Sesto San Giovanni (MI)  
Phone: 02-26 232.125  
Fax: 02-26 232.144

**Netherlands**  
ABB Componenten B.V.  
Lylantse Baan 9  
2908 LG Capelle a/d IJssel  
Phone: 010-2 58 22 50  
Fax: 010-4 58 65 59

**Norway**  
Henaco A/S  
Trondheimsveien 436  
Po. box 126, Kalbakken  
0902 Oslo 9  
Phone: 2-216 21 10  
Fax: 2-225 77 80

**Sweden**  
Pelcon Electronics AB  
Girovägen 13  
Box 6023  
17562 Järfälla  
Phone: 8-7 95 98 70  
Fax: 8-7 60 76 85

**Switzerland**  
ABB Normelec AG  
Badenerstr. 790  
8048 Zürich-Altstetten  
Phone: 1-4 35 66 66  
Fax: 1-4 35 66 06

**Spain**  
ABI Semiconductores  
Dalia 387 Ch 6  
28109 El Soto (Alcobendas)  
Phone: 91-6 50 76 51  
Fax: 91-6 50 03 49

**Spain**  
AQL electrónica, s.a.  
General Palanca, 26  
28045 Madrid  
Phone: 91-4 67 75 12  
Fax: 91-5 30 29 34

**Spain**  
Rectificadores Guasch S.A.  
Componentes y Electronica de  
Potencia  
Alaba, 60-62  
08005 Barcelona  
Phone: 93-3 09 88 91  
Fax: 93-3 00 18 41

**Turkey**  
Özdisan Elektronik Pazarlama  
San. VE TIC. A.S.  
Bereketzade Mahallesi  
Galata Kulesi Sokak No: 34/3  
Karaköy/Istanbul  
Phone: 212-243 40 34, 251 29 41  
Fax: 212-244 59 43

### Asia, Australia, Africa

**Australia**  
Braemac PTY. Ltd.  
1/59-61 Burrows Road  
Alexandria NSW 2015  
Phone: (02) 9550 6600  
Fax: (02) 9550 6370

**China**  
KARIN Electronic Supplies  
Room 1095, Pana Tower  
36 Hai Dian Road  
Hai Dian District, Beijing  
Phone: 8610-6262 9049  
Fax: 8610-6264 8830

**China**  
KARIN Electronic Supplies  
Room 305, A Section,  
Yin Hai Bldg., 250 Cao Xi Rd.  
Shanghai  
Phone: 8621-6482 3543  
Fax: 8632-6482 3542

**China**  
KARIN Electronic Supplies  
Room 1503, Oriental Plaza  
39 Janshe Rd, Shenzhen  
Phone: 86755-220 9219  
Fax: 86755-228 4992

**China**  
Sunguard Electronics Ltd.  
Room 112, No. 12B  
Zhong Guan Chun Road  
Hai Dian District, Beijing  
Phone: 10-264-5210,  
10-264-5212 + 10-254-2870  
Fax: 10-254-2870

**China**  
Sunguard Electronics Ltd.  
Room 805, 8/F.,  
Sufa Building, Block 306  
ZhenHua Road, Shenzhen  
Phone: 0755-3230 748 (658)  
0755-3237 349  
Fax: 0755-3237 394

**Hongkong**  
KARIN Electronic Supplies  
Co. Ltd., Div. 8  
KARIN Building, 5F  
166 Wai Yip St., Kwun Tong  
Kowloon, Hong Kong  
Phone: 852-2763 3100  
Fax: 852-2343 6479

**Hongkong**  
Rével Electronics Co. Ltd.  
Unit 11, 12/Floor, Ricky Centre  
36 Chong Yip Street, Kwun Tong  
Kowloon, Hong Kong  
Phone: 23 89-88 91  
Fax: 23 89-24 48

**Hongkong**  
Sunguard Electronics Ltd.  
907-10 Yat Chau, International Plaza  
118 Connaught Road West  
Hong Kong  
Phone: (852) 2811 8230  
Fax: (852) 2960 1239,  
2960 1216

**India**  
Chadda Power Semiconductors  
501, Savera Apts.  
Versova Road, Andheri (West)  
Bombay-400 061  
Phone: 022-6 26 06 78  
Fax: 022-6 31 63 84

**Israel**  
Gallium Electronics Ltd.  
11 Hasadna St.  
P.O.B. 2552  
IL 43650 RA'ANANA  
Phone: 972 9 74 82 182  
Fax: 972 9 74 84 046

**Japan**  
Unidux Inc.  
5-1-21 Kyonan-cho,  
Musashino-shi, Tokyo 180  
Phone: 0422-32-4500  
Fax: 0422-31-2050

**Japan**  
Systems Marketing, Inc.  
Fukui Bldg. 2-2-12  
Sotokanda, Chiyoda-Ku  
Tokyo 101  
Phone: 03-32 54 27 51  
Fax: 03-32 54 32 88

**Japan**  
Trancy INC  
New Heights Aoyama 203  
1-1-10 Shibuya,  
Shibuya-Ku Tokyo 150  
Phone: +81-3-3486-7211  
Fax: +81-3-3486-7214

**Korea**  
Asea Brown Boveri Ltd.  
Oksan Bldg. 5-9 Fl.  
157, Samsung-Dong,  
Kangnam-Ku, Seoul 135-090  
Phone: 2-52 83 062  
Fax: 2-52 83 091

**Korea**  
Kisung International Co. Ltd.  
A-7-121, 604-1  
Kuro-Dong, Kuro-Ku, Seoul  
Phone: 02-679 7348  
Fax: 02-675 1404

**Korea**  
Daan Electronic Co., Ltd.  
Daan Bldg, 4F  
22-1 Singye-Dong,  
Yongsan-Ku, Seoul  
Phone: 02-822-718-8033  
Fax: 02-822-718 1160+1161

**Singapore**  
Practical Electronics Pte. Ltd.  
1 Rochor Canal Rd  
# 02-57, Sim Lim Square  
Singapore 0718  
Phone: 3-38 73 88  
Fax: 3-38 16 88

**South Africa**  
ABB Industry (Pty) Ltd. Drives  
P.O. Box 11494, Randhart 1457  
Phone: 011-8 64 53 40  
Fax: 011-9 08 20 61

**South Africa**  
Avnet Kopp (Pty) Ltd  
P. O. Box 3853, Rivonia, 2128  
South Africa.  
Phone: +27 11 444 2333  
Fax: +27 11 444 7778

**Taiwan**  
Industrade Co., Ltd.  
6F, No. 64, Section 2  
Chung Cheng Road  
Shihlin, Taipei, Taiwan 111  
Phone: 886-2-836 90 11  
Fax: 886-2-835 30 37

Sept. 97