

UGF8AT THRU UGF8DT

ULTRAFAST EFFICIENT PLASTIC RECTIFIER

Reverse Voltage - 50 to 200 Volts Forward Current - 8.0 Amperes

ITO-220AC

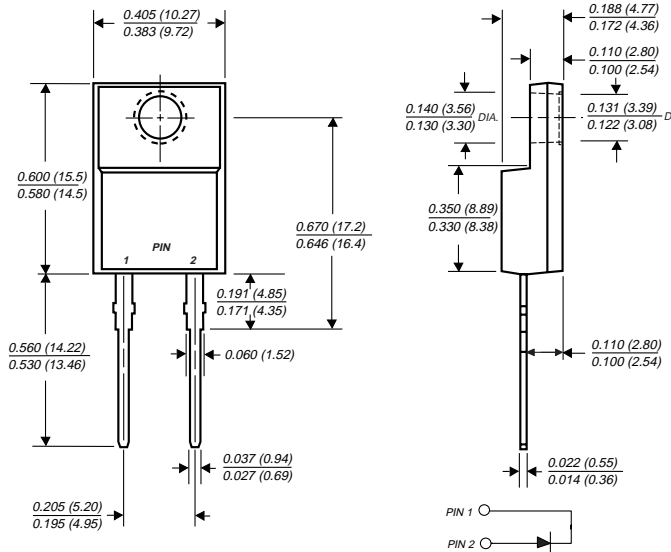

Dimensions in inches and (millimeters)

FEATURES

- ◆ Plastic package has Underwriters Laboratories Flammability Classification 94V-0
- ◆ Ideally suited for use in very high frequency switching power supplies, inverters and as a free wheeling diode
- ◆ Ultrafast reverse recovery time for high efficiency
- ◆ Soft recovery characteristics
- ◆ Excellent high temperature switching
- ◆ Glass passivated chip junction
- ◆ High temperature soldering guaranteed: 250°C, 0.25" (6.35mm) from case for 10 seconds

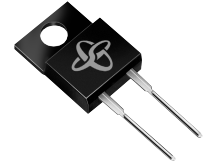

MECHANICAL DATA

Case: ITO-220AC molded plastic body

Terminals: Plated axial leads, solderable per MIL-STD-750, Method 2026

Polarity: As marked

Mounting Position: Any

Weight: 0.08 ounce, 2.24 grams

Mounting Torque: 5in. - lbs. max.

MAXIMUM RATINGS AND CHARACTERISTICS

Ratings at 25°C ambient temperature unless otherwise specified.

	SYMBOLS	UGF8AT	UGF8BT	UGF8CT	UGF8DT	UNITS
Maximum repetitive peak reverse voltage	V _{RRM}	50	100	150	200	Volts
Maximum RMS voltage	V _{RMS}	35	70	105	140	Volts
Maximum DC blocking voltage	V _{DC}	50	100	150	200	Volts
Maximum average forward rectified current at T _C =100°C	I _(AV)	8.0				Amps
Peak forward surge current 8.3 ms single half sine-wave superimposed on rated load (JEDEC Method) at T _C =100°C	I _{FSM}	150.0				Amps
Maximum instantaneous forward voltage at 8.0 20A 5.0A, T _J =150°C	V _F	1.00 1.20 0.95				Volts
Maximum DC reverse current at rated DC blocking voltage	I _R	10.0 300.0				μA
Maximum reverse recovery time (NOTE 1)	t _{rr}	20.0				ns
Maximum reverse recovery time (NOTE 2)	t _{rr}	30.0 50.0				ns
Maximum recovered stored charge (NOTE 2)	Q _{rr}	20.0 45.0				nC
Typical junction capacitance (NOTE 3)	C _J	45.0				pF
Typical thermal resistance (NOTE 4)	R _{θJC}	5.0				°C/W
Operating junction and storage temperature range	T _J , T _{STG}	-55 to+150				°C

NOTES: (1) Reverse recovery test conditions: I_F=0.5A, I_R=1.0A, I_{rr}=0.25A

(2) T_{rr} and Q_{rr} measured at I_F=8.0A, V_R=30V, di/dt=50A/μs, I_{rr}=10% I_{RM} for measurement of t_{rr}

(3) Measured at 1.0 MHz and applied reverse voltage of 4.0 Volts

(4) Thermal resistance from junction to case

RATINGS AND CHARACTERISTIC CURVES UGF8AT THRU UGF8DT

FIG. 1 - FORWARD CURRENT DERATING CURVE

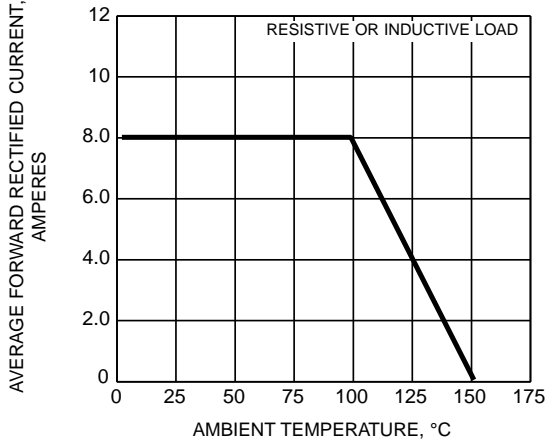

FIG. 2 - MAXIMUM NON-REPETITIVE PEAK FORWARD SURGE CURRENT

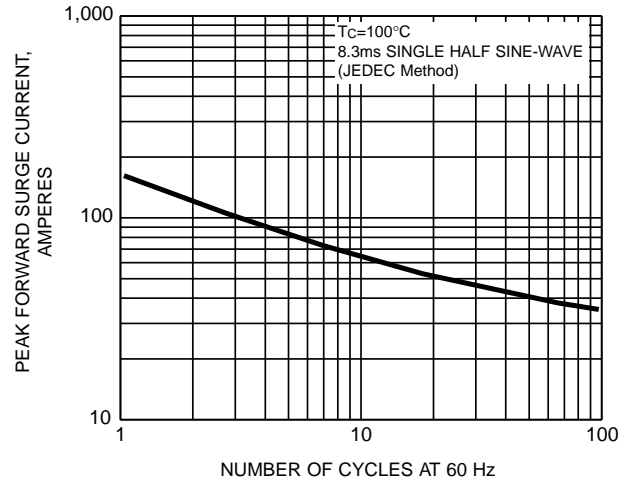

FIG. 3 - TYPICAL INSTANTANEOUS FORWARD CHARACTERISTICS

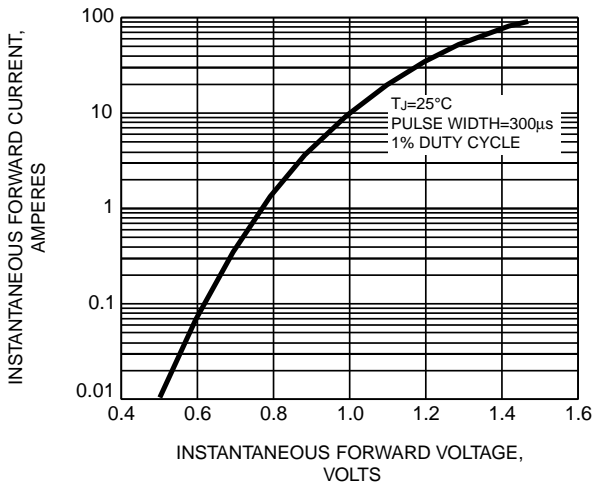

FIG. 4 - TYPICAL REVERSE CHARACTERISTICS

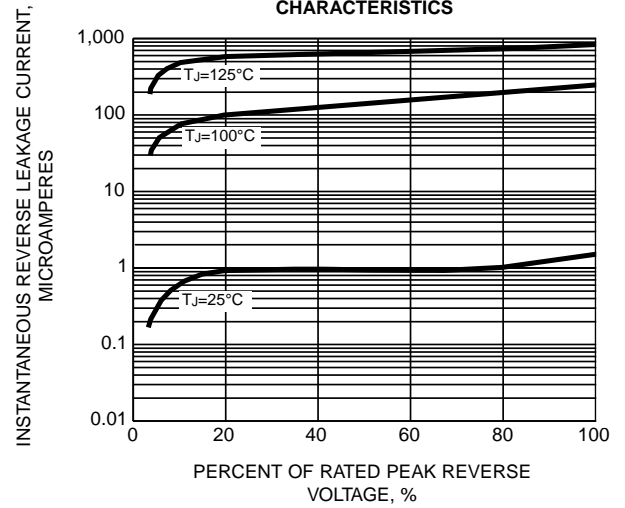

FIG. 5 - REVERSE SWITCHING CHARACTERISTICS

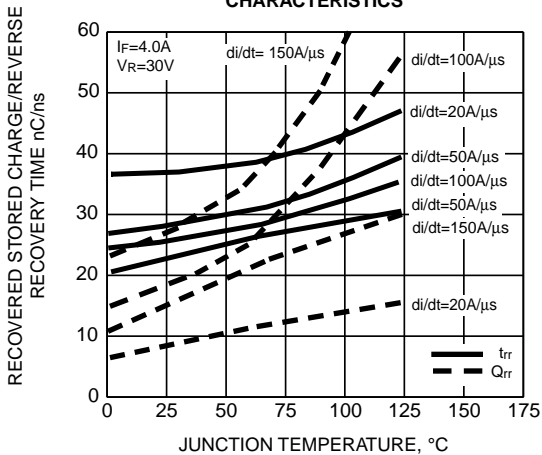

FIG. 6 - TYPICAL JUNCTION CAPACITANCE

